

SERVICE MANUAL MIX5 CHASSIS

<u>MODEL</u>	<u>COMMANDER</u>	<u>DEST.</u>	<u>CHASSIS NO.</u>	<u>MODEL</u>	<u>COMMANDER</u>	<u>DEST.</u>	<u>CHASSIS NO.</u>
KDF-E42A10	RM-YD003	USA					
KDF-E42A10	RM-YD003	CANADA					
KDF-E42A10	RM-YD003	MEXICO					
KDF-E50A10	RM-YD003	USA					
KDF-E50A10	RM-YD003	CANADA					
KDF-E50A10	RM-YD003	MEXICO					

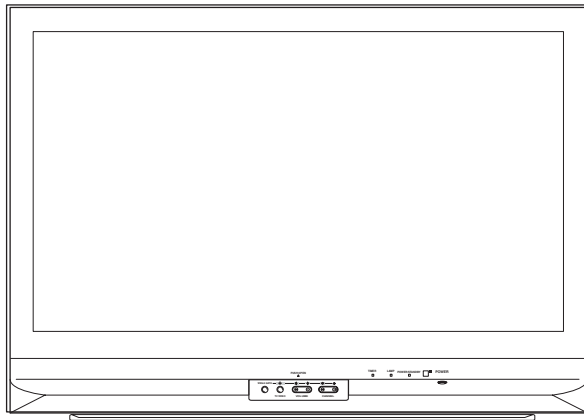

KDF-E42A10/E50A10



RM-YD003

LCD PROJECTION TV

SONY®

Specifications

Projection System	3 LCD Panels, 1 lens projection system	
LCD Panel	0.73 inch TFT LCD panel (1,280 · 720 pixels)	
Projection Lens	High Performance, large diameter hybrid lens F2.4	
Antenna	75-ohm external terminal for VHF/UHF	
Lamp	100W, XL-2400	
Television System	NTSC	American TV Standard
	ATSC (8VSB terrestrial)	ATSC compliant 8VSB
	QAM on cable	ANSI/SCTE 07 2000
Visible Screen Size (Picture measured diagonally)	KDF-E42A10: 42 inches KDF-E50A10: 50 inches	
Channel Coverage	Terrestrial (analog)	2-69
	Cable TV (analog)	1-125
	Terrestrial (digital)	2-69
	Cable TV (digital)	1-135
Number of Inputs/Outputs		
HDMI IN	Video	1080i, 720p, 480p, 480i
	Audio	Two channel linear PCM 32, 44.1 and 48 kHz, 16, 20 and 24 bit
Video (IN)	3 total (1 on side panel)	1 Vp-p, 75 ohms unbalanced, sync negative
S Video (IN)	1	Y: 1 Vp-p, 75 ohms unbalanced, sync negative
		C: 0.286 Vp-p (Burst signal), 75 ohms
Audio (IN)	5 total (1 on side panel)	500 mVrms (100% modulation)
		Impedance: 47 kilohms
Component Video Input	2 (Y Pb/Cb Pr/Cr)	Y: 1 Vp-p, 75 ohms unbalanced, sync negative
		Pb/Cb: 0.7 Vp-p, 75 ohms
		Pr/Cr: 0.7 Vp-p, 75 ohms
AUDIO (VAR/FIX) OUT	1	500 mVrms at the maximum volume setting (Variable)
		500 mVrms (Fixed)
		Impedance (output): 2 kilohms
 AUDIO OUT jacks are operable only when the TV's Speaker is set to 0 ff.		
RF Inputs	2	
PC Input	1	
Digital Audio Optical Output (PCM/Dolby Digital)	1	Optical Rectangular (1)
CableCARD Slot	PCMCIA Type I/II	
Speaker output	12 W + 12 W	
Power requirement	120 V, 60 Hz	
Power consumption	In use: 210 W	
	In standby: Less than 17 W	

Dimensions (W/H/D)	KDF-E42A10: 999 · 722 · 357 mm (39 ³ / ₈ · 28 ¹ / ₂ · 14 ¹ / ₈ inches) KDF-E50A10: 1184 · 827 · 408 mm (46 ⁵ / ₈ · 32 ⁵ / ₈ · 16 ¹ / ₈ inches)
Mass	KDF-E42A10: 28 kg (61 lb. 12 oz.) KDF-E50A10: 33 kg (72 lb. 13 oz.)
Supplied Accessories	
Remote Control	RM-YD003
AA (R6) Batteries	2 supplied for remote control
Operating Instructions	1
Quick Setup Guide	1
Warranty Card	1
Product Registration Card	1

Optional accessories:

- HDMI cable
- HDMI-to-DVI cable
- Component video cable
- S VIDEO cable
- A/V cable
- Audio cable
- Optical cable
- TV Stand : (SU-RG11S for KDF-E42A10, SU-RG11M for KDF-E50A10)
- Theatre Stand System: RHT-G2000
- Lamp : XL-2400

 **The availability of optional accessories depends on stock.**

Design and specifications are subject to change without notice.
Non-metric weights and measures are approximate.

Indicators

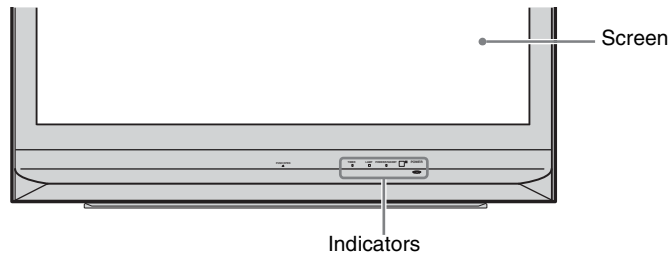

The indicators show the current status of your TV. If there is a change in the condition or a problem with the TV, the indicators will flash or light up in the manner described below to let you know that it requires your attention.

<i>Indicator</i>	<i>Flashing because...</i>
POWER/ STANDBY flashing	green : The lamp for the light source is preparing to turn on. When it is ready, it turns on. red : The lamp door or the lamp is not securely attached. The red indicator will continue to flash in intervals of three blinks at a time until the lamp door or the lamp is placed correctly. When the lamp door or the lamp is securely attached, the TV will turn on with green indicator.
LAMP indicator flashes	The projection lamp has burned out. Replace it with new one (see page 86).
TIMER indicator is lit	When one of the timers is set, the indicator will remain lit (will not flash) even when the TV is turned off.

Projection Lamp

Your TV uses a projection lamp as its light source. As with any lamp, it has lifespan and needs to be replaced when the Lamp indicator flashes or the screen becomes darker. Note the following:

- After turning on your TV, it may take a while (1 minute or less) before the picture appears.
- When the projection lamp wears out, the screen goes dark. Replace the lamp with a new Sony XL-2400 replacement lamp (not supplied).

 **The light emitted from the lamp is quite bright when your TV is in use. To avoid eye discomfort or injury, do not look into the light housing when the power is on.**

Replacing the Lamp

The projection lamp, which illuminates the picture, has a limited life.

If the screen becomes dark, the color looks unusual, or the LAMP indicator on the front of the TV flashes, it is time to replace the lamp with a new one (not supplied).

 **WARNING**

Electric appliances can cause fire or high temperature, resulting in injury or death. Be sure to follow the instructions below.

- Use a Sony XL-2400 replacement lamp (not supplied) for replacement. Use of any other lamp may damage the TV.
- Do not remove the lamp for any purpose other than replacement. Doing so may cause injury or fire.
- Do not put flammable materials and metal objects inside the lamp receptacle of the TV after removing the lamp. Doing so may cause fire or electrical shock. Do not touch the lamp receptacle once the lamp has been removed.
- When the lamp eventually burns out, you may hear a noticeable pop sound. This is normal and it is inherent to this type of lamp.
- In rare instances, the bulb may pop inside the lamp unit, but the lamp unit is designed to contain all of the broken glass pieces inside the lamp unit.
- The lamps contain mercury. For proper disposal of the used lamps, follow and observe the local ordinances. See page 89.

How to Replace the Lamp

- 1** Turn off the power on the main unit. Wait several minutes, then unplug the power cord.
(The cooling fan will continue to operate for about two minutes after turning the power off.)
- 2** Wait at least 30 minutes after unplugging the power cord to allow the lamp to cool down before replacing it. To avoid being burned, do not touch the lamp receptacle once the lamp has been removed.
- 3** Take the new lamp out of the box.
Do not touch the glass portion of the new lamp.

 **Do not shake the lamp. Vibration can damage the lamp or shorten its life.**

 **Avoid touching the front glass of a new lamp or the glass of the lamp receptacle. This may reduce picture quality or lamp life.**

- 4** Remove the outside lamp cover.

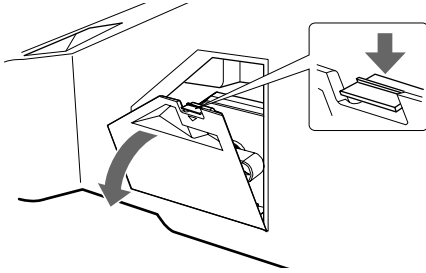

- 5** Remove the lamp door.

Turn the knob counterclockwise to OPEN and pull out the cover.

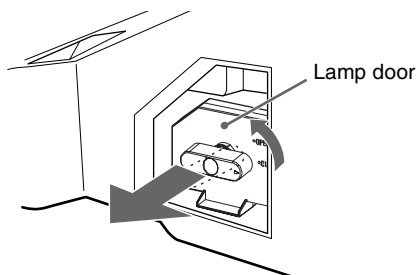

- 6** Pull out the lamp.

Hook a finger through the loop of the lamp handle and pull the handle upwards. Then pull the lamp straight out.

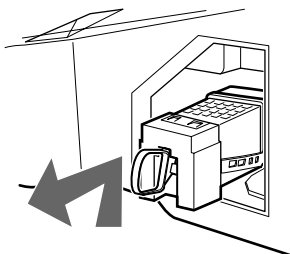

 **The lamp is very hot immediately after use. Never touch the glass portion of the lamp or the surrounding parts.**

 **After the used lamp has cooled, place it into the empty box of the replacement lamp. Never put the used lamp into a plastic bag.**

- 7** Put the new lamp into its place. Mount the new lamp securely. Failure to do so may cause a fire or the screen to go dark.

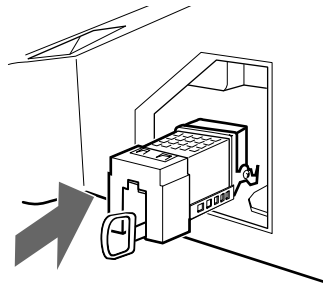

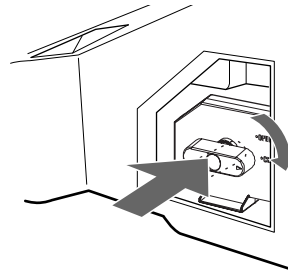

 **If the lamp is not securely reattached, the self-diagnostic function may be triggered and the POWER/STANDBY indicator flashes three times (see page 12).**

- 8** Reattach the lamp door. Turn the knob back to CLOSE and secure the cover.

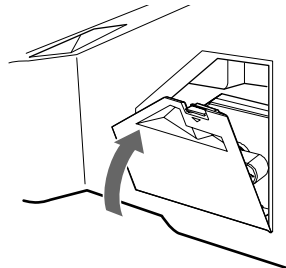

- 9** Put the outside lamp cover back in its place.



 **Consult your Sony dealer for a Sony XL-2400 replacement lamp.**

 **Take great care when replacing the lamp or plugging in/unplugging the connecting cords. Rough handling may cause the TV to fall, damaging the TV, the TV stand and the floor.**

The used lamp

This product contains mercury. Disposal of this product may be regulated if sold in the United States. For disposal or recycling information, please contact your local authorities or the Electronics Industries Alliance (<http://www.eiae.org>).

- Do not leave the used lamp near flammable materials or within the reach of children.
- Do not pour water onto the used lamp or put any object inside the lamp. Doing so may cause the lamp to burst.

For replacement lamp information visit:
U. S. residents: <http://www.sonystyle.com/tv/>
Canadian resident: <http://www.sonystyle.ca/tv/>

SAFETY CHECK-OUT

(US model only)

After correcting the original service problem, perform the following safety checks before releasing the set to the customer:

1. Check the area of your repair for unsoldered or poorly-soldered connections. Check the entire board surface for solder splashes and bridges.
2. Check the interboard wiring to ensure that no wires are "pinched" or contact high-wattage resistors.
3. Check that all control knobs, shields, covers, ground straps, and mounting hardware have been replaced. Be absolutely certain that you have replaced all the insulators.
4. Look for unauthorized replacement parts, particularly transistors, that were installed during a previous repair. Point them out to the customer and recommend their replacement.
5. Look for parts which, through functioning, show obvious signs of deterioration. Point them out to the customer and recommend their replacement.
6. Check the line cords for cracks and abrasion. Recommend the replacement of any such line cord to the customer.
7. Check the condition of the monopole antenna (if any). Make sure the end is not broken off, and has the plastic cap on it. Point out the danger of impalement on a broken antenna to the customer, and recommend the antenna's replacement.
8. Check the B+ and HV to see they are at the values specified. Make sure your instruments are accurate; be suspicious of your HV meter if sets always have low HV.
9. Check the antenna terminals, metal trim, "metallized" knobs, screws, and all other exposed metal parts for AC leakage. Check leakage as described below.

LEAKAGE TEST

The AC leakage from any exposed metal part to earth ground and from all exposed metal parts to any exposed metal part having a return to chassis, must not exceed 0.5mA (500 microampers). Leakage current can be measured by any one of three methods.

1. A commercial leakage tester, such as the Simpson 229 or RCA WT-540A. Follow the manufacturers' instructions to use these instruments.
2. A battery-operated AC milliammeter. The Data Precision 245 digital multimeter is suitable for this job.
3. Measuring the voltage drop across a resistor by means of a VOM or battery-operated AC voltmeter. The "limit" indication is 0.75V, so analog meters must have an accurate low-voltage scale. The Simpson 250 and Sanwa SH-63Trd are examples of a passive VOM that is suitable. Nearly all battery-operated digital multimeters that have a 2V AC range are suitable. (See Fig. A)

HOW TO FIND A GOOD EARTH GROUND

A cold-water pipe is guaranteed earth ground; the cover-plate retaining screw on most AC outlet boxes is also at earth ground. If the retaining screw is to be used as your earth-ground, verify that it is at ground by measuring the resistance between it and a cold-water pipe with an ohmmeter. The reading should be zero ohms. If a cold-water pipe is not accessible, connect a 60-100 watt trouble light (not a neon lamp) between the hot side of the receptacle and the retaining screw. Try both slots, if necessary, to locate the hot side of the line, the lamp should light at normal brilliance if the screw is at ground potential. (See Fig. B)

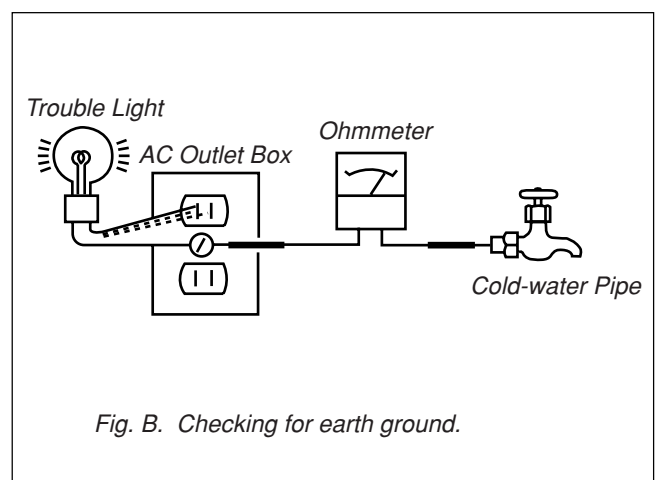
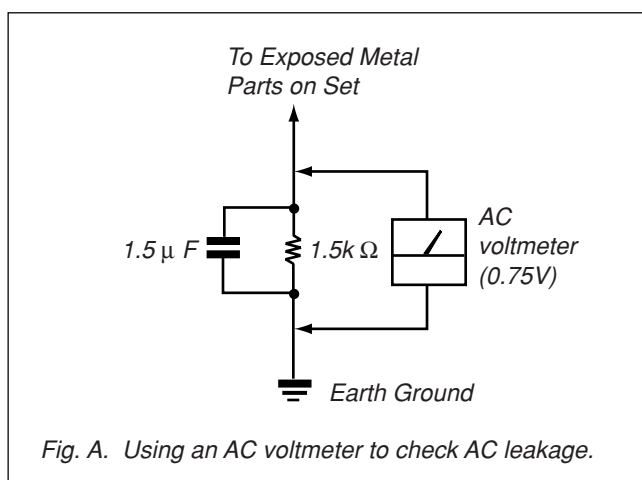

CAUTION

These servicing instructions are for use by qualified service personnel only.

To reduce the risk of electric shock, do not perform any servicing other than that contained in the operating instructions unless you are qualified to do so.

WARNING!!

AN ISOLATION TRANSFORMER SHOULD BE USED DURING ANY SERVICE TO AVOID POSSIBLE SHOCK HAZARD, BECAUSE OF LIVE CHASSIS. THE CHASSIS OF THIS RECEIVER IS DIRECTLY CONNECTED TO THE AC POWER LINE.

SAFETY-RELATED COMPONENT WARNING!!

COMPONENTS IDENTIFIED BY SHADING AND MARK \triangle ON THE SCHEMATIC DIAGRAMS, EXPLODED VIEWS AND IN THE PARTS LIST ARE CRITICAL TO SAFE OPERATION. REPLACE THESE COMPONENTS WITH SONY PARTS WHOSE PART NUMBERS APPEAR AS SHOWN IN THIS MANUAL OR IN SUPPLEMENTS PUBLISHED BY SONY. CIRCUIT ADJUSTMENTS THAT ARE CRITICAL TO SAFE OPERATION ARE IDENTIFIED IN THIS MANUAL. FOLLOW THESE PROCEDURES WHENEVER CRITICAL COMPONENTS ARE REPLACED OR IMPROPER OPERATION IS SUSPECTED.

ATTENTION!!

AFIN D'EVITER TOUT RISQUE DELECTROCUTION PROVENANT D'UN CHÂSSIS SOUS TENSION, UN TRANSFORMATEUR D'ISOLEMENT DOIT ETRE UTILISÉ LORS DE TOUT DEPANNAGE.

LE CHÂSSIS DE CE RECEPTEUR EST DIRECTEMENT RACCORDÉ À L'ALIMENTATION SECTEUR.

ATTENTION AUX COMPOSANTS RELATIFS À LA SÉCURITÉ!!

LES COMPOSANTS IDENTIFIÉS PAR UNE FRAME ET PAR UNE MAPQUE \triangle SUR LES SCHÉMAS DE PRINCIPE, LES VUES EXPLOSÉES ET LES LISTES DE PIÉCES SONT D'UNE IMPORTANCE CRITIQUE POUR LA SÉCURITÉ DU FONCTIONNEMENT. NE LES REMPLACER QUE PAR DES COMPOSANTS SONY DONT LE NUMÉRO DE PIÉCE EST INDIQUÉ DANS LE PRÉSENT MANUEL OU DANS DES SUPPLÉMENTS PUBLIÉS PAR SONY. LES RÉGLAGES DE CIRCUIT DONT L'IMPORTANCE EST CRITIQUE POUR LA SÉCURITÉ DU FONCTIONNEMENT SONT IDENTIFIÉS DANS LE PRÉSENT MANUEL. SUIVRE CES PROCÉDURES LORS DE CHAQUE REMPLACEMENT DE COMPOSANTS CRITIQUES, OU LORSQU'UN MAUVAIS FONCTIONNEMENT SUSPECTÉ.

TABLE OF CONTENTS

<u>Section</u>	<u>Title</u>	<u>Page</u>	<u>Section</u>	<u>Title</u>	<u>Page</u>
1. SELF DIAGNOSIS FUNCTION		11			
				2-24-14. Pull Out Some Blocks (7)	27
				2-24-15. Pull Out Some Blocks (8)	28
				2-24-16. Pull Out Some Blocks (9)	28
				2-24-17. Pull Out Some Blocks (10)	28
				2-24-18. Remove Optics Unit	28
2. DISASSEMBLY			3. ELECTRICAL ADJUSTMENTS		
2-1.	Rear Cover	16	3-1.	Electrical Adjustment by Remote Commander	29
2-2.	Service Position	17	3-1-1.	Method of Setting the Service Adjustment Mode	29
2-3.	Antenna Switch, QU Block Assembly	18	3-1-2.	Service Mode Adjustment	29
2-4.	K Board	19	3-1-3.	Memory Write Confirmation Method	29
2-5.	Terminal Bracket	19	3-1-4.	Adjusting Buttons and Indicator	29
2-6.	HPC Board	19	3-2.	To read Lamp and Panel time	30
2-7.	B Block	20	3-3.	Test Reset	30
2-8.	OU Bracket	20			
2-9.	B Board	20	4. DIAGRAMS		
2-10.	B, QM and QT Boards	21	4-1.	Block Diagram (1)	31
2-11.	QT Board	21		Block Diagram (2)	32
2-12.	QM Board	21		Block Diagram (3)	33
2-13.	P Board	21		Block Diagram (4)	34
2-14.	AGU Board	22		Block Diagram (5)	35
2-15.	DC Fan	22		Block Diagram (6)	36
2-16.	Main Duct (R)	23		Block Diagram (7)	37
2-17.	Duch Block Assembly (Without Main Duct (R))	23	4-2.	Frame Schematic Diagram	38
2-18.	D.C. Fan (Sirocco)	23	4-3.	Circuit Boards Location	39
2-19.	Speaker Grill Block Assembly	23	4-4.	Schematic Diagrams	39
2-20.	HA and HB Boards	24	(1)	Schematic Diagram of GT Board	40
2-21.	Screen Frame Block Assembly	24	(2)	Schematic Diagram of HA Board	41
2-22.	Speakers	24	(3)	Schematic Diagram of HB Board	42
2-23.	Rear Cover (With Mirror)	24	(4)	Schematic Diagram of HC Board	43
2-24.	How to Replace Optics Unit	25	(5)	Schematic Diagram of K Board	44
2-24-1.	Remove Lamp Bloxk (1)	25	(6)	Schematic Diagram of QT (1/3) Board	45
2-24-2.	Remove Lamp Bloxk (2)	25	(7)	Schematic Diagram of QT (2/3) Board	46
2-24-3.	Remove Lamp Bloxk (3)	25	(8)	Schematic Diagram of QT (3/3) Board	47
2-24-4.	Remove Cover, Rear (1)	25	(9)	Schematic Diagram of QU Board	48
2-24-5.	Remove Cover, Rear (1-2)	25	(10)	Schematic Diagram of S2 Board	49
2-24-6.	Remove Cover, Rear (2)	25	(11)	Schematic Diagram of T1 Board	50
2-24-7.	Remove Stay (L), Side	26	(12)	Schematic Diagram of T2 Board	51
2-24-8.	Pull Out Some Blocks (1)	26			
2-24-9.	Pull Out Some Blocks (2)	26			
2-24-10.	Pull Out Some Blocks (3)	26			
2-24-11.	Pull Out Some Blocks (4)	26			
2-24-12.	Pull Out Some Blocks (5)	27			
2-24-13.	Pull Out Some Blocks (6)	27			

<u>Section</u>	<u>Title</u>	<u>Page</u>
4-5.	Printed Wiring Boards	52
(1)	GT Board	52
(2)	HA, HB Boards	53
(3)	HC, K Boards	54
(4)	QT Board	55
(5)	QU Board	56
(6)	S2 Board	57
(7)	T1, T2 Boards	58
4-6.	Semiconductors	59

5. EXPLODED VIEWS

5-1.	Screen Mirror Block, Cover	60
5-2.	B Block, Chassis Assembly	61
5-3.	Lamp Duct Assembly, Optics Unit Block	62

6. ELECTRICAL PARTS LIST

•	GT Board	63
•	HA Board	65
•	HB Board	65
•	HC Board	66
•	HPC Board	66
•	K Board	67
•	QT Board	69
•	QU Board	71
•	S2 Board	71
•	T1 Board	71
•	T2 Board	71

SECTION 1

SELF DIAGNOSIS FUNCTION

1. Summary of Self-Diagnosis Function

- This device includes a self-diagnosis function.
- In case of abnormalities, the POWER/STANDBY indicator automatically blinks. It is possible to predict the abnormality location by the number of blinks. The Instruction Manual describes blinking of the POWER/STANDBY indicator.
- If the symptom is not reproduced sometimes in case of a malfunction, there is recording of whether a malfunction was generated or not. Operate the remote command to confirm the matter on the screen and to predict the location of the abnormality.

2. Diagnosis Items and Prediction of Malfunction Location

- When a malfunction occurs the POWER/STANDBY indicator only blinks for one of the following diagnosis items. In case of two or more malfunctions, the item which first occurred blinks. If the malfunctions occurred simultaneously, the item with the lower blink count blinks first.
- The screen display displays the results regarding all the diagnosis items listed below. The display "0" means that no malfunctions occurred.

Diagnosis Item	Number of times POWER/STANDBY indicator blinks	Probable Cause Location	Defected symptoms
Temp error	2 times	- Set temperture is high. - Temp sensor connector is not attached securely. (CN7020 on HB board, CN7180 on S2 board)	- No picture/No sound
Lamp cover error	3 times	- Lamp cover is not attached securely. -Lamp is not set securely.	- No picture/No sound
Fan stopped	4 times	- Fan 1-4 power is not supplied. (AGU board) - Fan connector is not attached securely. -Fan caught wires or harnesses.	- No picture/No sound
Lamp driver error	5 times	- Lamp driver is faulty.	- No picture/No sound
Low B error	6 times	- B_12V is not supplied. (GT board)	- No picture/No sound
Audio error	7 times	- Short-circuit of Audio power supply line. -Blow out of fuse. (PS3001 on K board) -IC failure. (IC3005 on K board)	- No picture/No sound
D-OVP error	8 times	-B -12V is over voltage. (B board)	- No picture/No sound
ATSC OVP	10 times	-Q_10.5V is over voltage. (GT board)	- No picture/No sound
Lamp error	LAMP-LED flashes	- Lamp for the light source burns out.	- No picture/No sound

3. Blinking count display of POWER/STANDBY indicator

- One blink is not used for self-diagnosis.

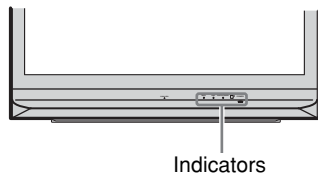

- Example

Diagnosis item LED blinks

Lamp cover 3 times

Fan 4 times

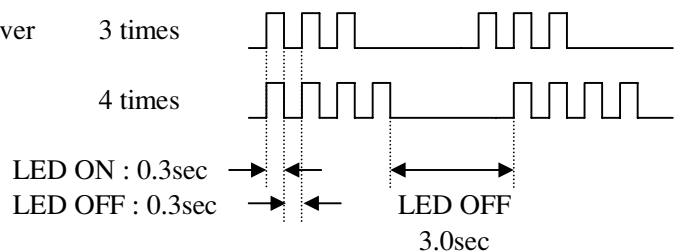

- Release of POWER/STANDBY indicator blinking

The POWER/STANDBY indicator blinking display is released by removing the plug from the power or leaving for 2 minutes.

4. Self-diagnosis screen displays

- In cases of malfunctions where it is not possible to determine the symptom such as when the power goes off occasionally or when the screen disappears occasionally, there is a screen display on whether the malfunction occurred or not in the past (and whether the detection circuit operated or not) in order to allow confirmation.

<Screen Display Method>

- Quickly press the remote command button in the following order from the standby state.

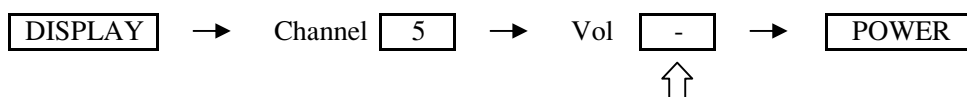

Be aware that this differs from the method of entering the service mode (Vol +).

SELF CHECK		
1	: LAMP_ERROR	0
2	: TEMP_ERROR	0
2	: LAMP_TEMP	0
3	: LAMP_COVER	0
4	: FAN_ERROR	0
5	: LAMP_DRIVER	1
6	: LOWB_ERROR	0
7	: AUDIO_PROT	0
8	: D_OVP	0
10	: ATSC_OVP	0

- Numeral "1" means a fault was detected one time
- Numeral "0" means that no fault was detected

- The results display is not automatically cleared. In case of repairs and after repairs, check the self-diagnosis screen and be sure to return the results display to "0".
- If the results display is not returned to "0" it will not be possible to judge a new malfunction after completing repairs.

<Method of Clearing Results Display>

1. Power off (Set to the standby mode)

2. → Channel → Vol →

3. Channel →

<Method of Ending Self-Diagnosis Screen>

- When ending the self-diagnosis screen completely, turn the power switch OFF on the remote commander or the main unit.

5. Self-Diagnosis function operation

2	: Temp	When the temperature sensor on the S2 board detects high temperature, or IIC line connector (CN8410:AGU board, CN7180:S2 board) is not seated securely, the TV-micro turns off the lamp. When the temperature sensor on the HB board detects high temperature, or IIC line connector (CN8004:AGU board, CN7020:HB board) is not seated securely, the TV-micro turns off the lamp.
3	: Lamp cover	The rib at the back of the lamp cover closes the SW on the T1 board. The lamp closes the SW on the T2 board. It is monitored by the BE micro (pin133 of IC4100) and turns off the lamp when it is opened.
4	: Fan	Fan rotation is detected by "FAN-PROT" and the TV-micro (pin 38 of IC8002) turns off the lamp when it is "high".
5	: Lamp Driver	When the "LAMP-PROT" (pin132 of IC4100) is high, the lamp is not turned on. If the "LAMP-HV-DET" (pin134 of IC4100) is low at the same time, it is classified as no high voltage of the lamp driver.
6	: Low B error	When no "B_12V" is detected, pin 128 of TV-micro is low and it turns off the main power.
7	: Audio	When DC voltage is detected at the speaker output, pin 149 of TV-micro is low and it turns off the main power.
8	: D-OVP	When overvoltage of "B_12V" is detected, pin 127 of TV-micro is low and it turns off the main power.
10	: ATSC-OVP	When overvoltage of "Q_10.5 V" is detected, pin 126 of TV-micro is low and it turns off the main power.
LAMP	: Lamp	When the "LAMP-PROT" (pin132 of IC4100) is high, the lamp is not turned on. If the "LAMP-HV-DET" (pin134 of IC4100) is high at the same time, it is classified as no lamp or a dead lamp.

BLOCK DIAGRAM

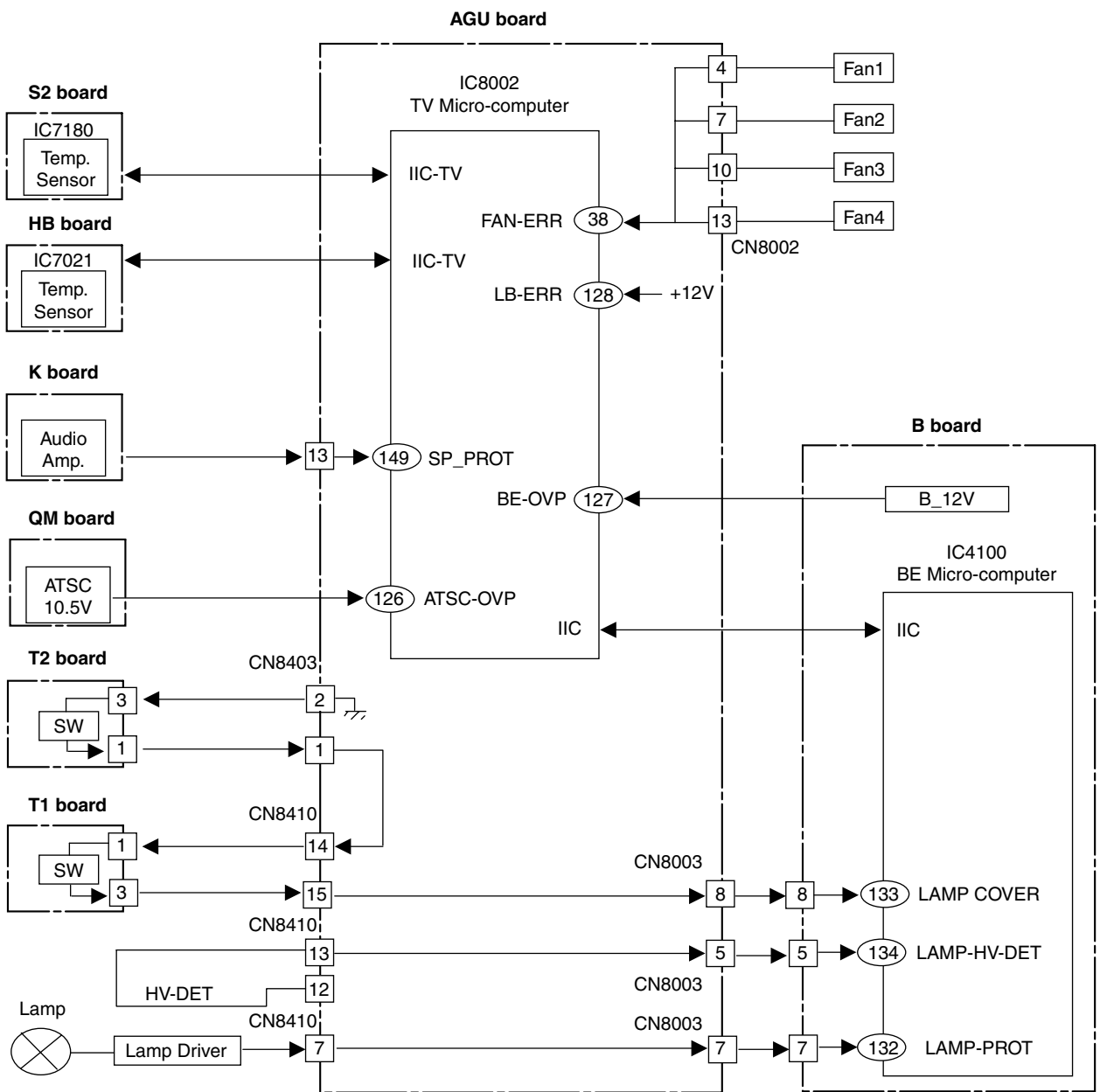

Reading Lamp and Panel time

Use the following to determine the lamp and panel time of a set.

Screen Display Method

In standby mode, press the buttons on the Remote Commander sequentially, in rapid succession, as shown below:

1. Press **Display** → Channel **5** → Sound Volume **+** → Power ON

2. To enter BE-micro service menu, press JUMP 2 times.

CONFIGRATION	00	SERVICE
CP18_COLOR_SYS	00 00A0	BE Micro



Press Channel-4

3. To display the lamp time, press Channel-4.

The screen displays:

“ Total lamp time is 14 hours”

GW_SPECIAL	34	SERVICE
LAMP_TIME	02 00000014	BE Micro



Press Channel-4

4. To display the panel time, press Channel-4.

The screen displays:

“ Total panel time is 14 hours”

GW_SPECIAL	34	SERVICE
PANEL_TIME	01 00000014	BE Micro



Press Channel-5 7 times,
Channel-1

5. To display the lamp time clear, press Channel-5
7 times and Channel-1.

OPTION_E	20	SERVICE
LAMP	01 0000	BE Micro

To reset the lamp time press Channel-3 > MUTING > ENT.

WRITE (Character color is red) is momentarily displayed and the lamp time is reset to “0”.

Exiting Service Mode

After completing the changes exit service mode by turning off the set using the Remote Commander or the power switch.

SECTION 2 DISASSEMBLY

2-1. REAR COVER

E42A10

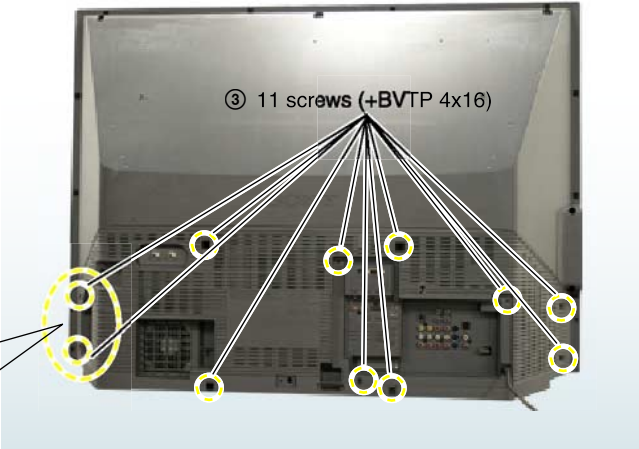

E50A10

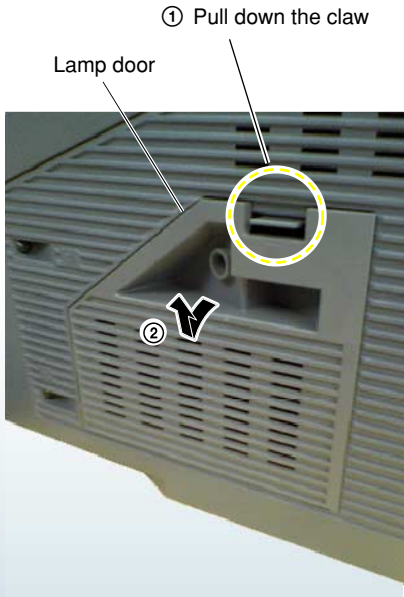
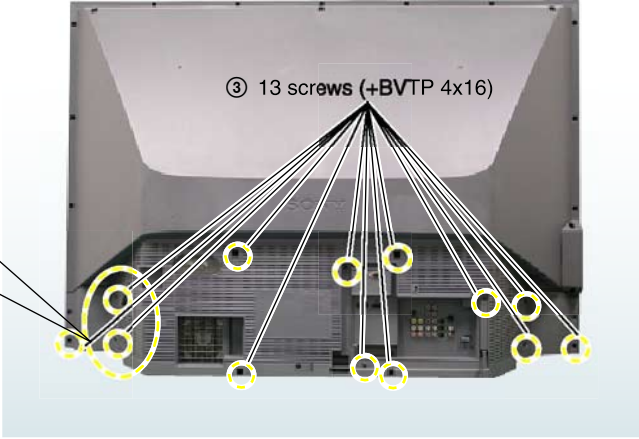

2-2. SERVICE POSITION

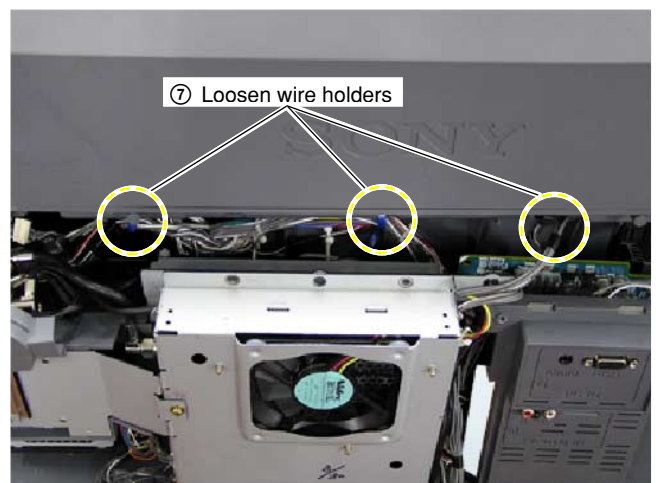
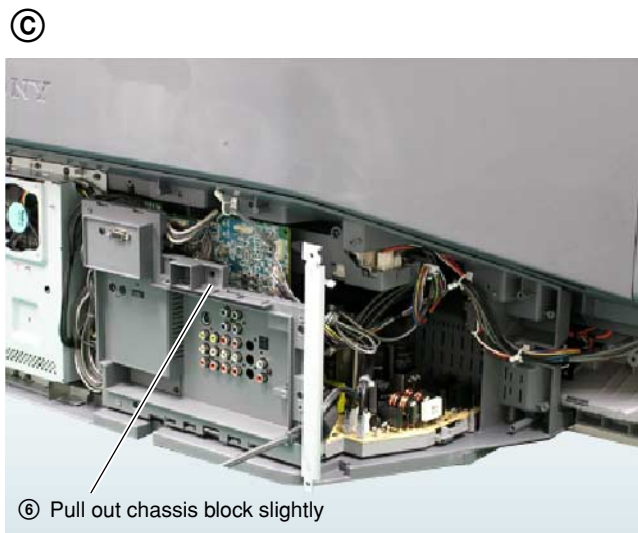
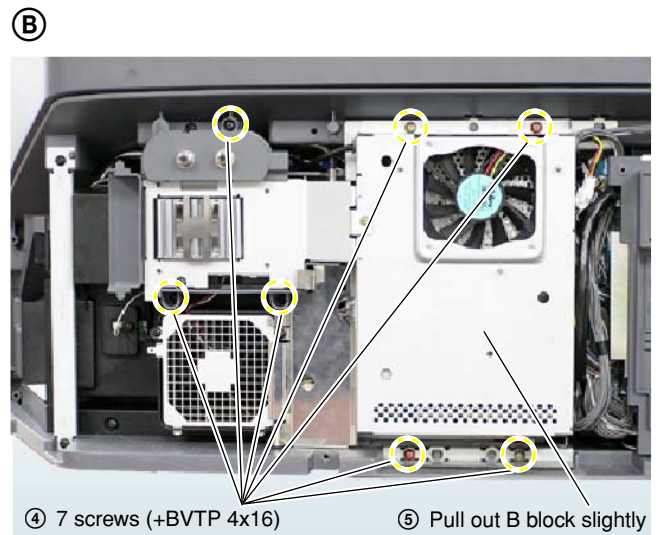
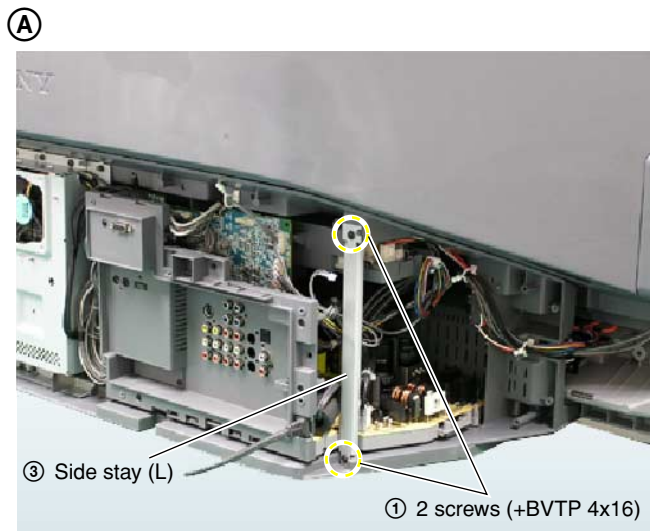
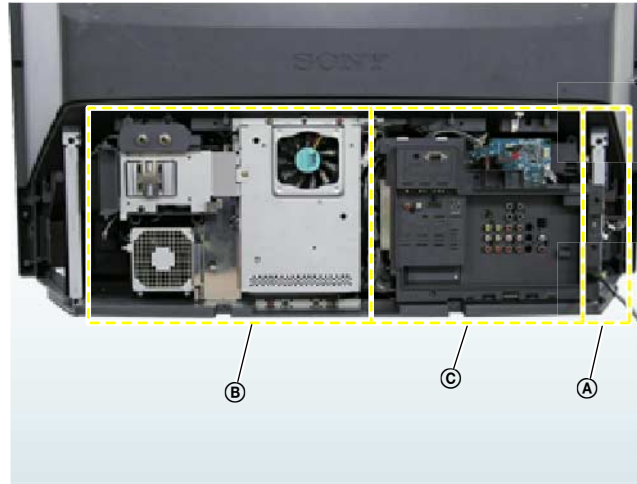

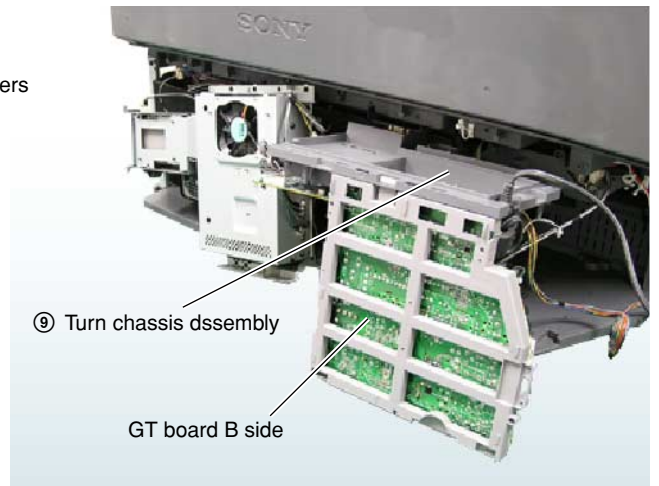
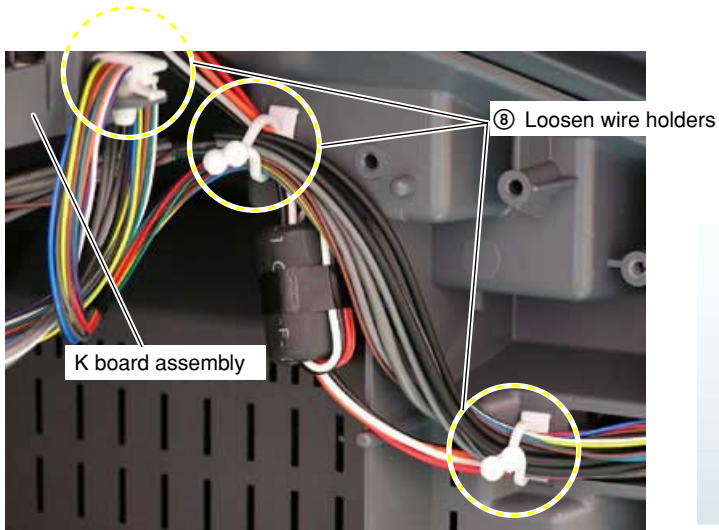

2-3. ANTENNA SWITCH, QU BLOCK ASSEMBLY

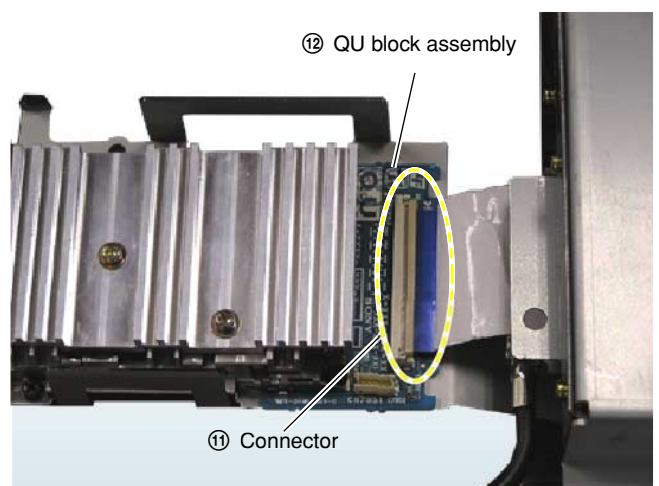
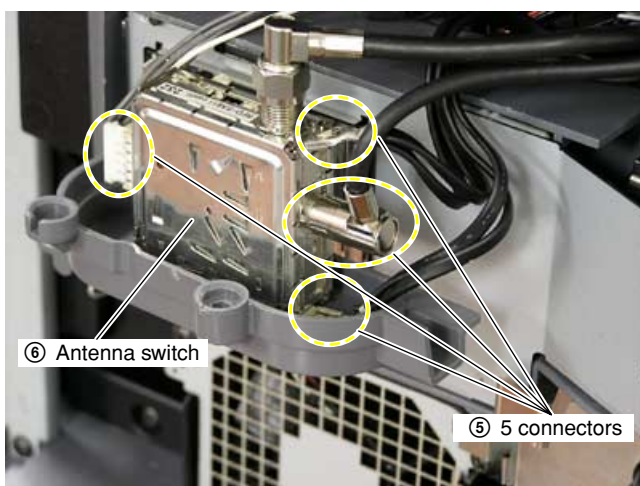
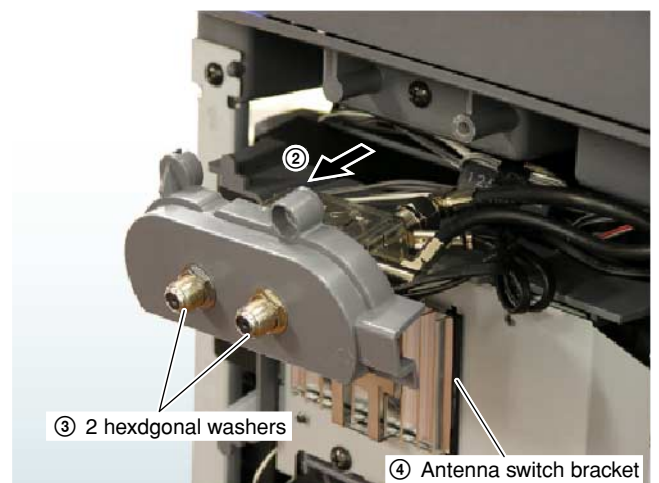
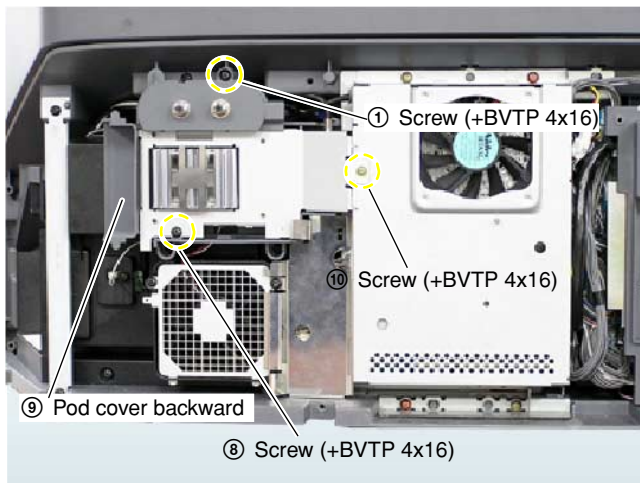

2-4. K BOARD

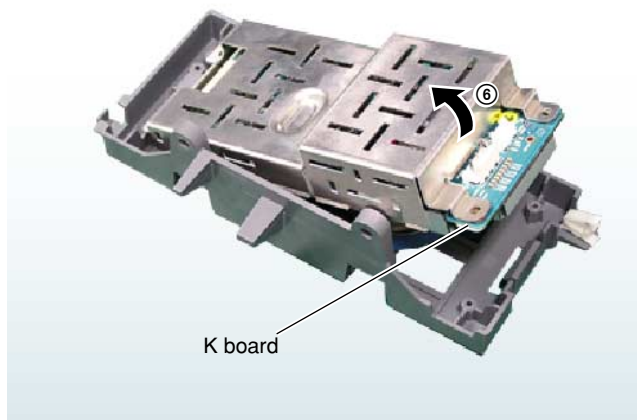
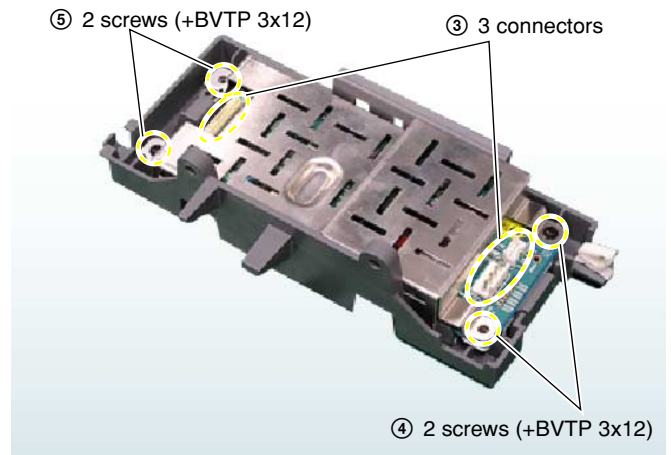
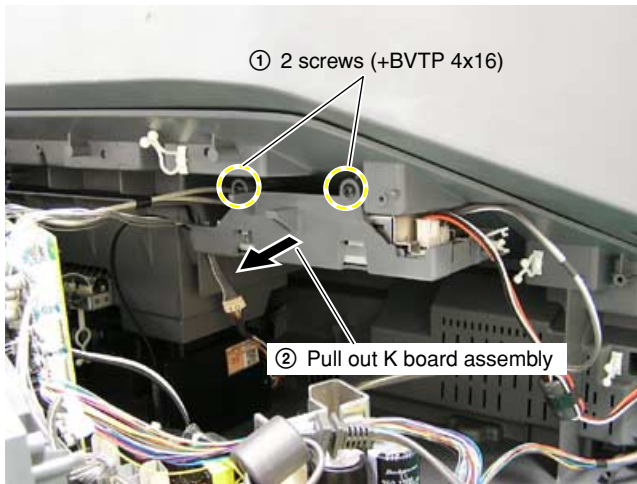

2-5. TERMINAL BRACKET

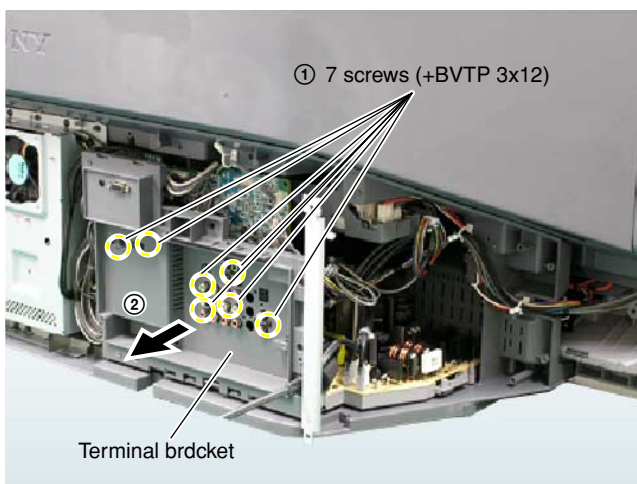

2-6. HPC BOARD

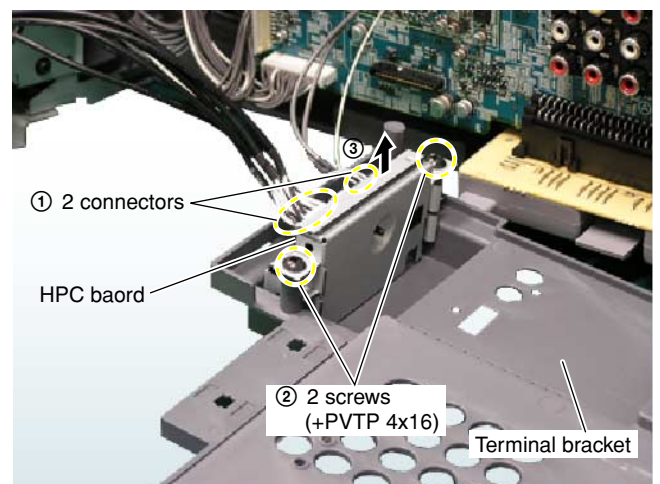

2-7. B BLOCK

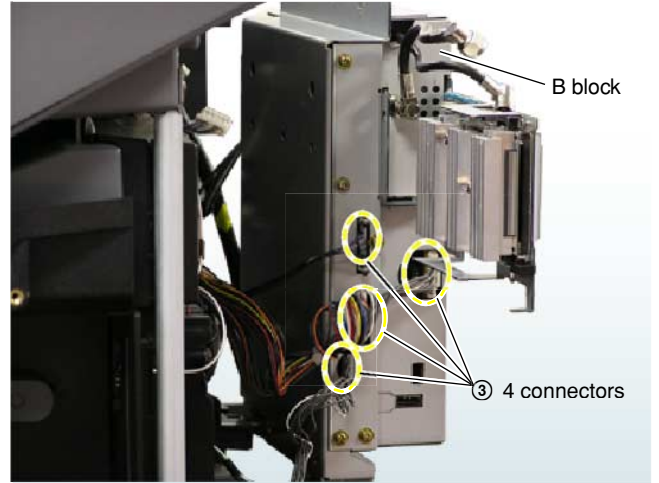
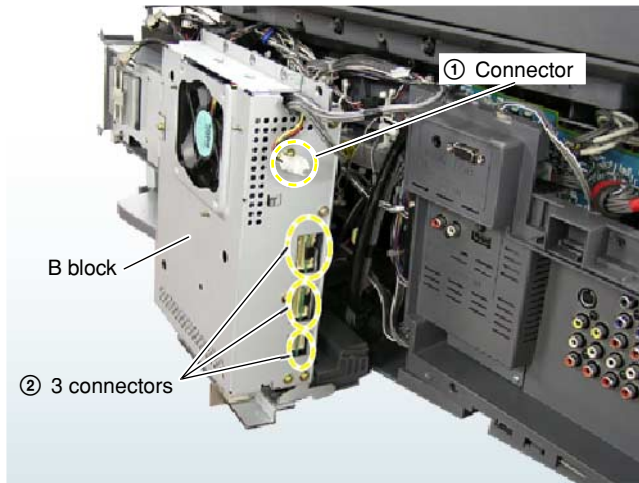

2-8. OU BRACKET

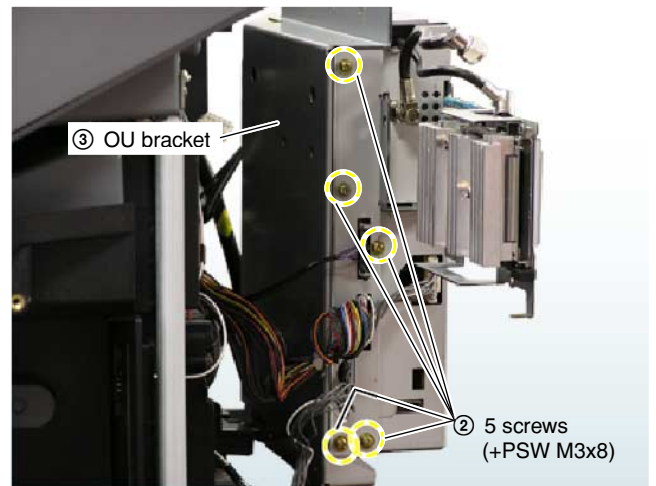
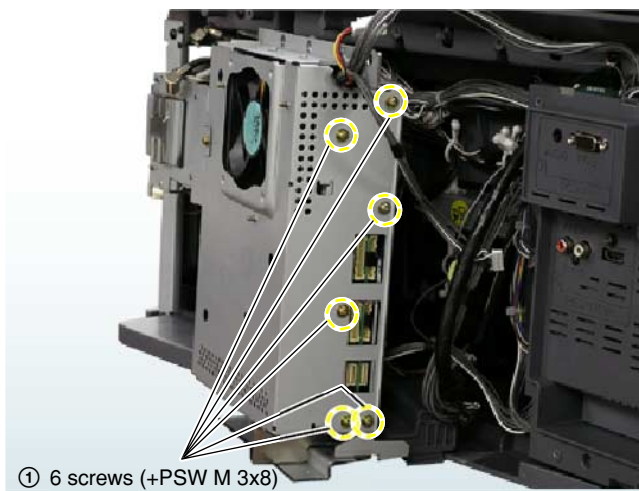

2-9. B BOARD

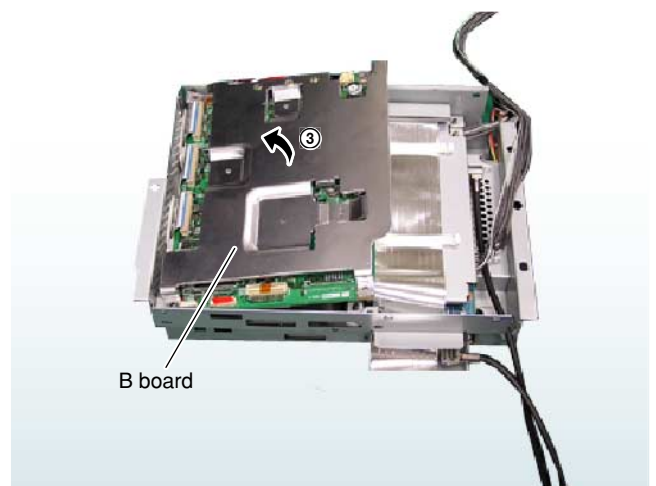
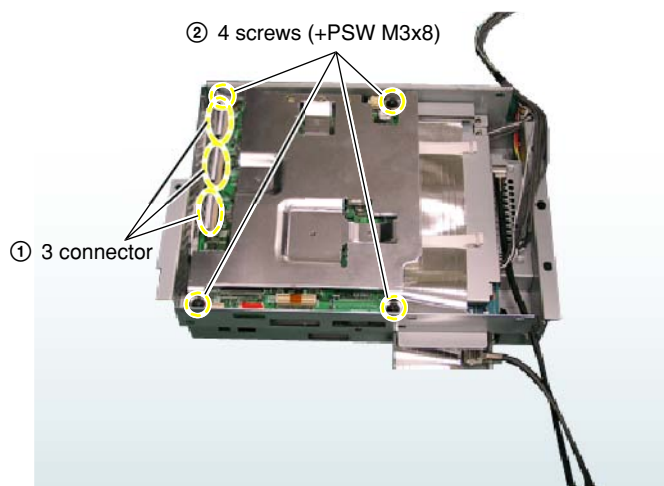

2-10. B, QM AND QT BOARDS

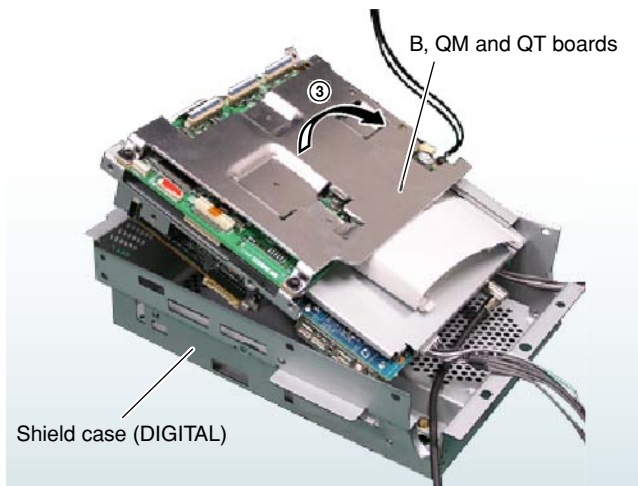

2-11. QT BOARD

① Place the pod bracket assembly upside down.

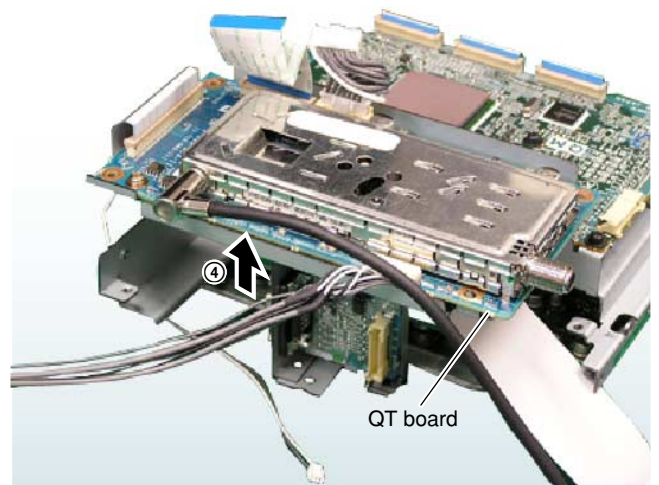
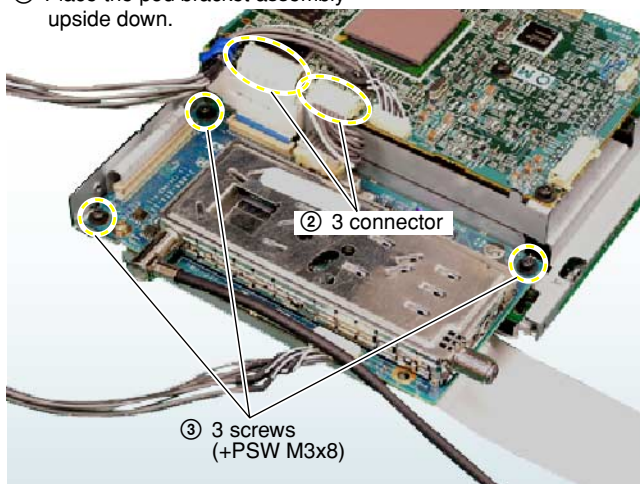

2-12. QM BOARD

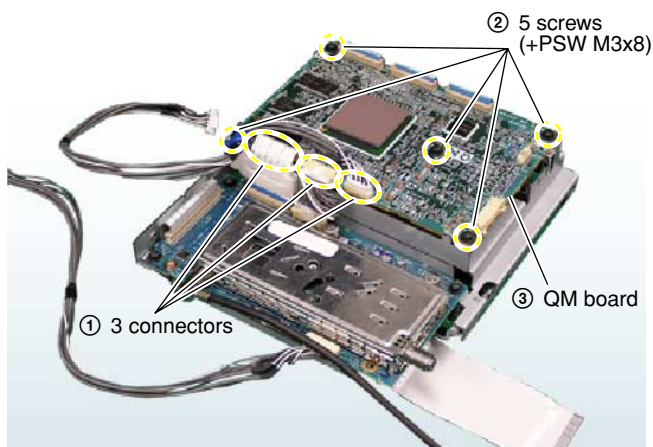

2-13. P BOARD

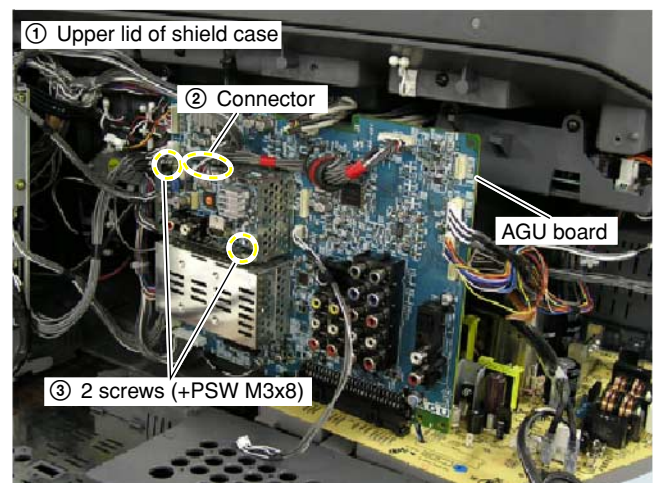

2-14. AGU BOARD

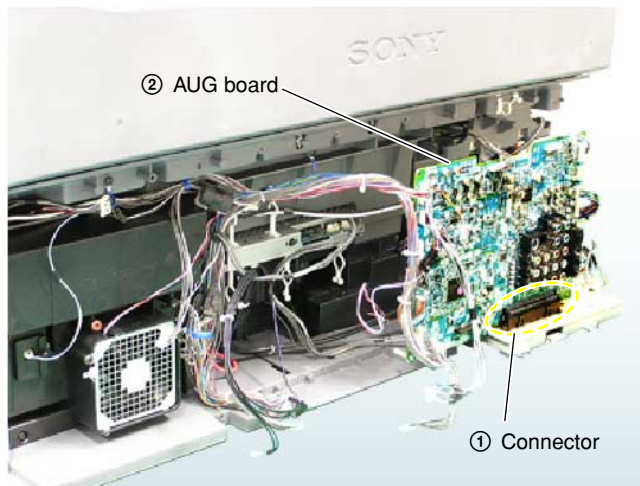

2-15. DC FAN

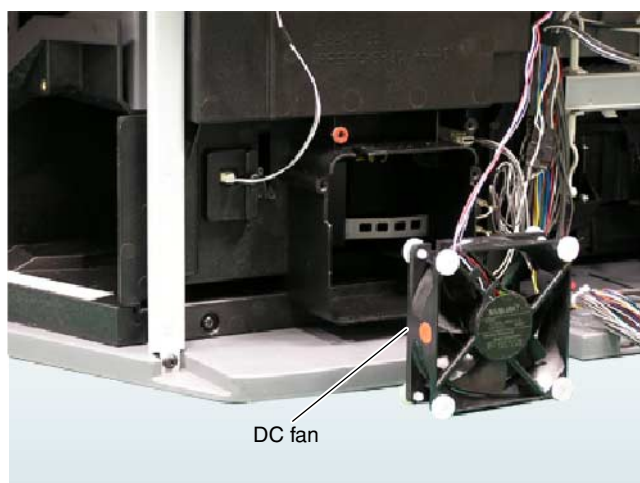
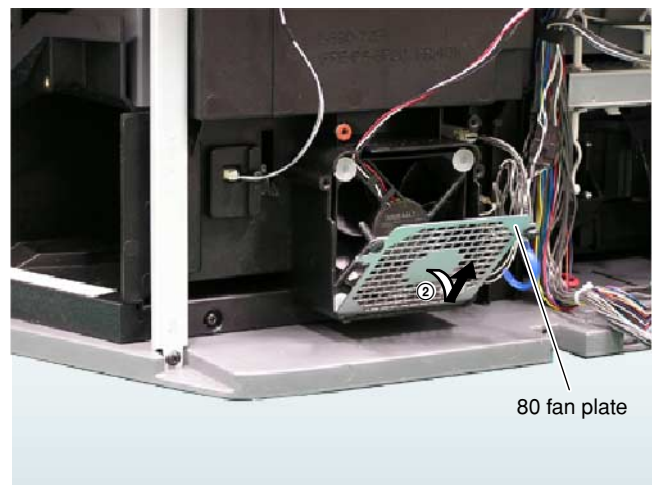
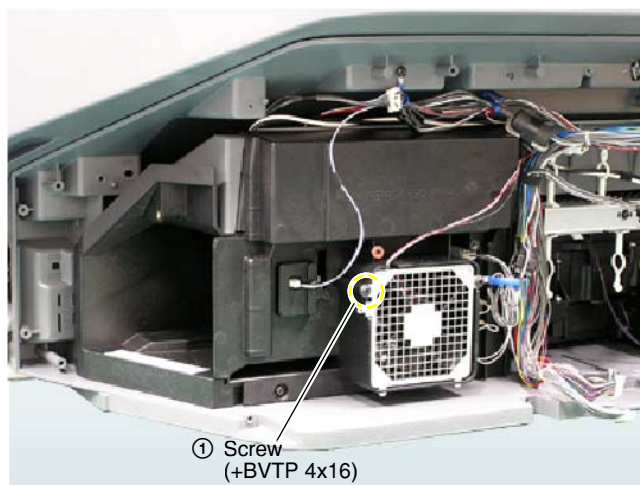

2-16. MAIN DUCT (R)

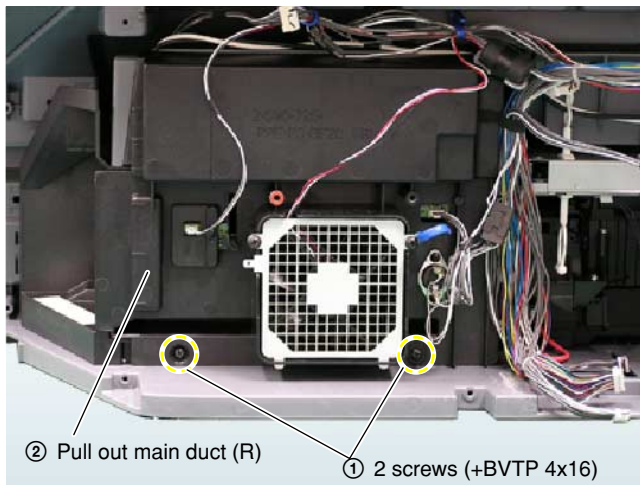

2-17. DUCT BLOCK ASSEMBLY (WITHOUT MAIN DUCT (R))

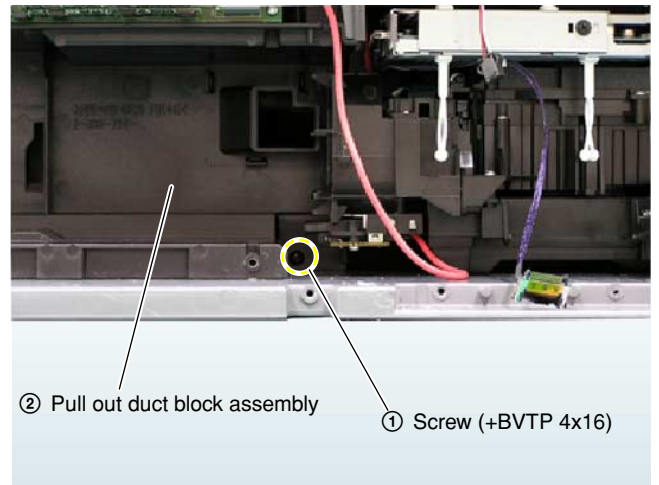

2-18. D.C. FAN (SIROCCO)

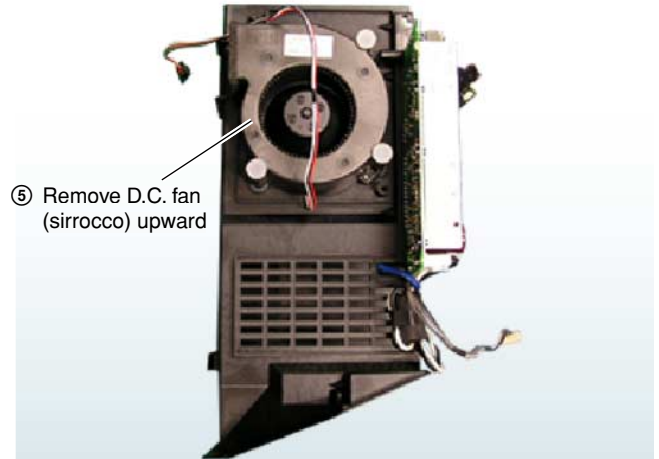
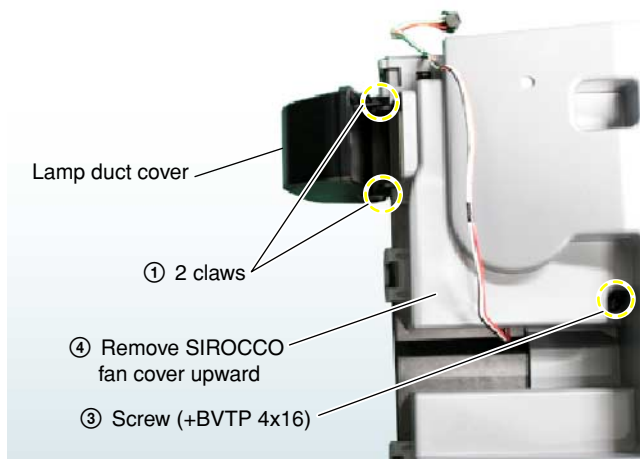

2-19. SPEAKER GRILL BLOCK ASSEMBLY

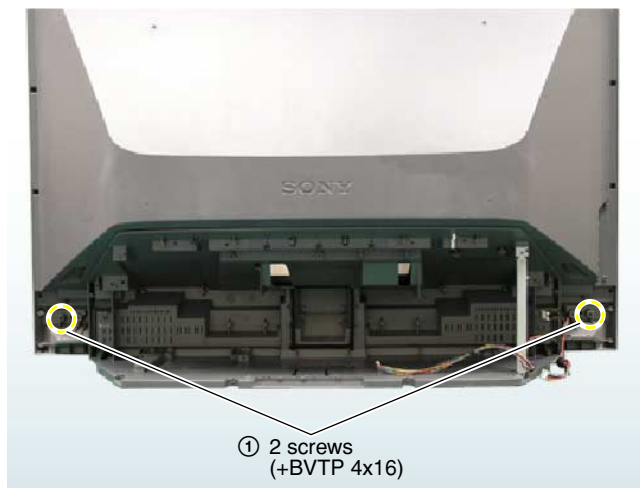

2-20. HA AND HB BOARDS

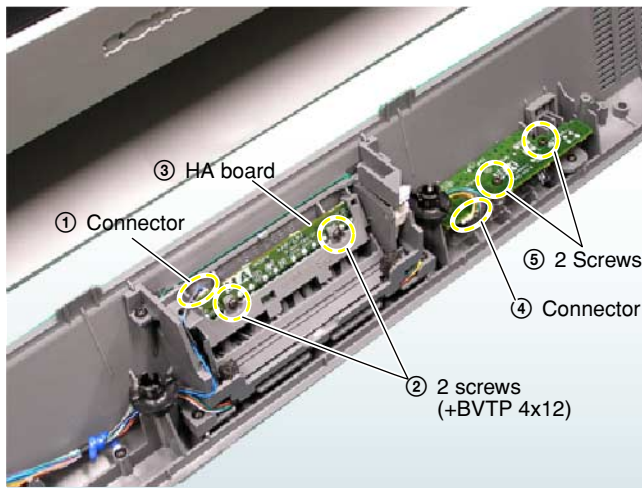

2-21. SCREEN FRAME BLOCK ASSEMBLY

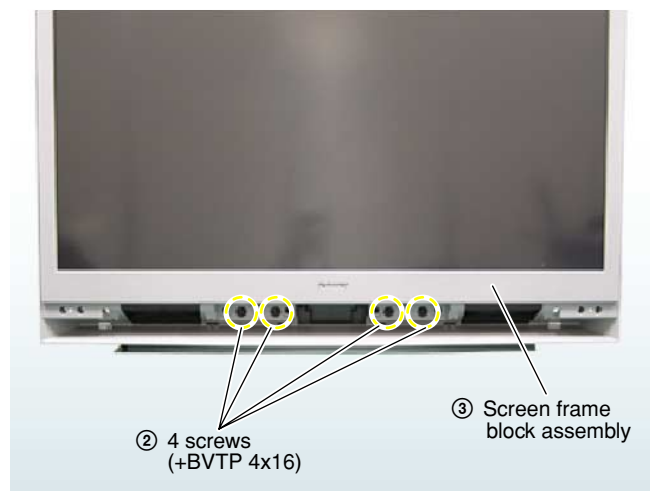
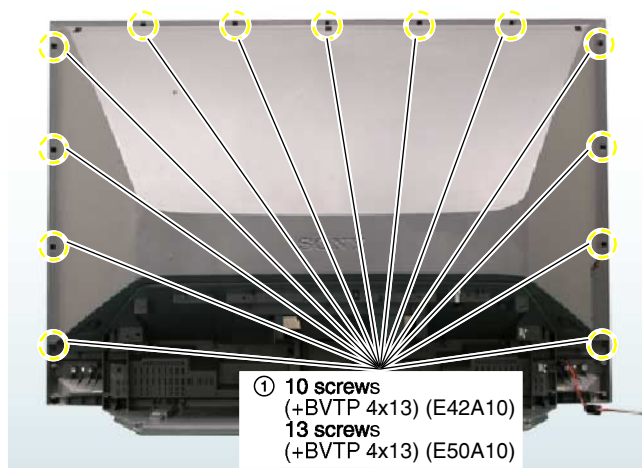

2-22. SPEAKERS

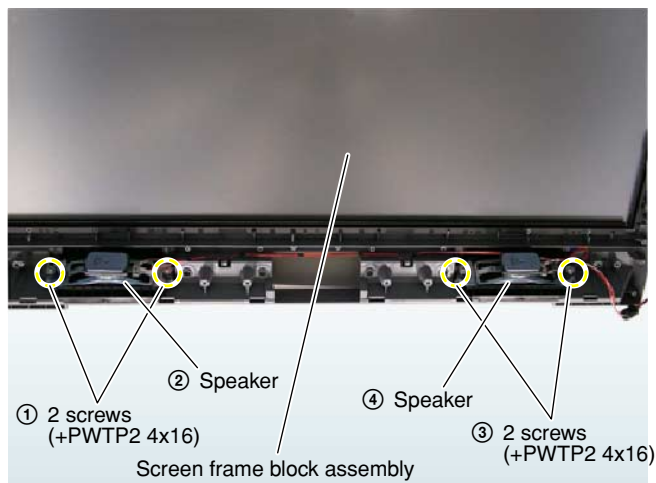

2-23. REAR COVER (WITH MIRROR)

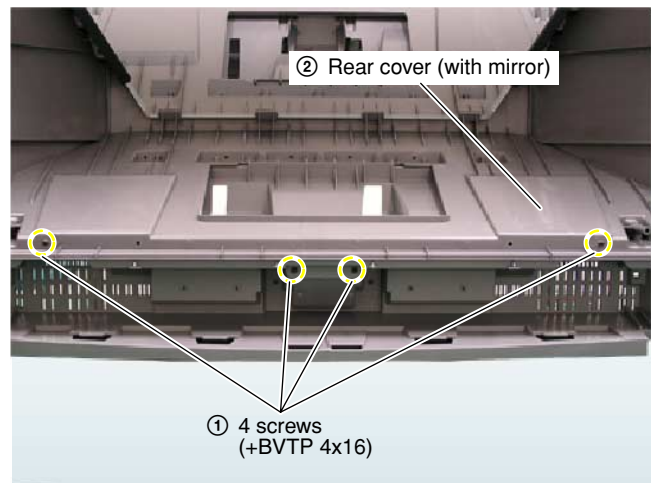

2-24. HOW TO REPLACE OPTICS UNIT

2-24-1. Remove Lamp Block (1)

Remove "Door, Lamp".

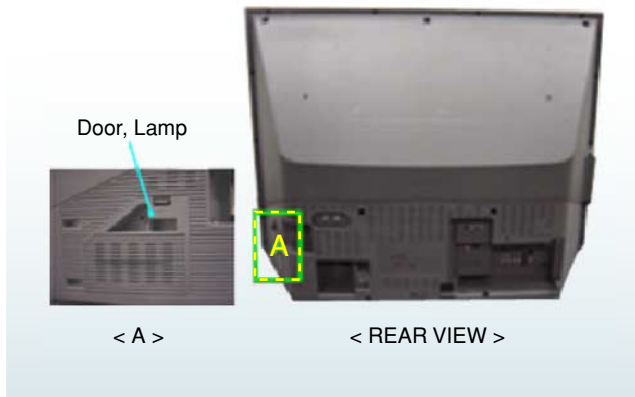

2-24-2. Remove Lamp Block (2)

Turn left "Lever, Lock" below, and then remove "Door, Lamp".

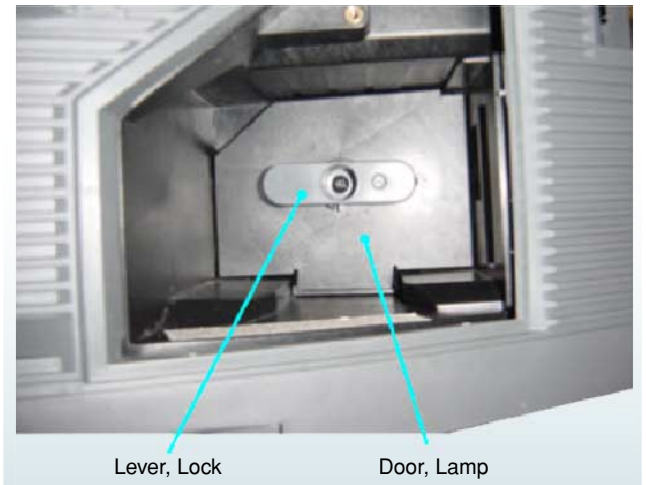

2-24-3. Remove Lamp Block (3)

Pull the "Lever, Lock" below to remove "Lamp block".

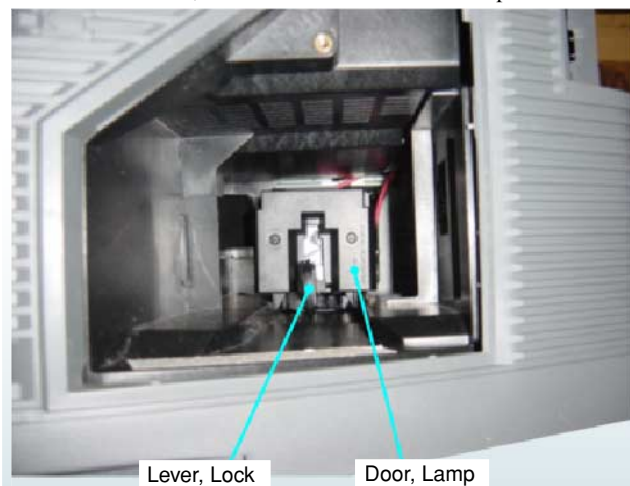

2-24-4. Remove Cover, Rear (1)

Take off 11 screws (42"), and then pull out "Cover, Rear".

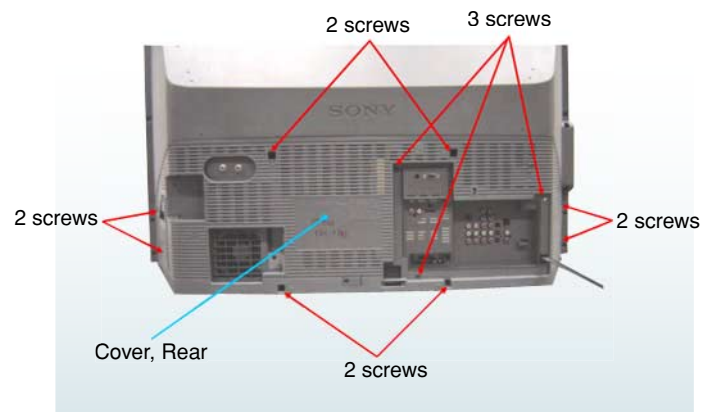

2-24-5. Remove Cover, Rear (1-2)

Take off 13 screws (50").

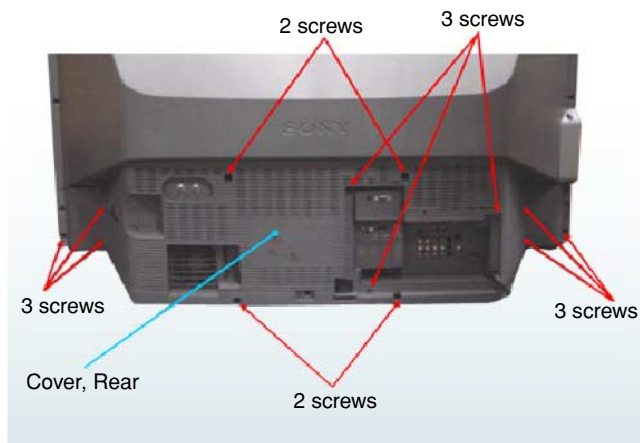

2-24-6. Remove Cover, Rear (2)

It is removed "Cover, Rear".



2-24-7. Remove Stay (L), Side

Take off 4 screws, and then remove 2 "Stay (L), Side".

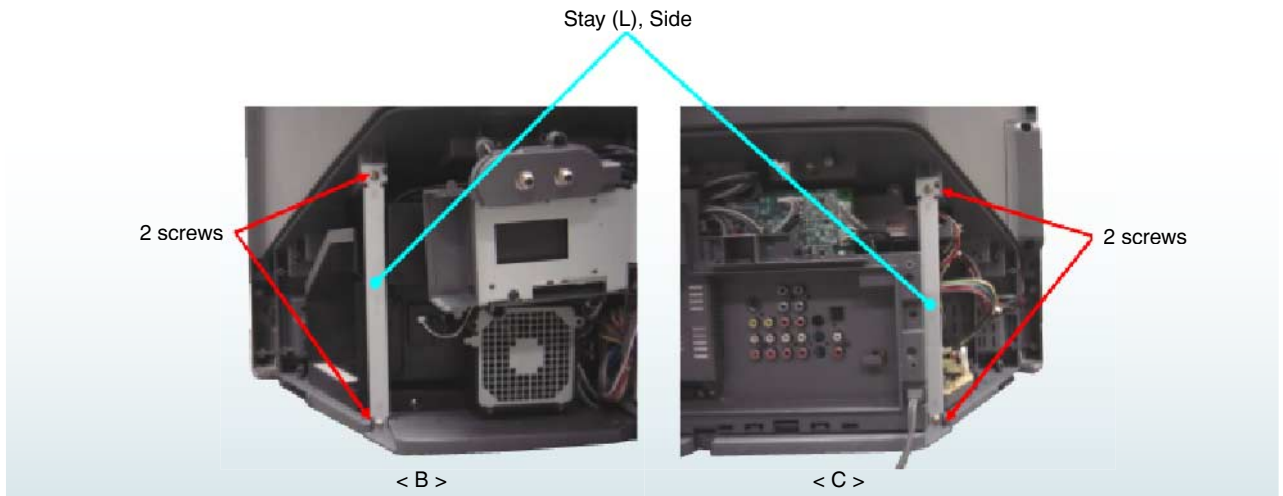

2-24-8. Pull Out Some Blocks (1)

Take off 4 screws.

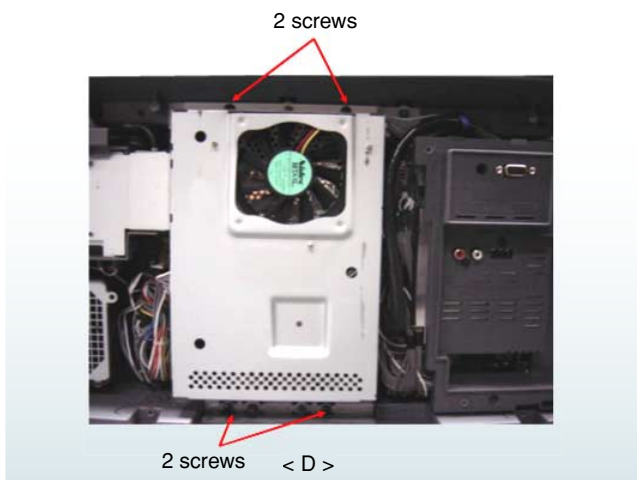

2-24-9. Pull Out Some Blocks (2)

Take off 5 screws.

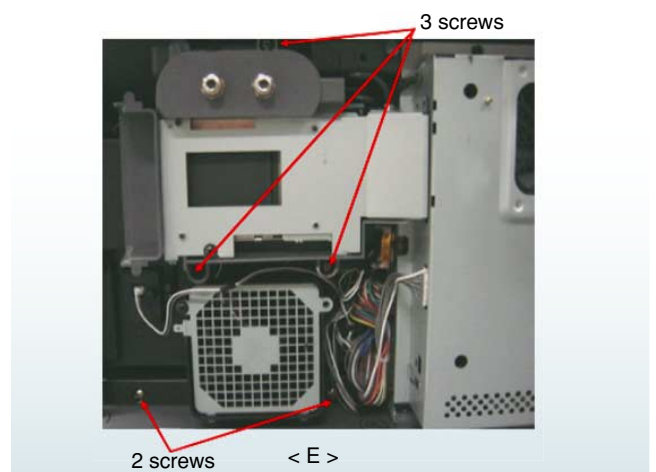

2-24-10. Pull Out Some Blocks (3)

Pull out "B block", "Chassis block", and "Duct (R), Main" a little bit.

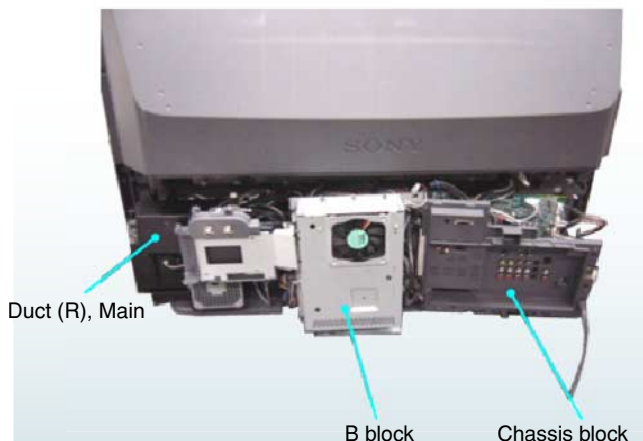

2-24-11. Pull Out Some Blocks (4)

Unlock "Holder, Wire" as shown below.

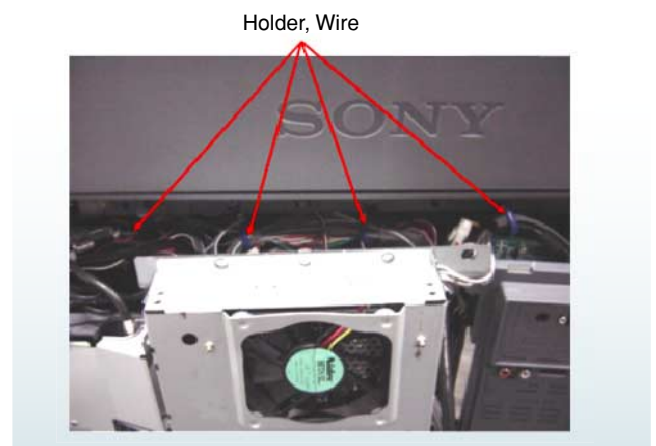

2-24-12. Pull Out Some Blocks (5)

Take off 1 screw.

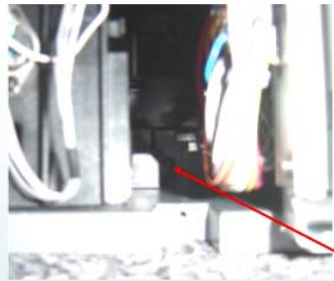

1 screw

< F >

3 screws

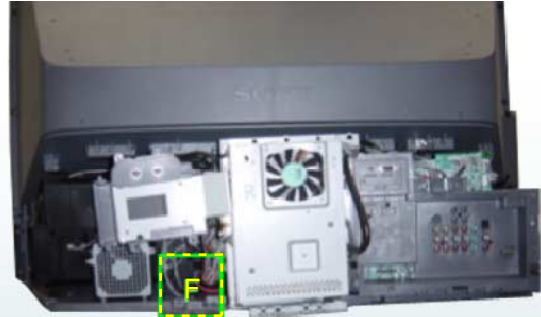

2-24-13. Pull Out Some Blocks (6)

Loose 1 special screw. (This screw can not be taken off.)

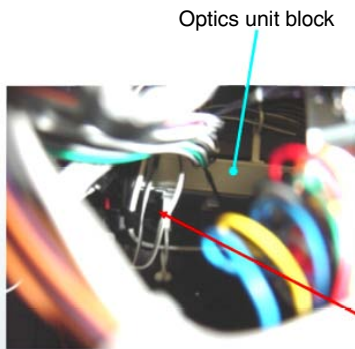

Optics unit block

< G >

1 special screw



2-24-14. Pull Out Some Blocks (7)

Take off 1 screw.

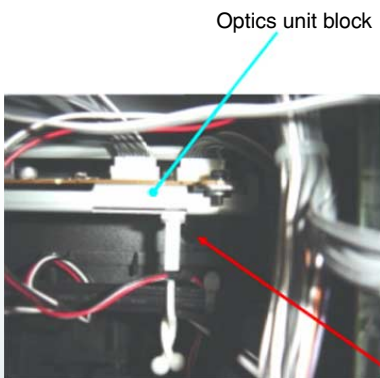

Optics unit block

< H >

1 special screw



2-24-15. Pull Out Some Blocks (8)

Remove 2 connectors to pull out some blocks as shown below.

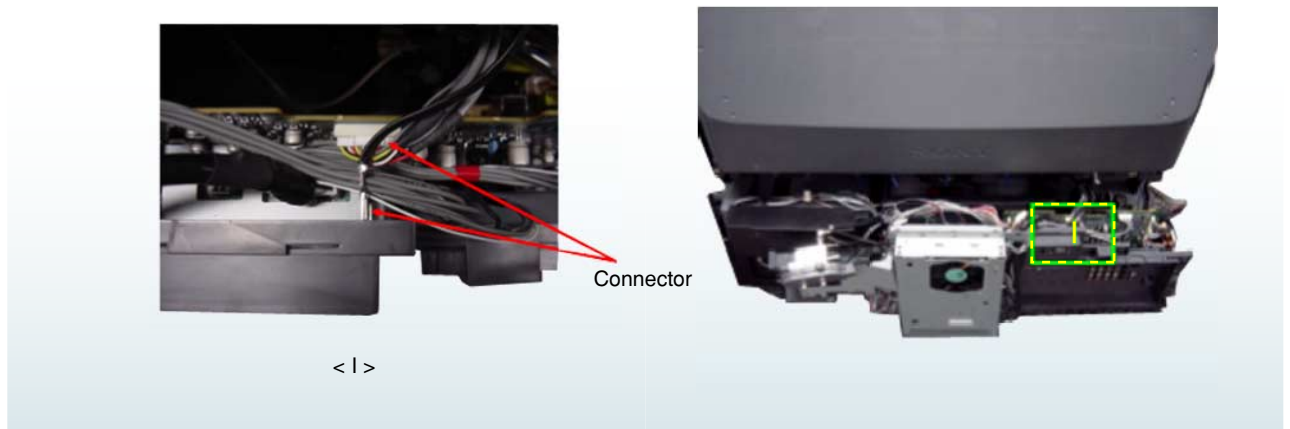

2-24-16. Pull Out Some Blocks (9)

Unlock "Purse Lock" to pull out some blocks as shown below.

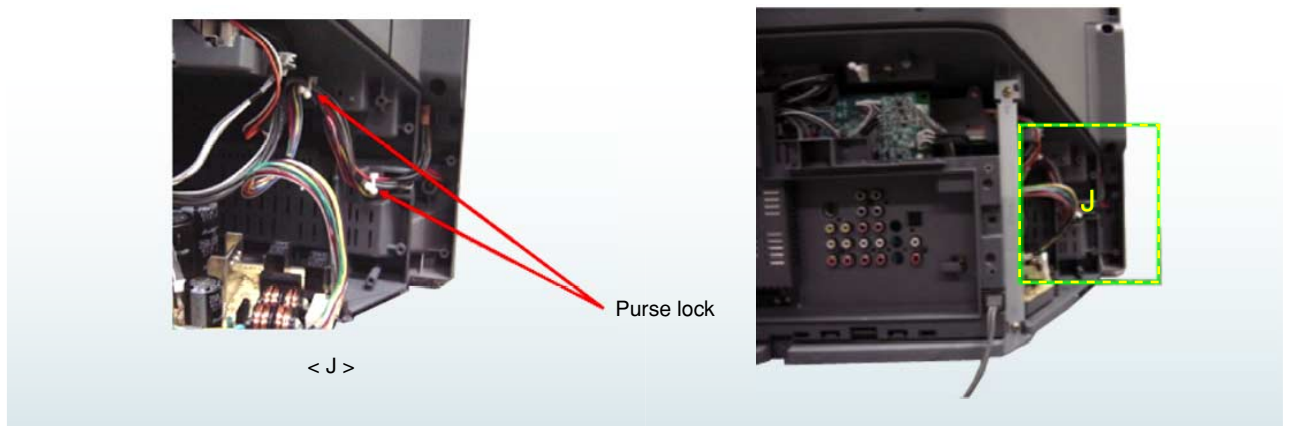

2-24-17. Pull Out Some Blocks (10)

Pull out "B block", "Chassis block", "Duct block", and "Optics Unit block".

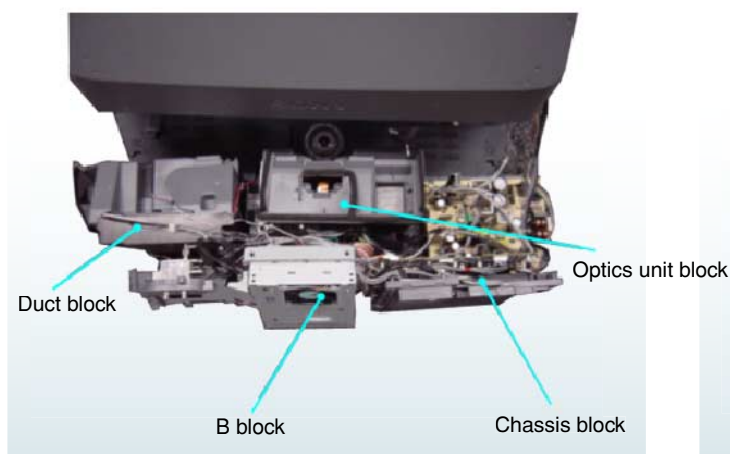

2-24-18. Remove Optics Unit

Remove all connectors to remove "Optics Unit block" and then it.

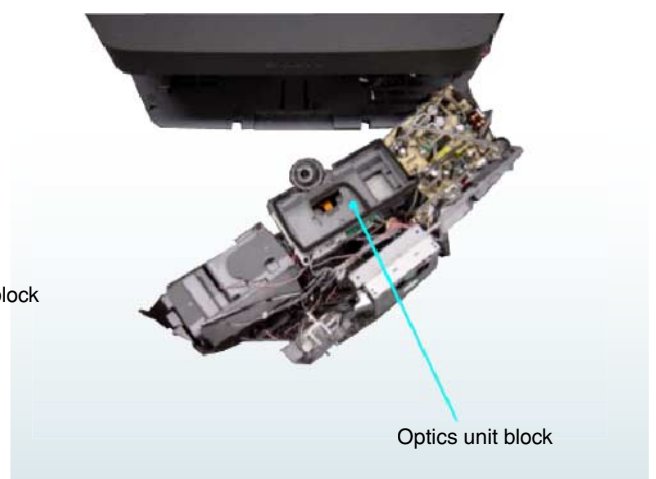

SECTION 3

ELECTRICAL ADJUSTMENTS

3-1. ELECTRICAL ADJUSTMENT BY REMOTE COMMANDER

By using remote commander (RM-YD003), all circuit adjustments can be made.

NOTE : Test Equipment Required.

1. Pattern Generator (with component outputs)
2. Oscilloscope
3. Digital multimeter

3-1-1. Method of Setting the Service Adjustment Mode

1. Standby mode. (Power off)
2. **DISPLAY** → **5** → **VOL (+)** → **TV POWER**
on the remote commander.
(Press each button within a second.)
The following service screen will appear.

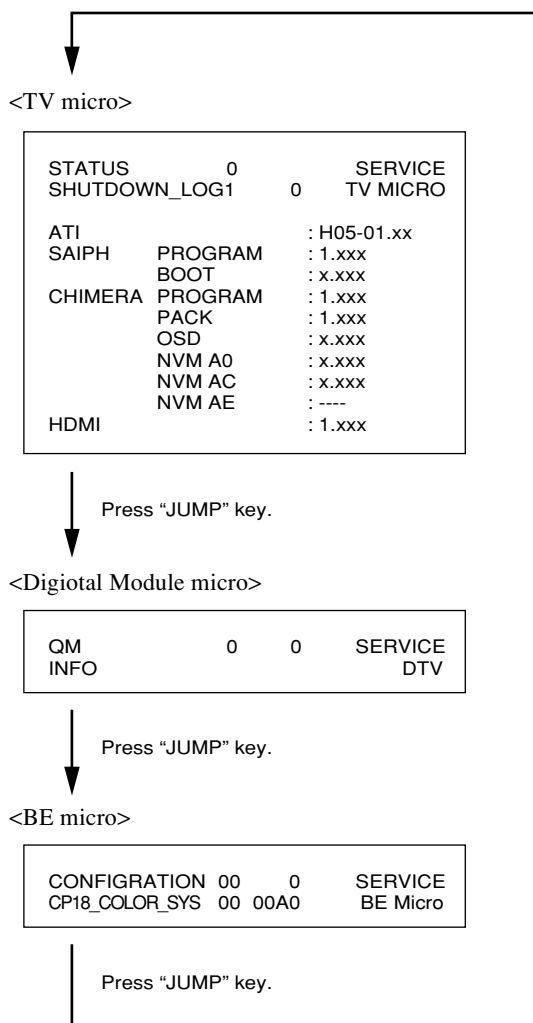

3-1-2. Service Mode Adjustment

1. The SCREEN displays the item being adjusted.
2. Press "①" or "④" on the remote commander to select the adjustment item.
3. Press "③" or "⑥" on the remote commander to change the data.
4. Press "②" or "⑤" on the remote commander to select the category.
Every time you press "②" (Category up).
5. If you want to recover the latest values press "⑩" then "**ENTER**" to read the memory.
6. Press "**MUTING**" then "**ENTER**" to write into memory.
7. Turn power off.

<Method of setting the shipping condition>

1. Service Adjustment mode.
2. Press "⑧" then "**ENTER**"
3. Wait until appearing "Initial Setup" display.
4. Disconnect AC plug and connect again to change factory re-set condition completely.

3-1-3. Memory Write Confirmation Method

1. After adjustment, turn power off with the remote commander.
2. Turn power on and set to service mode.
3. Call the adjusted items again and confirm they were adjusted.

3-1-4. Adjusting Buttons and Indicator

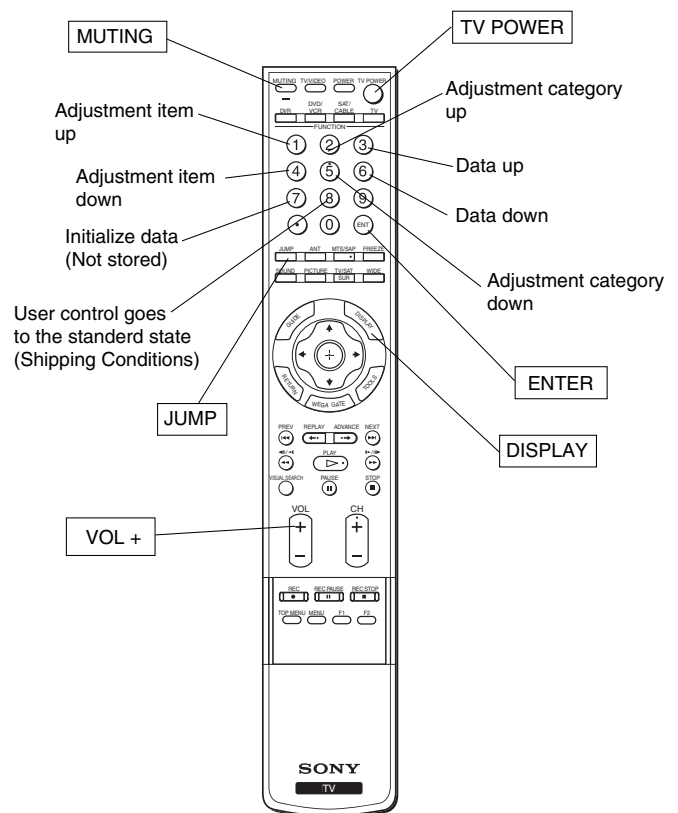

RM-YD003

FUNCTION OF KEYS ON COMMANDER

- ① : Changes adjustment item. (item No. moves up)
- ④ : Changes adjustment item. (item No. moves down)
- ② : Changes adjustment category.
(category moves up)
- ⑤ : Changes adjustment category.
(category moves down)
- ③ : Changes data value. (up)
- ⑥ : Changes data value. (down)

Commander Function

Button	Mode	Description
[MUTING] + [ENTER]	WRITE	Writes data to NVM.
① + [ENTER]	READ	Reads data from NVM.
⑧ + [ENTER]	RESET	Set the shipping condition.

3-2. H/V Center Confirmation and Adjustment

Please check the picture horizontal/vertical center after the replacement of the following parts .

- Optical block
- Top assembly

- 1, Check H/V center with 480i monoscope signal in “Full “ mode .
- 2, If the center is shifted , adjust it with the following service items .

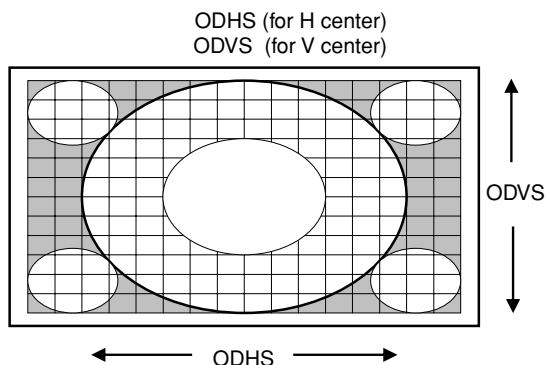

3-3. IRIS Adjustment

Please check it after the replacement of the following parts.

- IRIS unit+Optics unit block+C board
- B board

Check values of the service data in NVM on C board

DBL_CTRL_AC	#0	BL_U_TOP
	#1	BL_U_BOTTOM
	#2	BL_MAX
	#3	BL_MIN
	#4	IRIS_GAIN
	#5	HALL_GAIN

and write the same values on C board to the service data in NVM on B board.

DBL_CTRL	#0	BL_U_TOP
	#1	BL_U_BOTTOM
	#2	BL_MAX
	#3	BL_MIN
	#4	IRIS_GAIN
	#5	HALL_GAIN

SECTION 4
DIAGRAMS

4-1. BLOCK DIAGRAM (1)

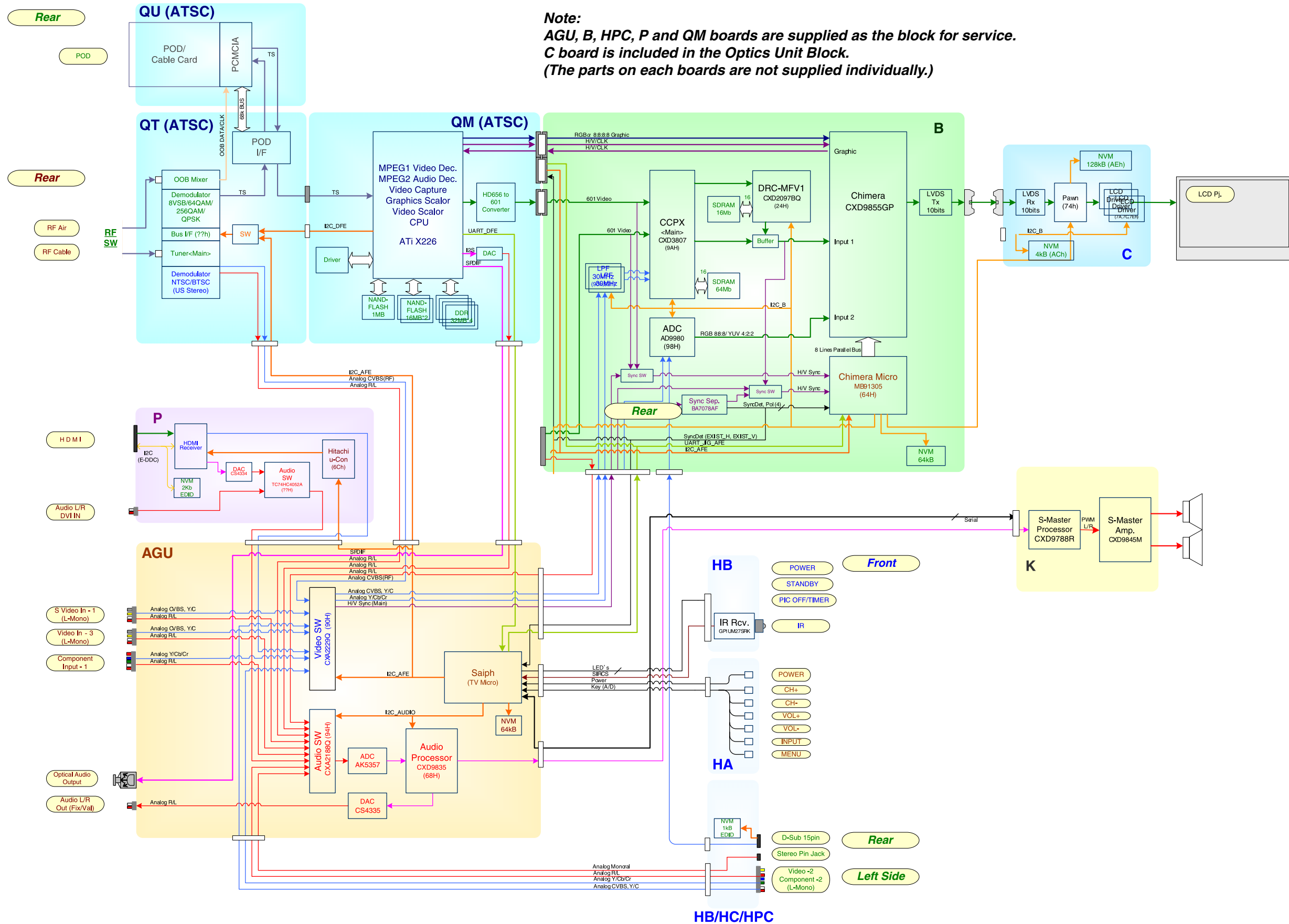

Note:
AGU, B, HPC, P and QM boards are supplied as the block for service.
C board is included in the Optics Unit Block.
(The parts on each boards are not supplied individually.)

BLOCK DIAGRAM (2)

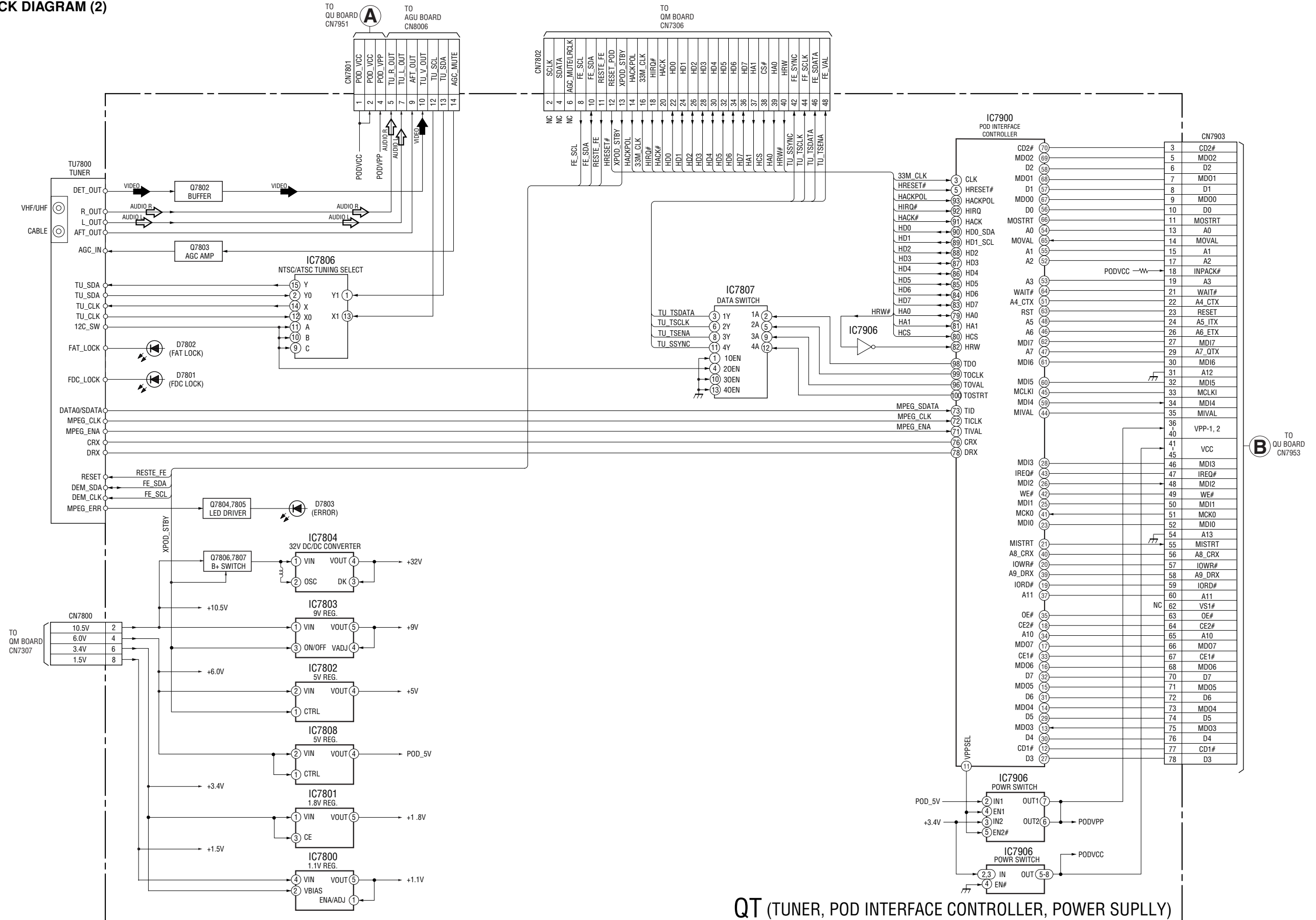

BLOCK DIAGRAM (3)

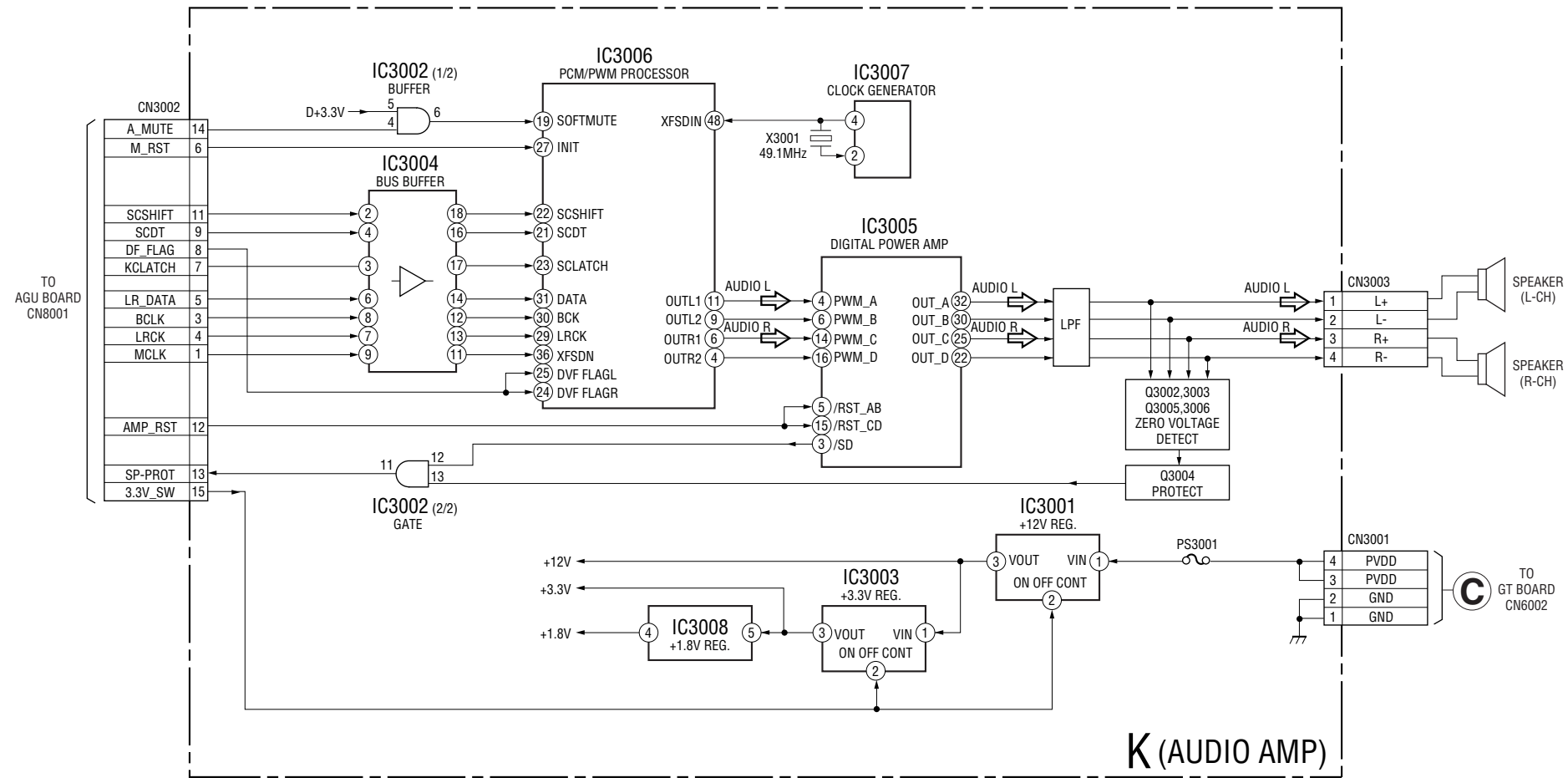

BLOCK DIAGRAM (4)

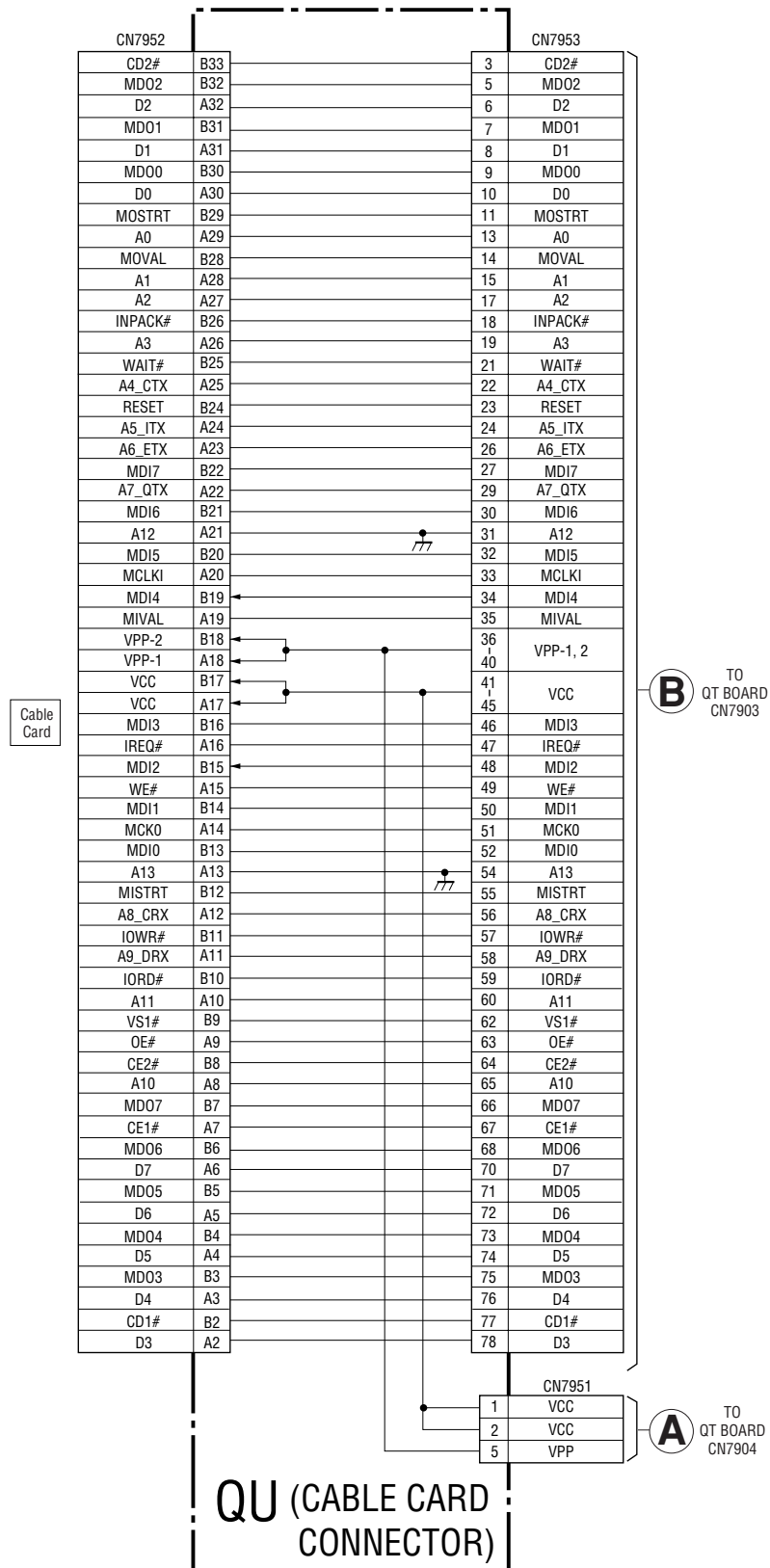

BLOCK DIAGRAM (5)

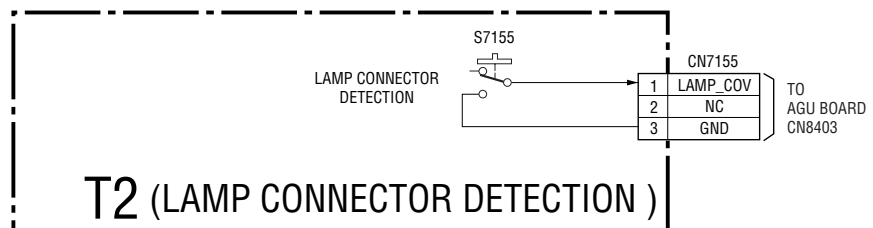
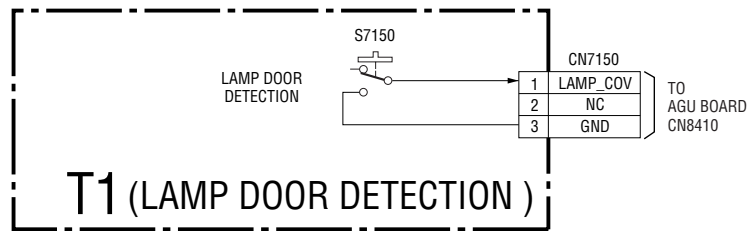
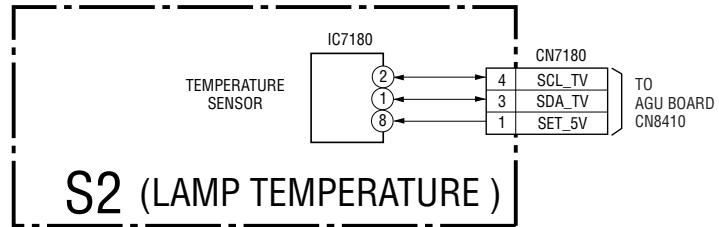

BLOCK DIAGRAM (6)

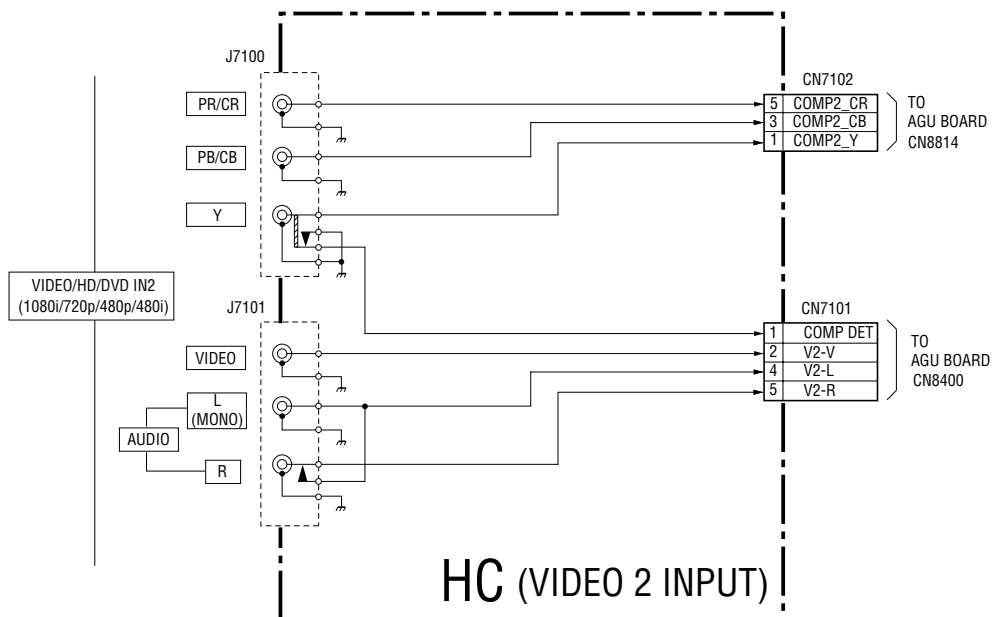
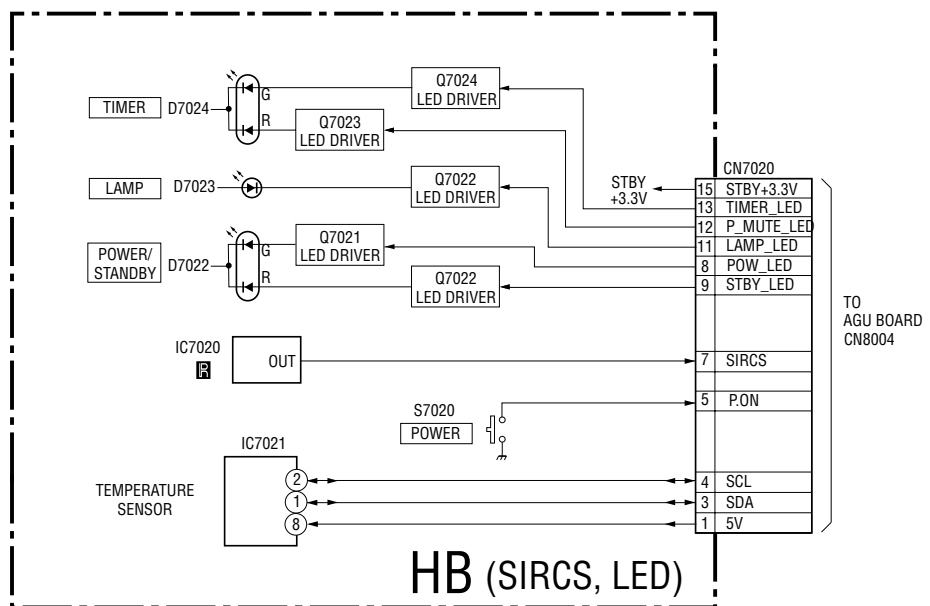
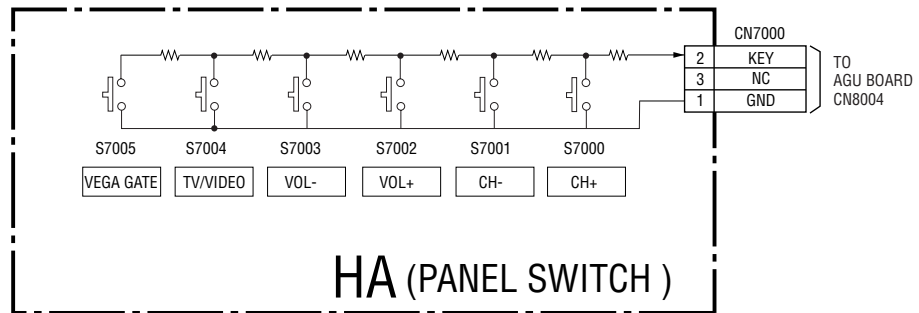

BLOCK DIAGRAM (7)

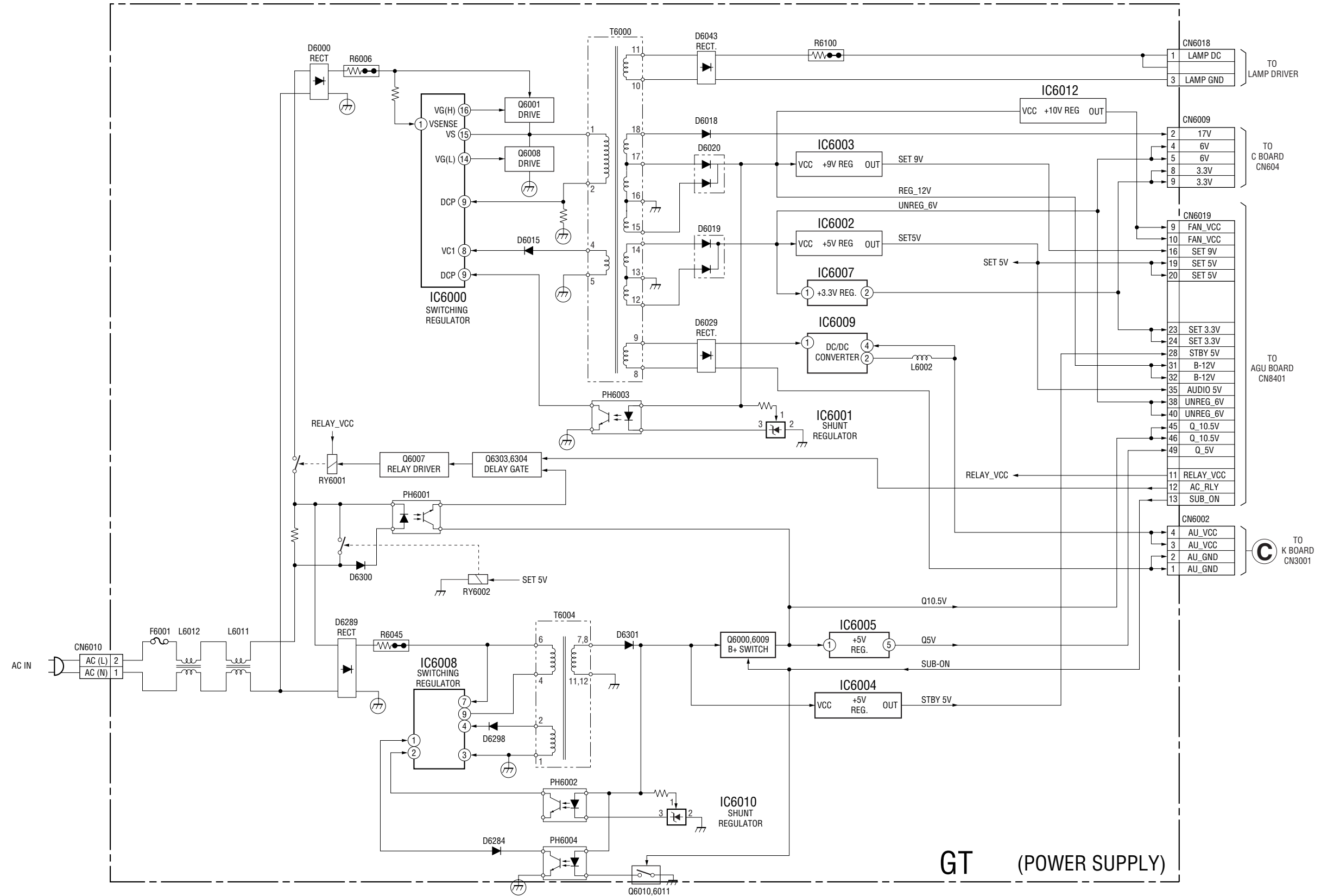

4-2. FRAME SCHEMATIC DIAGRAM

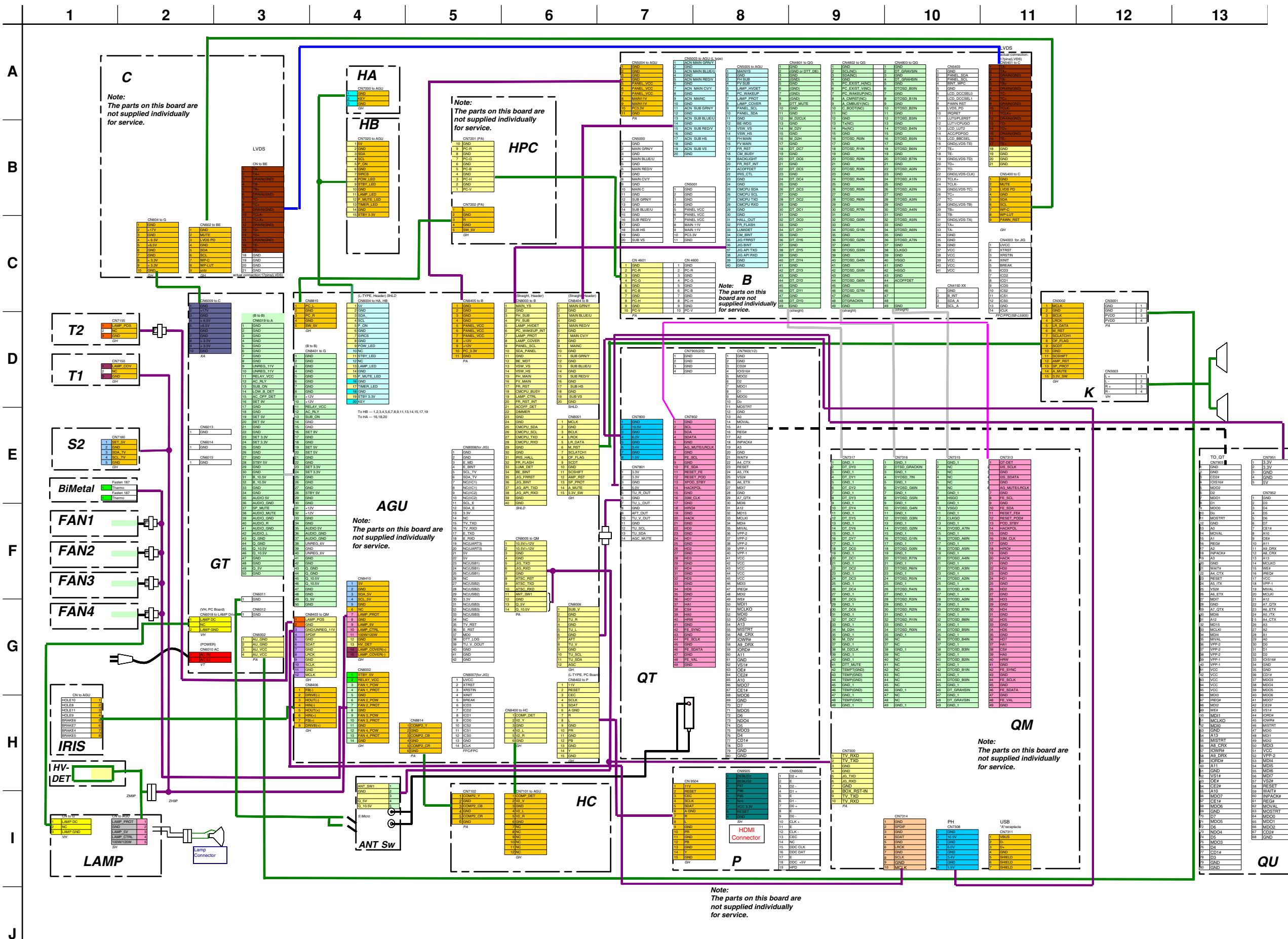

4-3. CIRCUIT BOARDS LOCATION

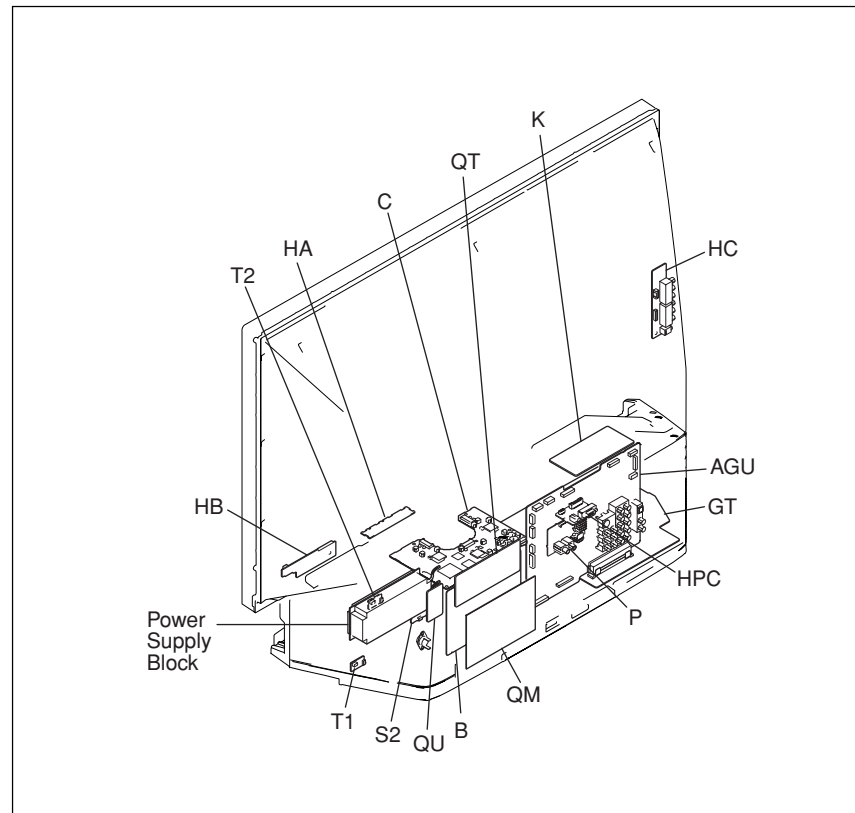

4-4. SCHEMATIC DIAGRAMS

Note:

- The parts marked “#” on schematic diagrams are not mounted.
- All capacitors are in μF unless otherwise noted. (pF: μpF) Capacitors without voltage indication are all 50 V.
- Indication of resistance, which does not have one for rating electrical power, is as follows.

Pitch: 5 mm
Rating electrical power 1/4 W (CHIP : 1/10 W)

- All resistors are in ohms.
- : nonflammable resistor.
- : fusible resistor.
- Δ : internal component.
- : panel designation, and adjustment for repair.
- All variable and adjustable resistors have characteristic curve B, unless otherwise noted.
- \perp : earth-ground.
- : earth-chassis.
- All voltages are in V.
- Readings are taken with a 10 M Ω digital multimeter.
- Readings are taken with a color-bar signal input.
- Voltage variations may be noted due to normal production tolerances.
- * : Can not be measured.
- Circled numbers are waveform references.
- : B + bus.
- : B - bus.
- : Signal path.

Reference information

RESISTOR	: RN	METAL FILM
	: RC	SOLID
	: FPRD	NONFLAMMABLE CARBON
	: FUSE	NONFLAMMABLE FUSIBLE
	: RW	NONFLAMMABLE WIREWOUND
	: RS	NONFLAMMABLE METAL OXIDE
	: RB	NONFLAMMABLE CEMENT
COIL	: LF-8L	MICRO INDUCTOR
CAPACITOR	: TA	TANTALUM
	: PS	STYROL
	: PP	POLYPROPYLENE
	: PT	MYLAR
	: MPS	METALIZED POLYESTER
	: MPP	METALIZED POLYPROPYLENE
	: ALB	BIPOLAR
	: ALT	HIGH TEMPERATURE
	: ALR	HIGH RIPPLE

Note: The components identified by shading and mark Δ are critical for safety. Replace only with part number specified.

Terminal name of semiconductors in silk screen printed circuit (*)

Device	Printed symbol	Terminal name	Circuit
① Transistor		Collector Base Emitter	
② Transistor		Collector Base Emitter	
③ Diode		Cathode Anode	
④ Diode		Cathode Anode (NC)	
⑤ Diode		Cathode Anode (NC)	
⑥ Diode		Common Anode Cathode	
⑦ Diode		Common Anode Cathode	
⑧ Diode		Common Anode Anode	
⑨ Diode		Common Anode Anode	
⑩ Diode		Common Cathode Cathode	
⑪ Diode		Common Cathode Cathode	
⑫ Diode		Anode Anode Cathode Anode	
⑬ Transistor (FET)		Drain Source Gate	
⑭ Transistor (FET)		Drain Source Gate	
⑮ Transistor (FET)		Source Drain Gate	
⑯ Transistor		Emitter Collector Base	
⑰ Transistor		C2 B1 E1 E2 B2 C1	
⑱ Transistor		C1 B2 E2 E1 B1 C2	
⑲ Transistor		C1 B2 E2 E1 B1 C2	
⑳ Transistor		C1 B2 E2 E1 B1 C2	
㉑ Transistor		E2 B1 E1 C2 C1(B2)	
㉒ Transistor		(B2) B1 E1 E2 C1 C2	
㉓ Transistor		(B2) E2 E1 B1 C2 C1	
-	Discrete semiconductor		

(Chip semiconductors that are not actually used are included.)

Ver.1.5

(1) Schematic Diagram of GT Board

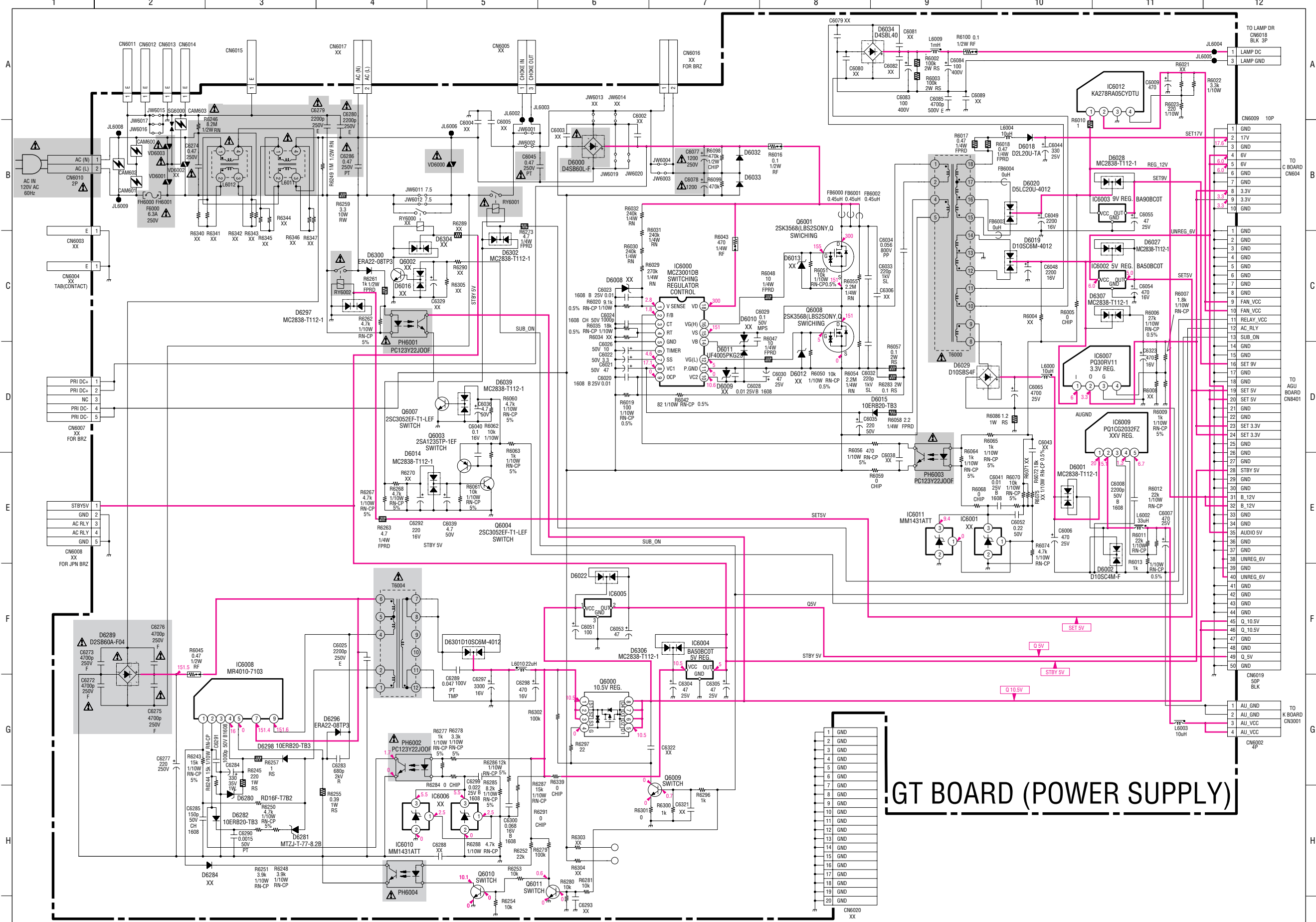

GT BOARD (POWER SUPPLY)

(2) Schematic Diagram of HA Board

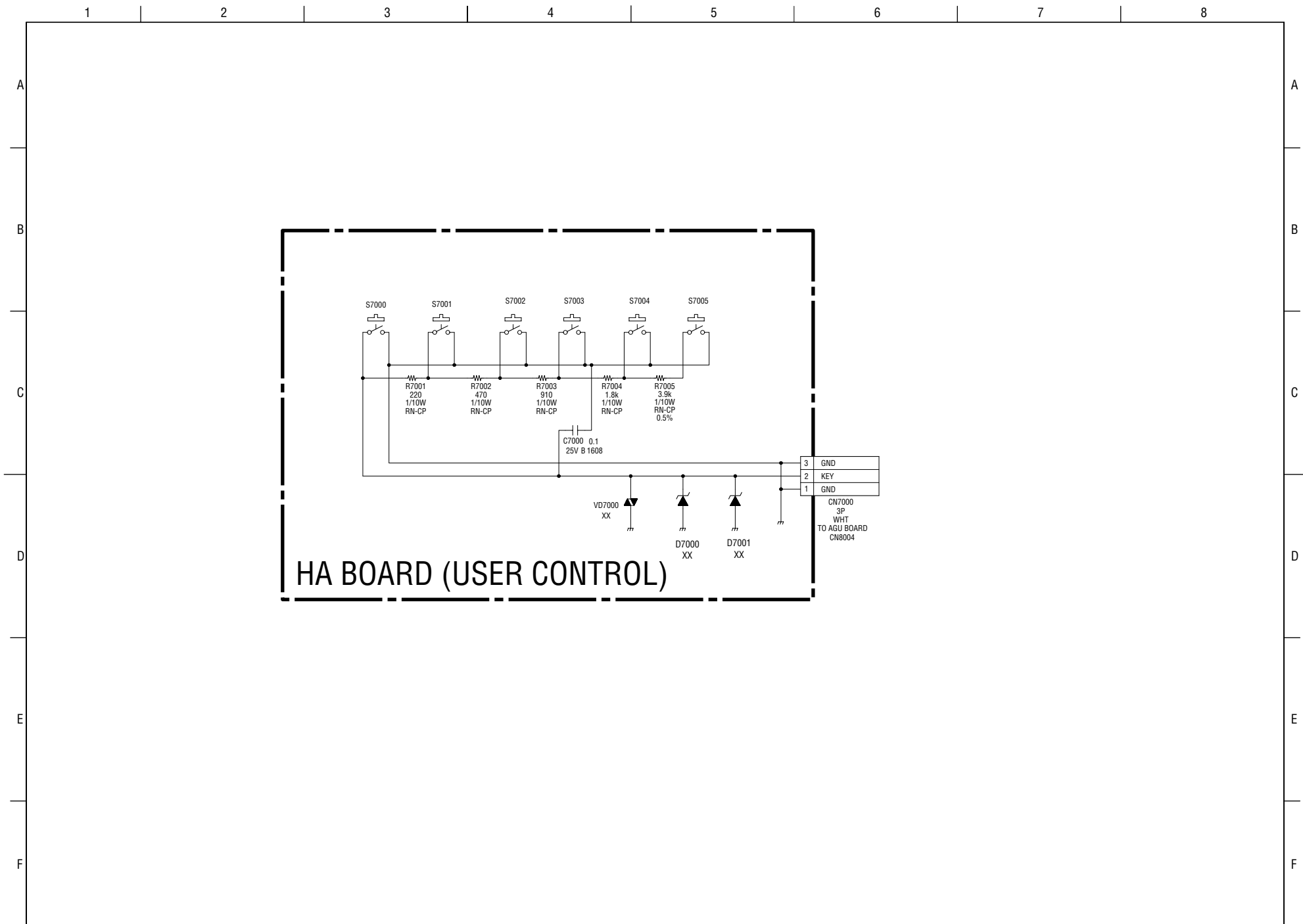

(3) Schematic Diagram of HB Board

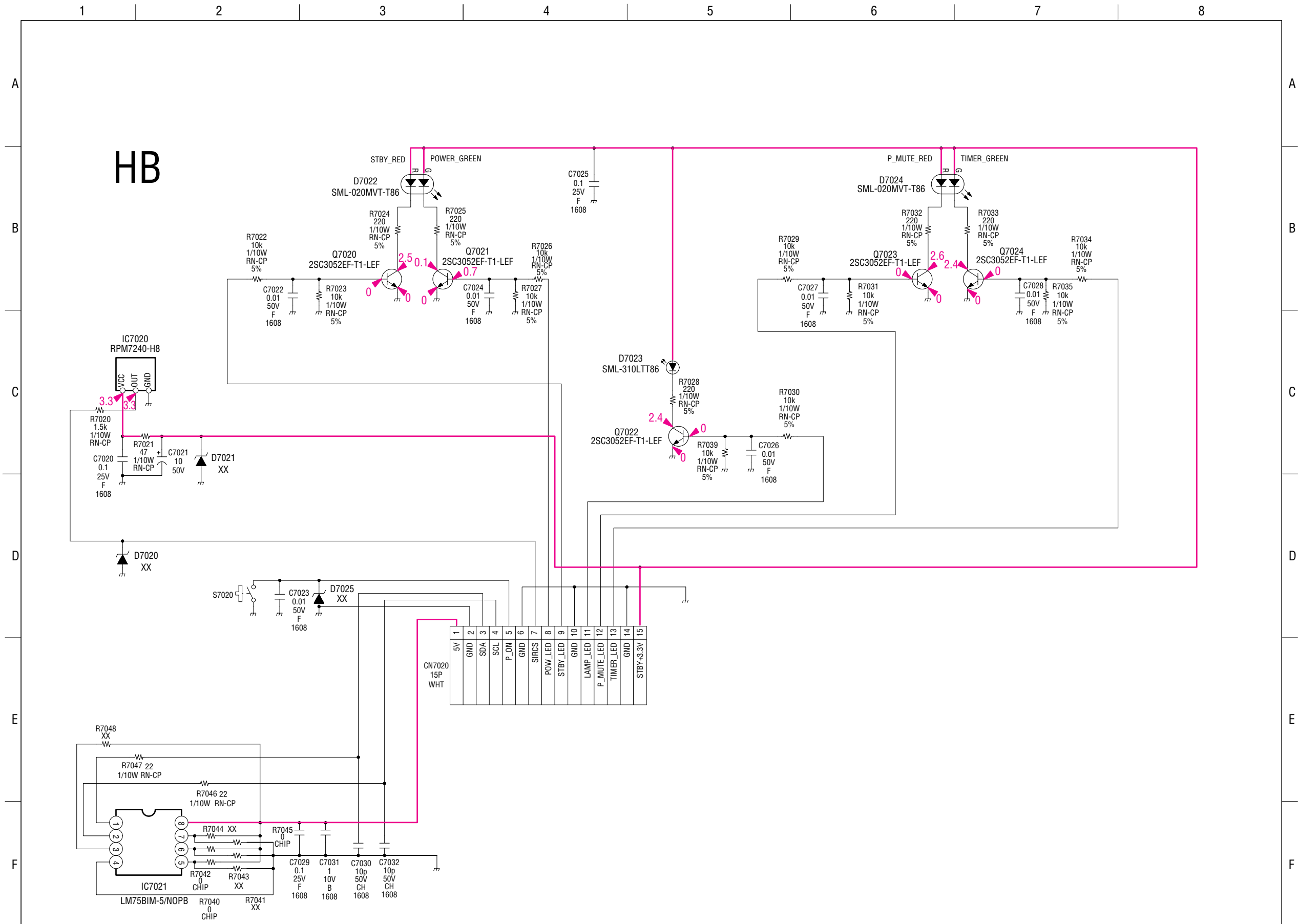

(4) Schematic Diagram of HC Board

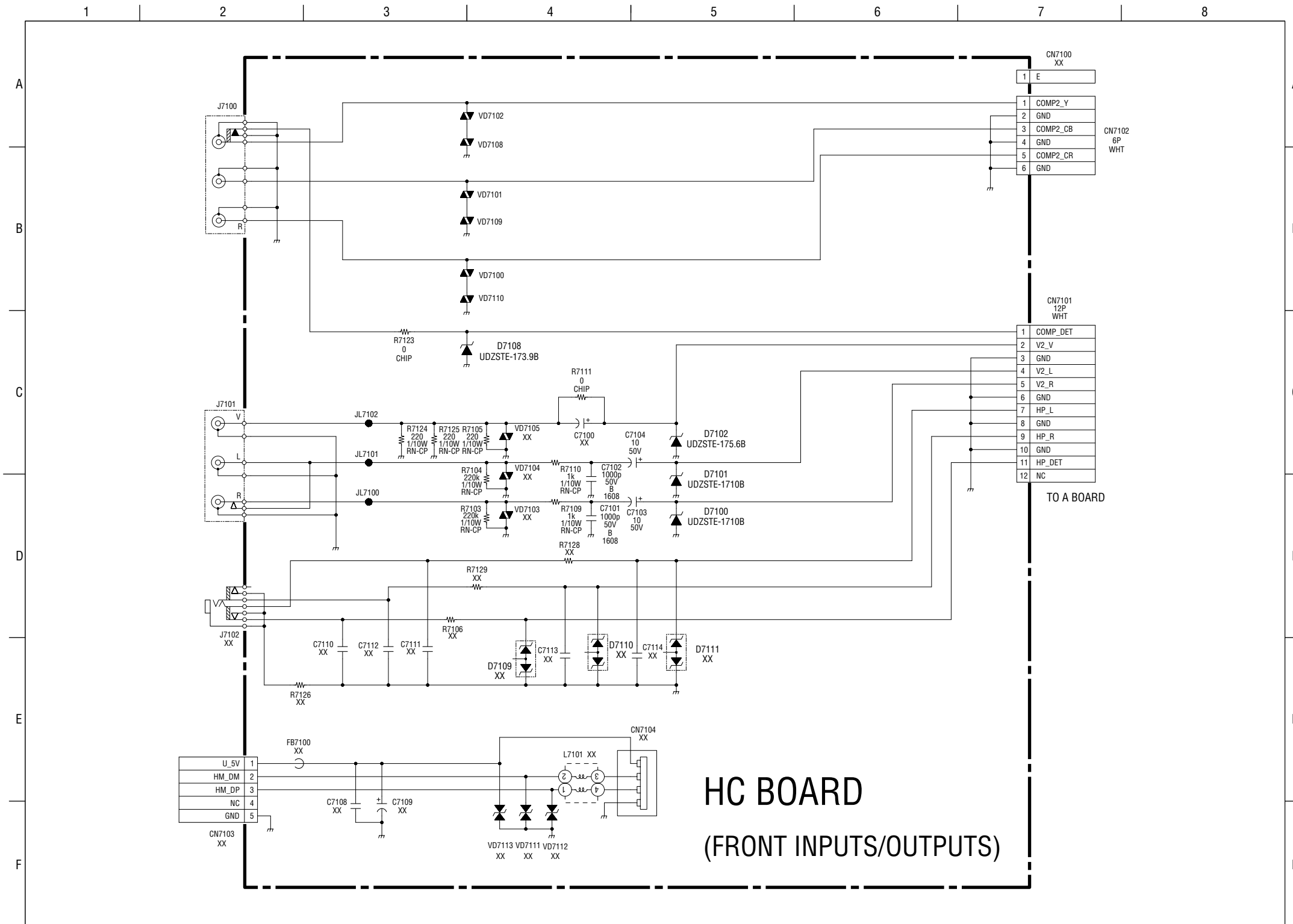

(5) Schematic Diagram of K Board

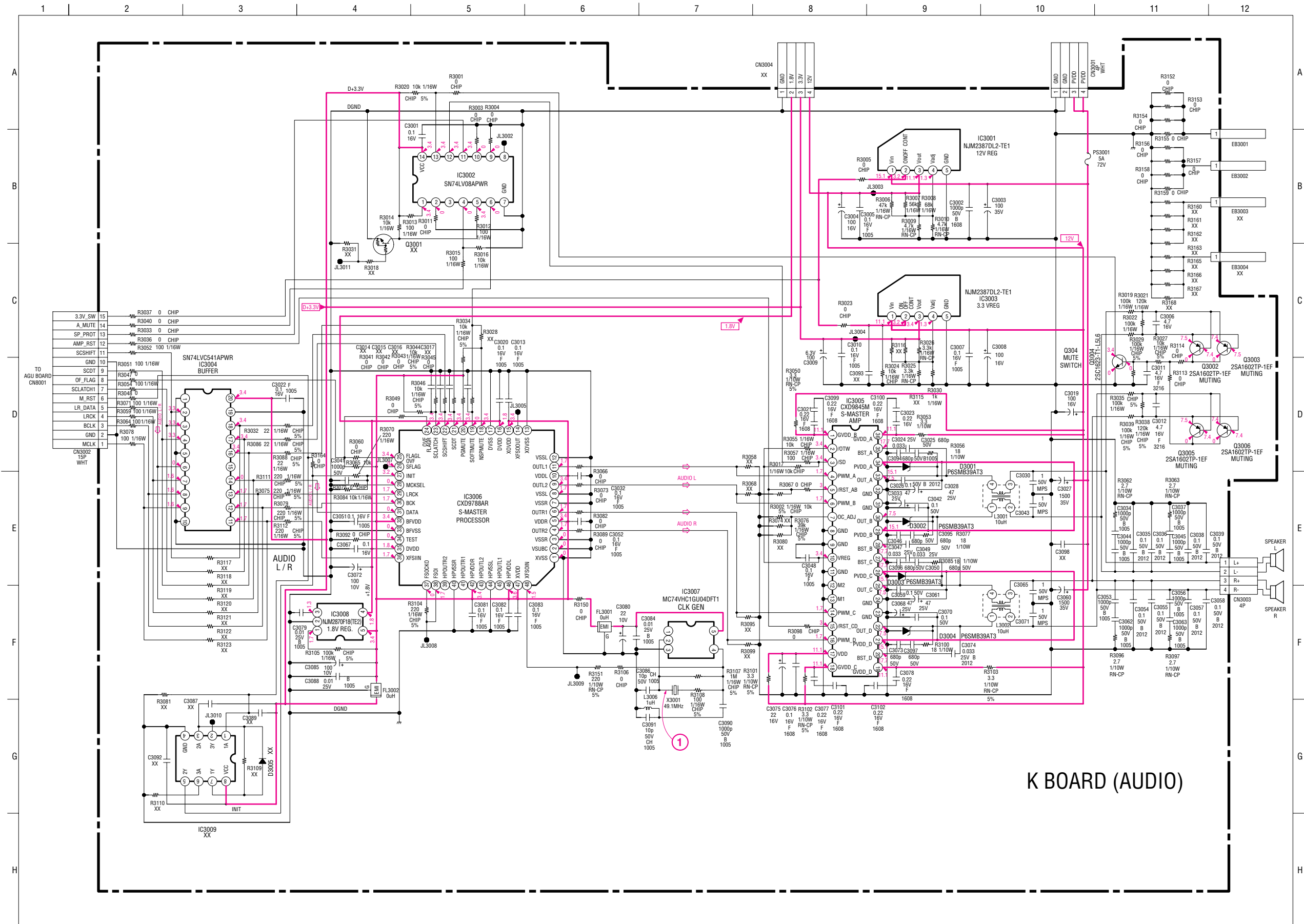

K BOARD (AUDIO)

(6) Schematic Diagram of QT (1/3) Board

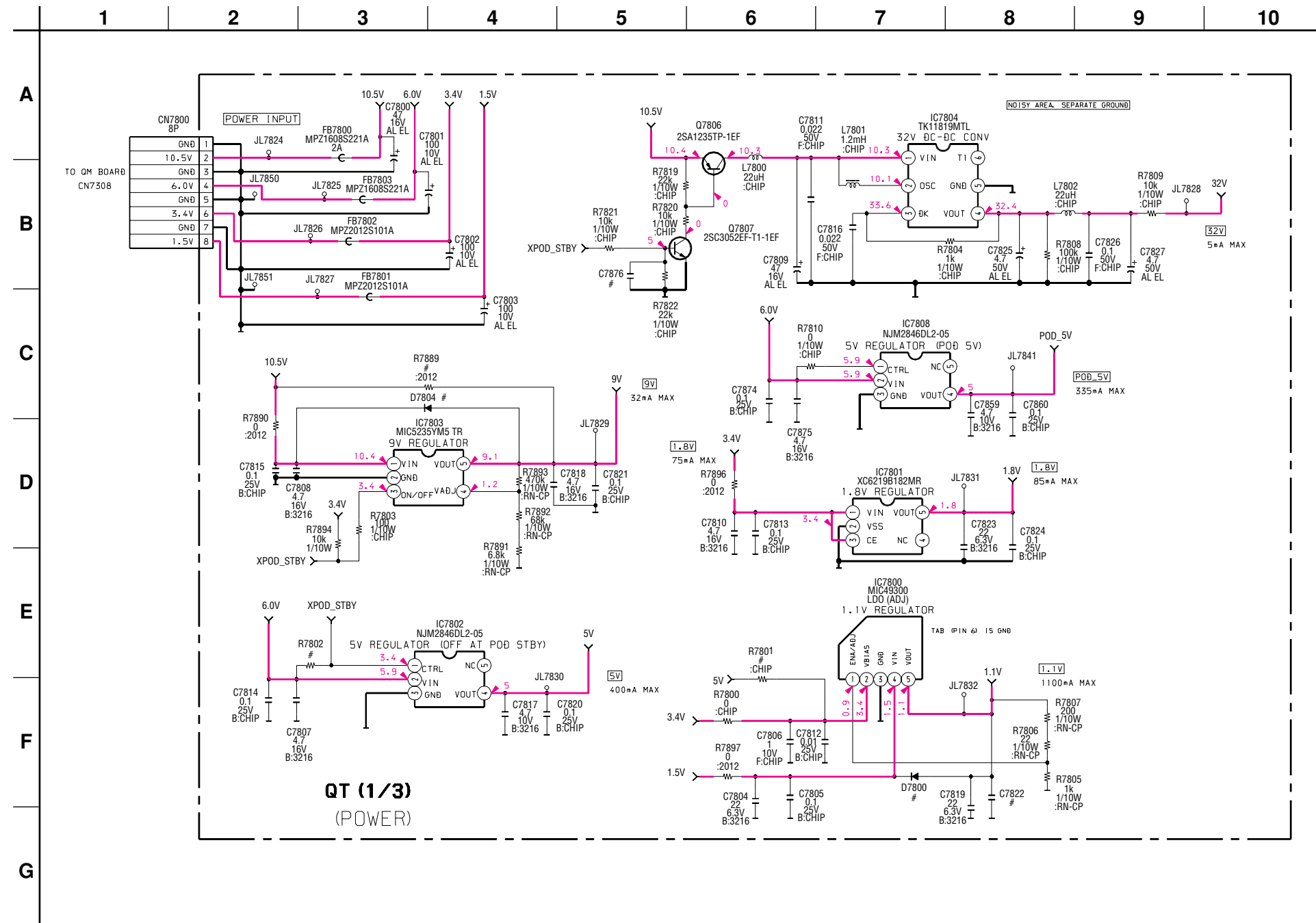

(7) Schematic Diagram of QT (2/3) Board

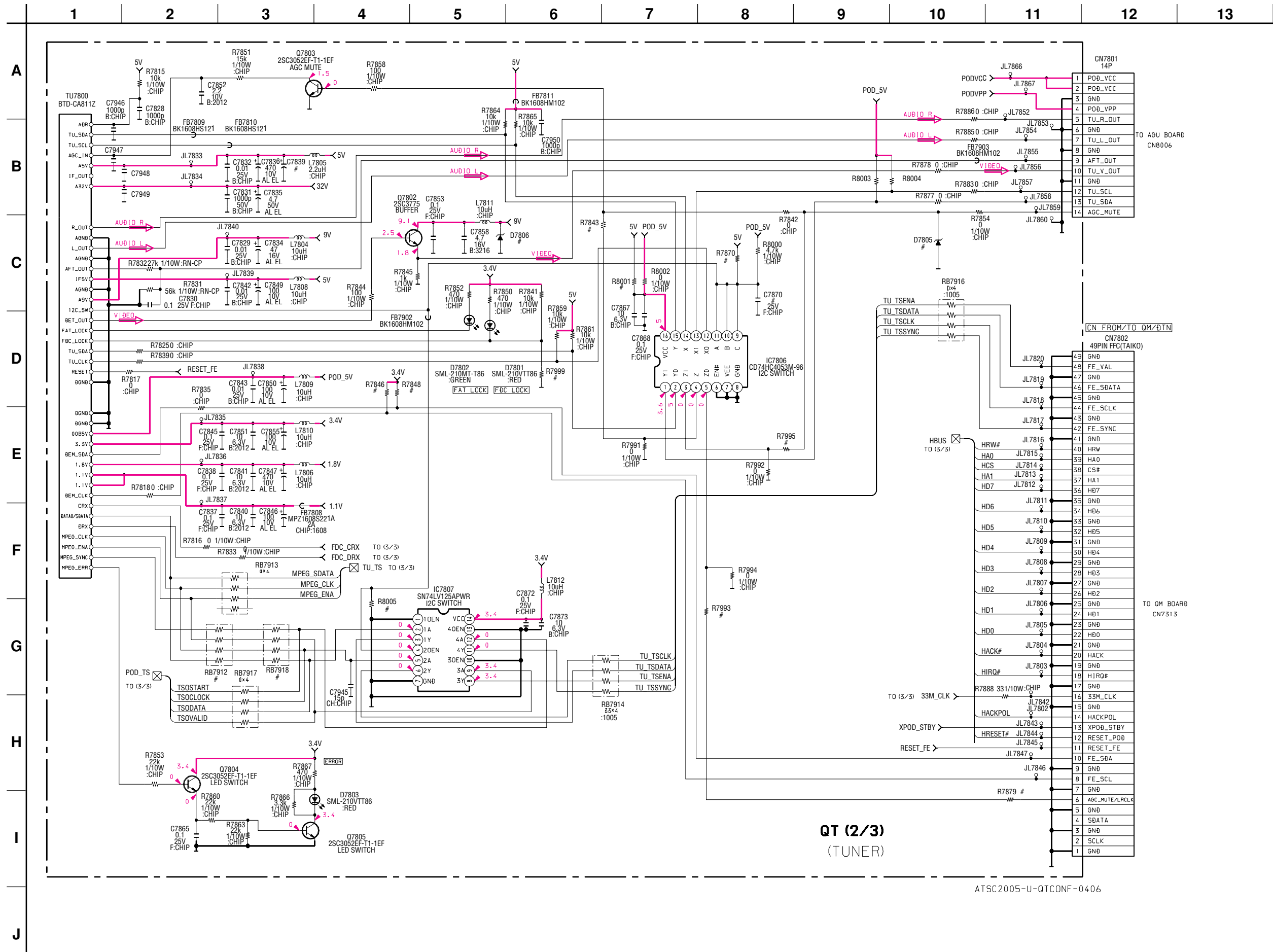

(8) Schematic Diagram of QT (3/3) Board

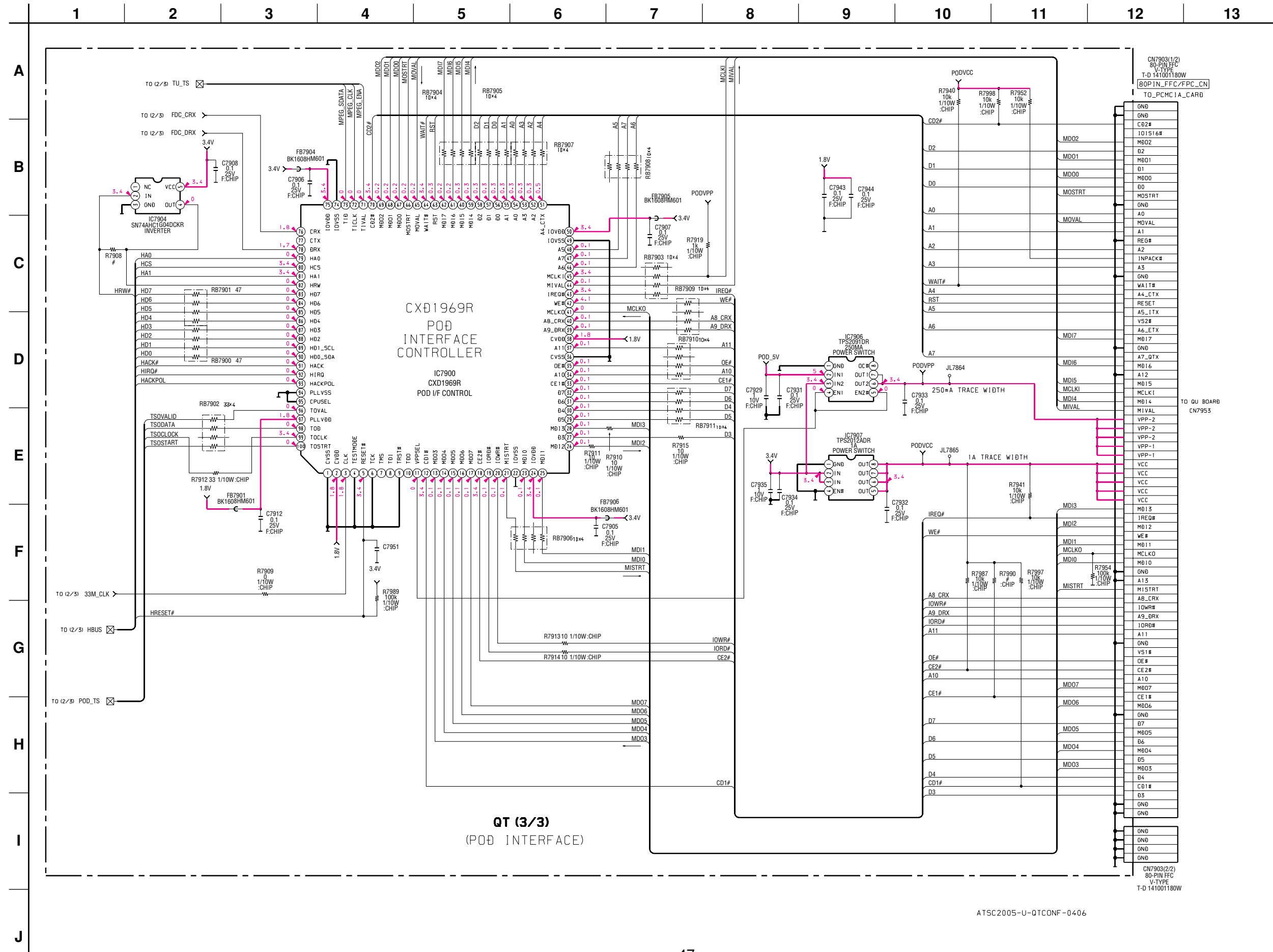

(9) Schematic Diagram of QU Board

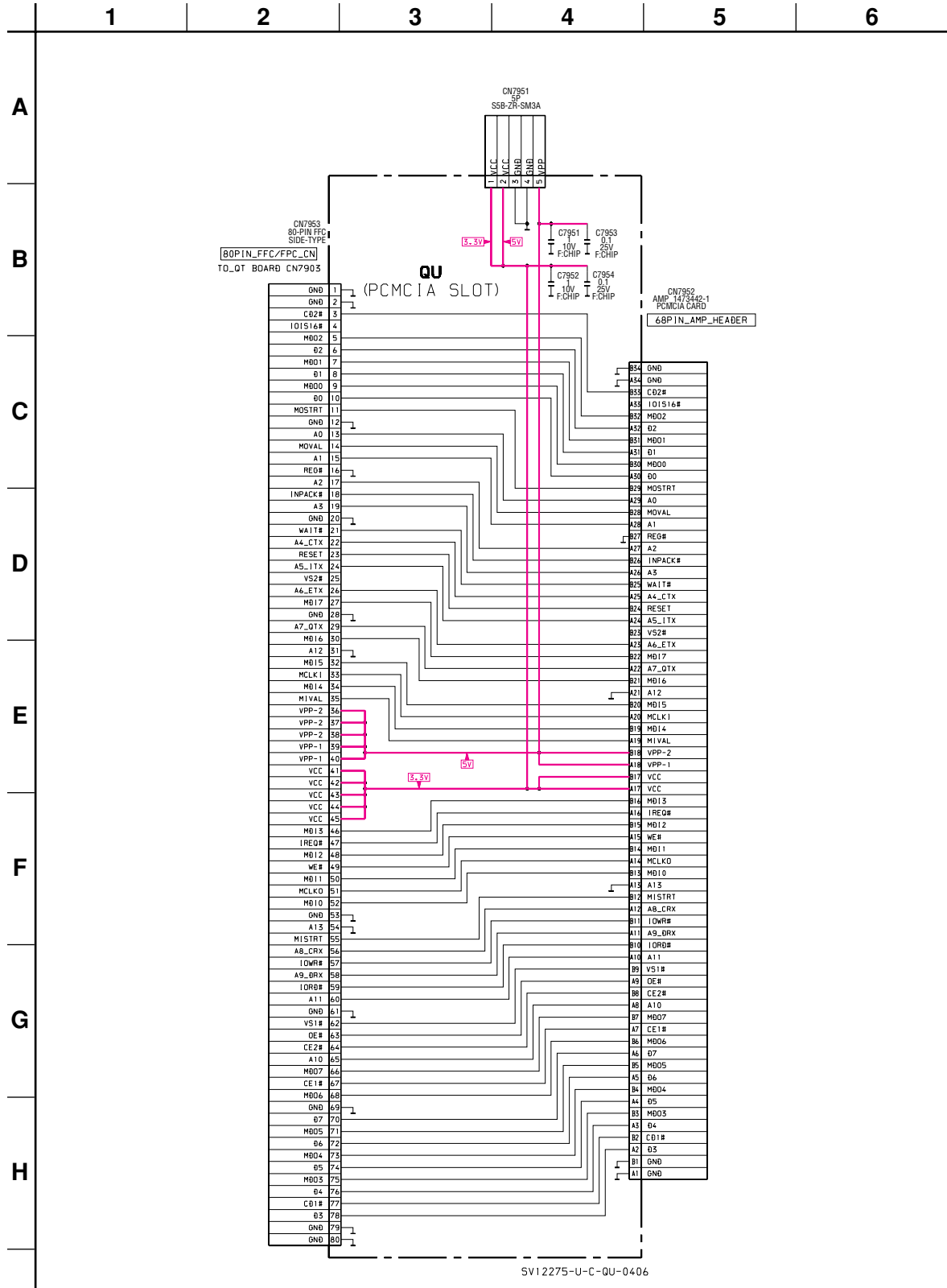

(10) Schematic Diagram of S2 Board

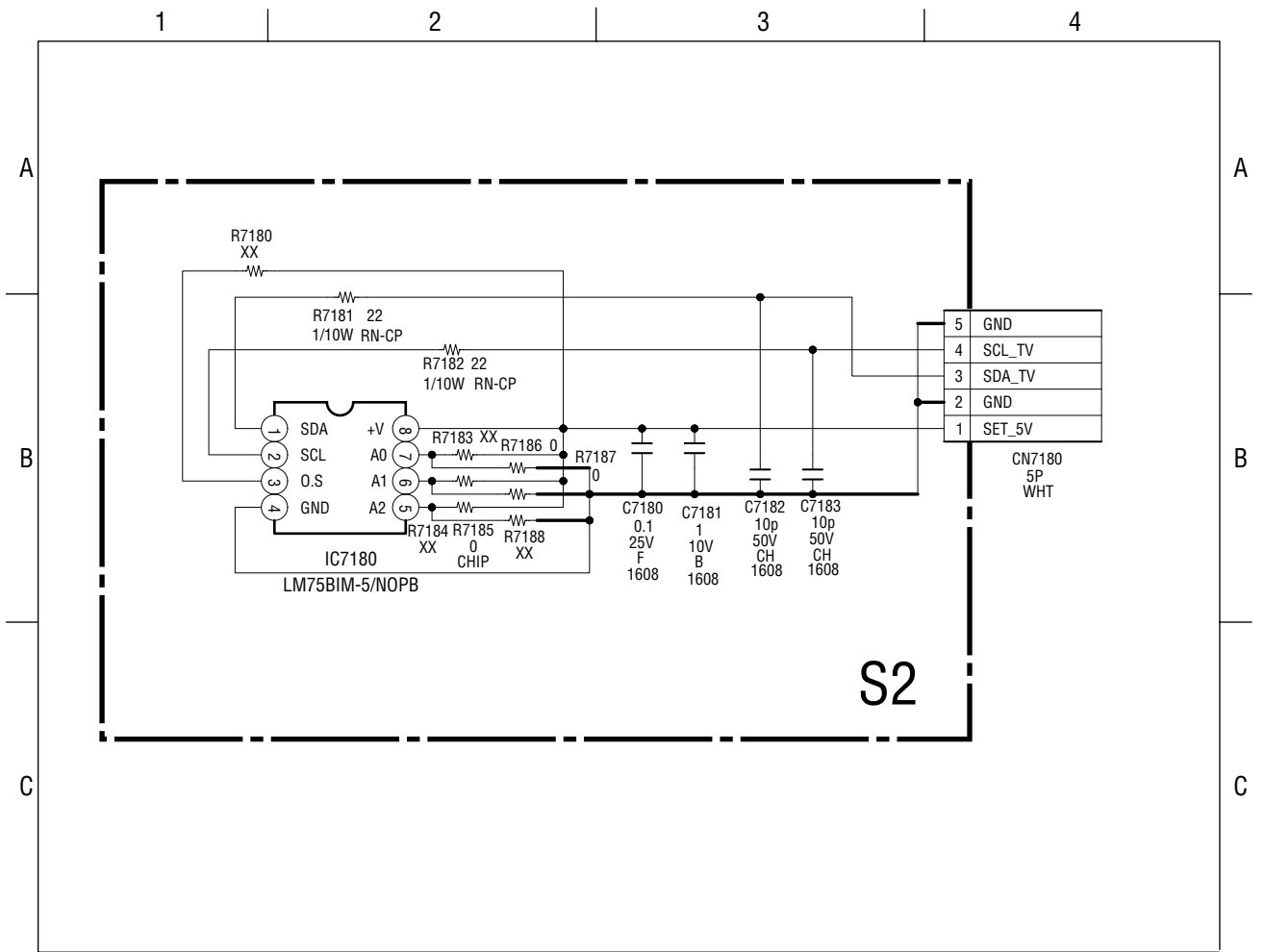

(11) Schematic Diagram of T1 Board

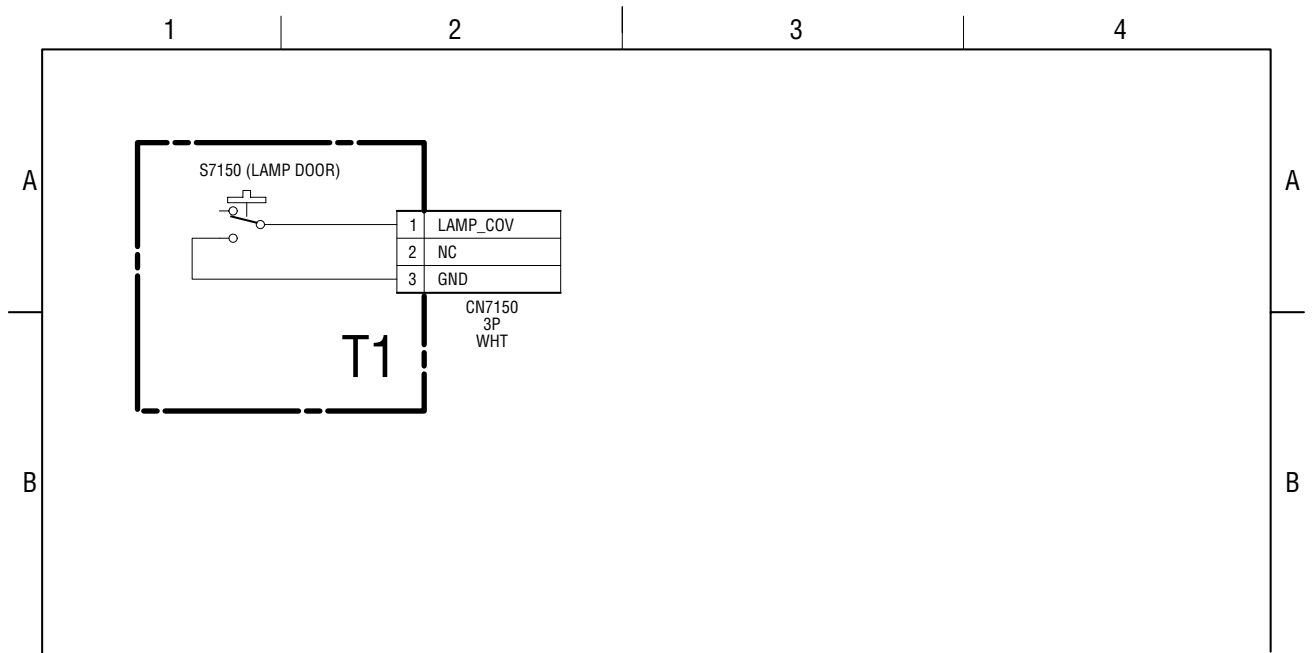

(12) Schematic Diagram of T2 Board

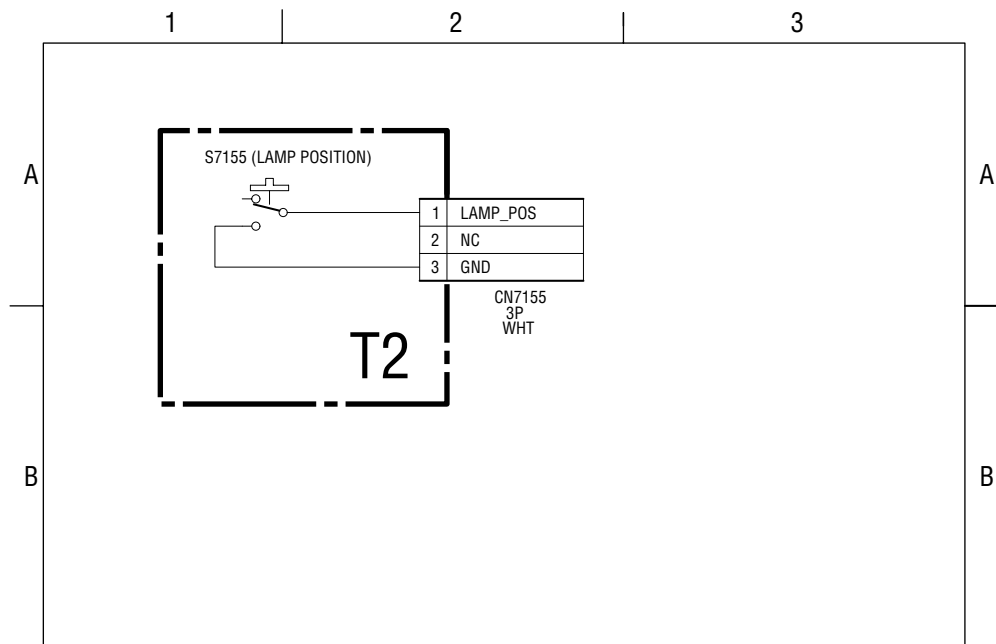

4-5. PRINTED WIRING BOARDS

(1) GT Board

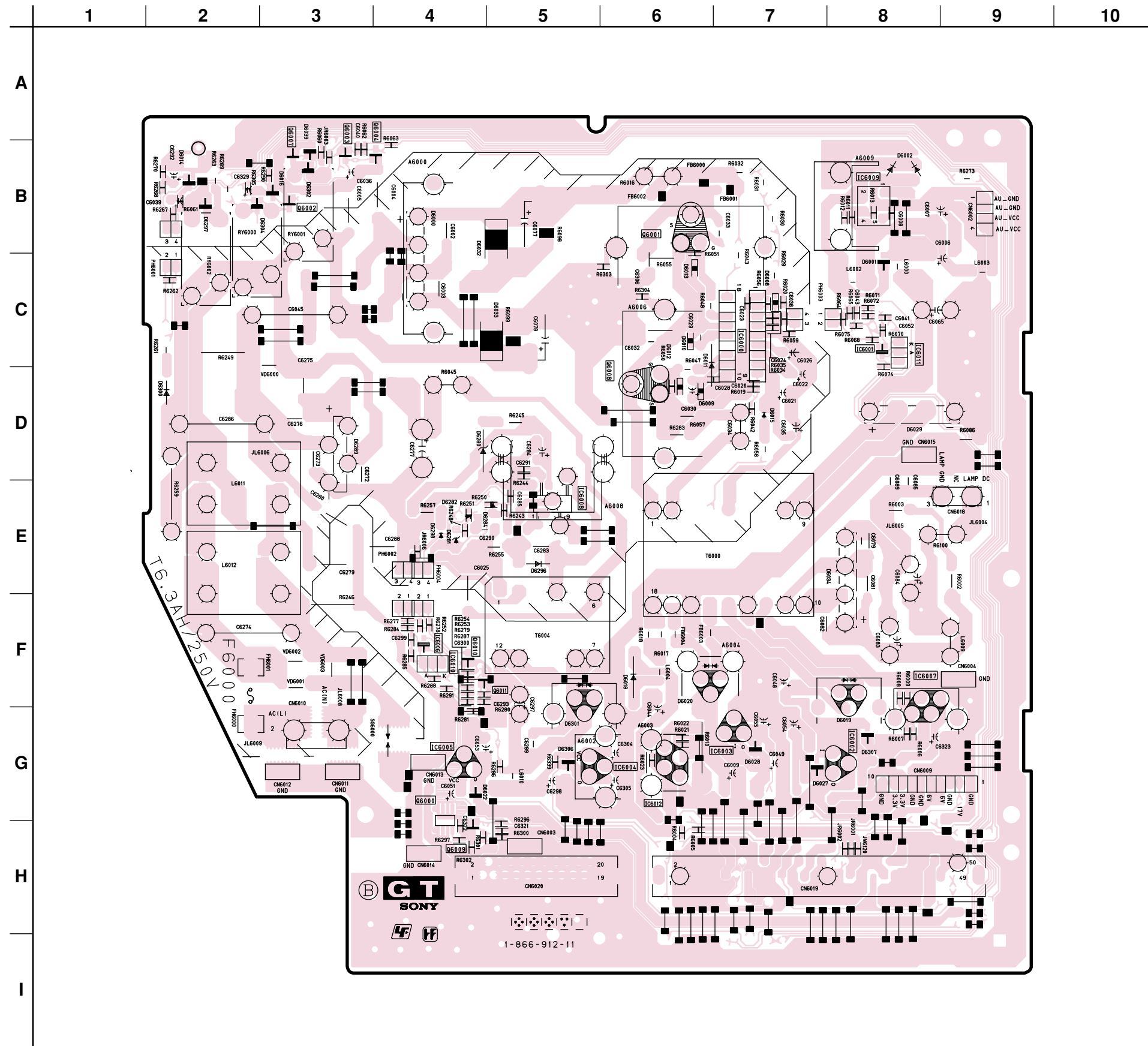

• GT BOARD SEMICONDUCTOR LOCATION

IC		Side A	Side B	*
IC6000	C-7			
IC6002	G-8			
IC6003	G-7			
IC6004	G-6			
IC6005	G-4			
IC6007	F-8			
IC6008	F-5			
IC6009	B-8			
IC6010	F-4			
IC6011	C-8			
TRANSISTOR		Side A	Side B	*
Q6000	G-4			
Q6001	B-6			
Q6003	B-3			
Q6004	B-4			
Q6007	B-3			
Q6008	D-6			
Q6009	H-4			
Q6010	F-4			
Q6011	F-5			
DIODE		Side A	Side B	*
D6000	B-4			
D6001	C-8			
D6002	B-8			
D6011	C-6			
D6014	B-2			
D6015	D-7			
D6018	F-6			
D6019	F-8			
D6020	F-6			
D6022	G-4			
D6027	G-7			
D6028	G-7			
D6029	D-8			
D6032	B-5			
D6033	C-5			
D6034	E-8			
D6039	B-3			
D6280	D-4			
D6281	E-4			
D6282	E-4			
D6289	D-3			
D6296	E-5			
D6297	B-2			
D6298	E-4			
D6300	D-2			
D6301	F-5			
D6302	B-3			
D6306	G-5			
D6307	G-8			

(2) HA, HB Boards

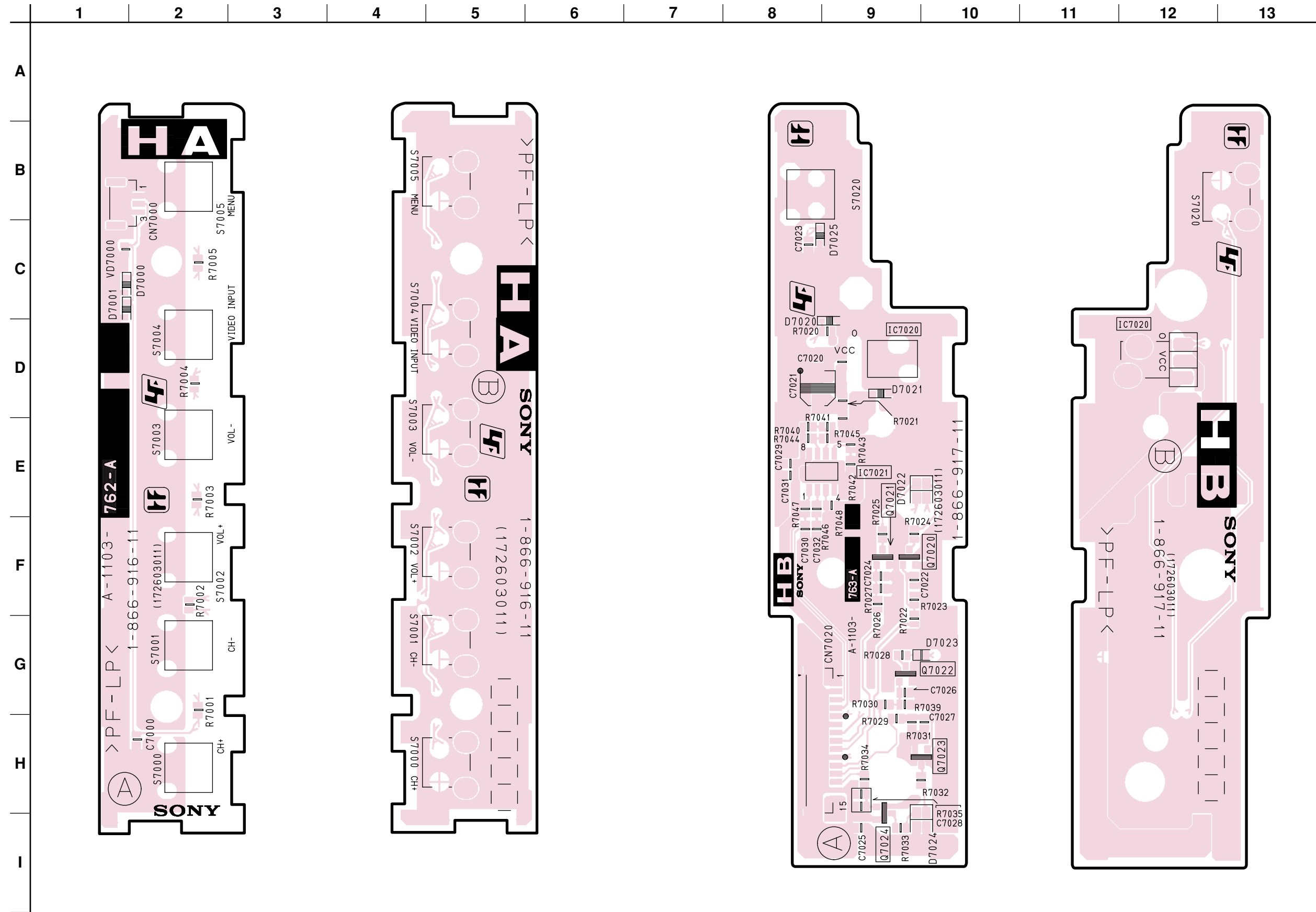

(3) HC, K Boards

	1	2	3	4	5	6	7	8	9	10	11	12	13	14
--	---	---	---	---	---	---	---	---	---	----	----	----	----	----

A
B
C
D
E
F
G
H
I

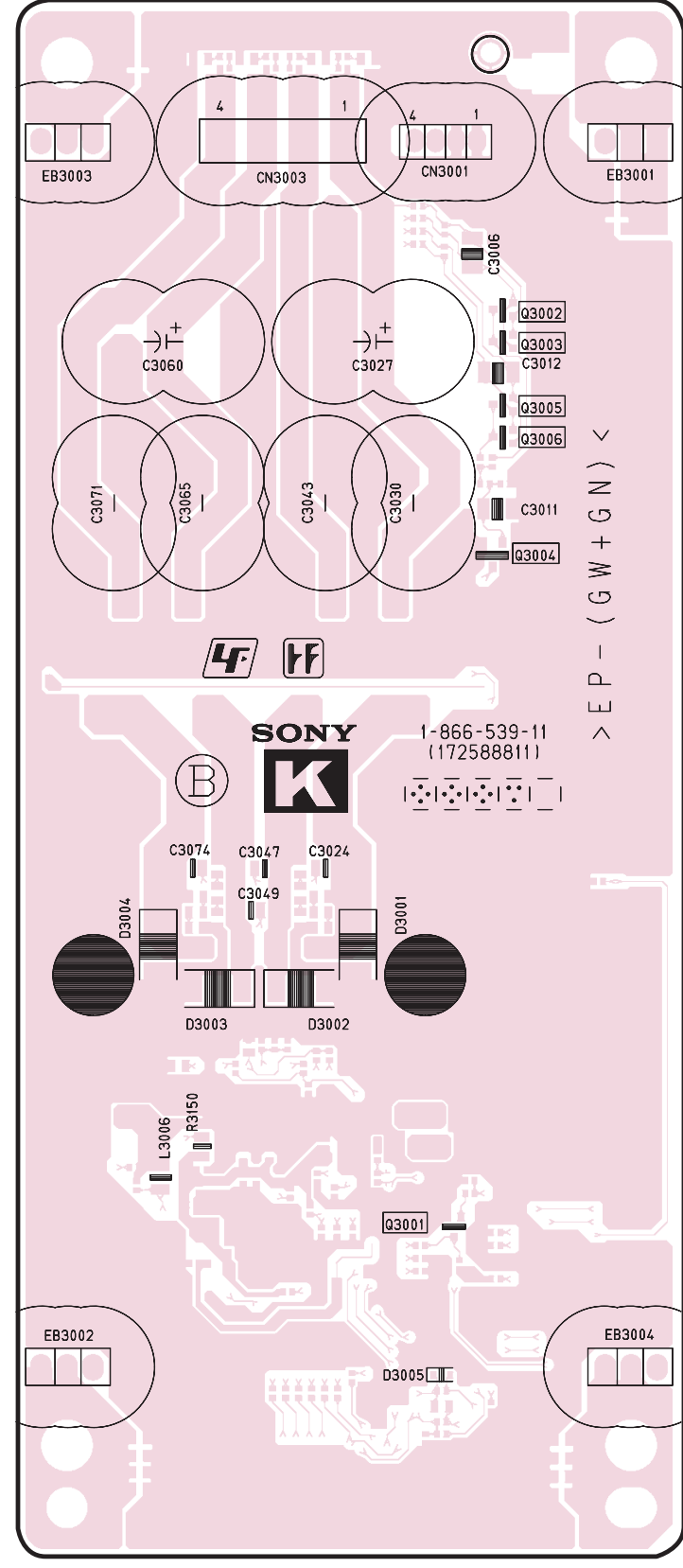
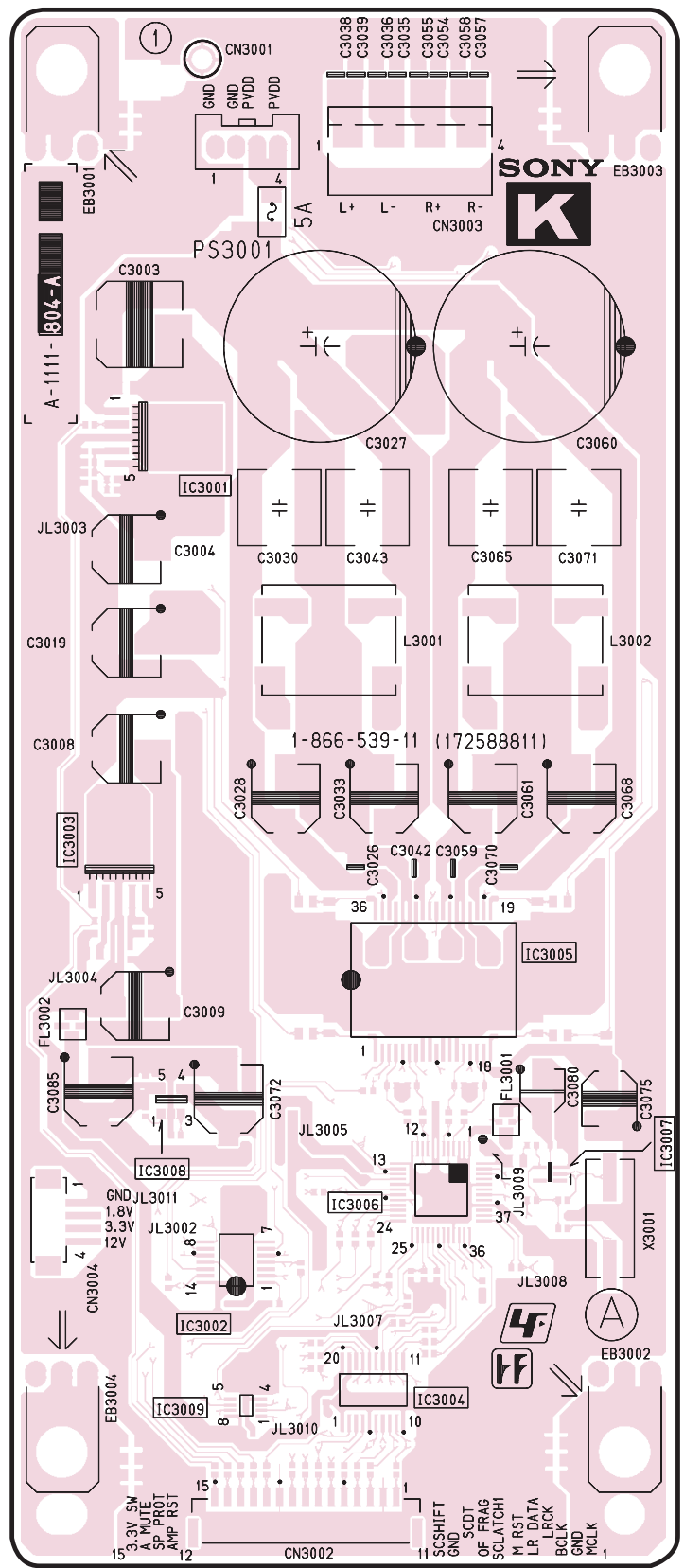
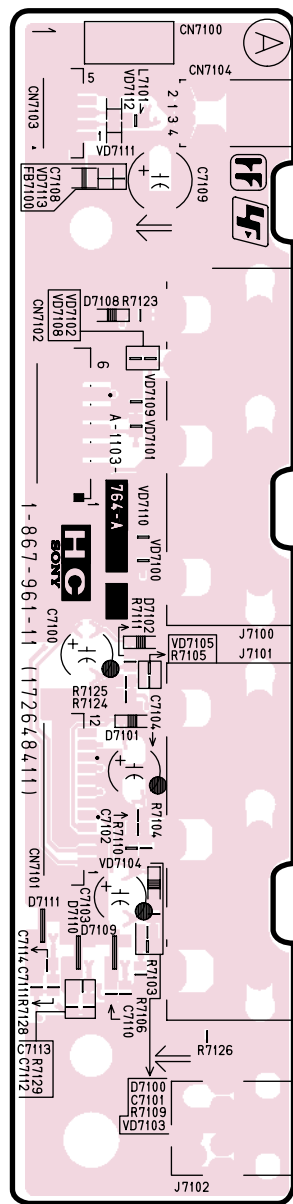
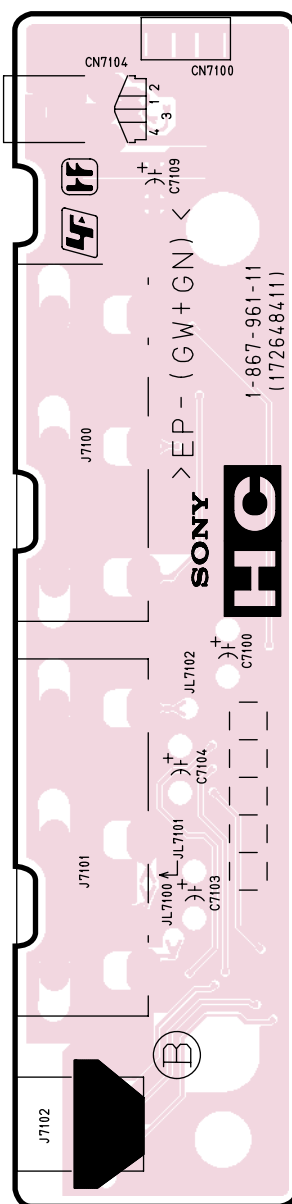

(4) QT Board

1 2 3 4 5 6 7 8 9 10

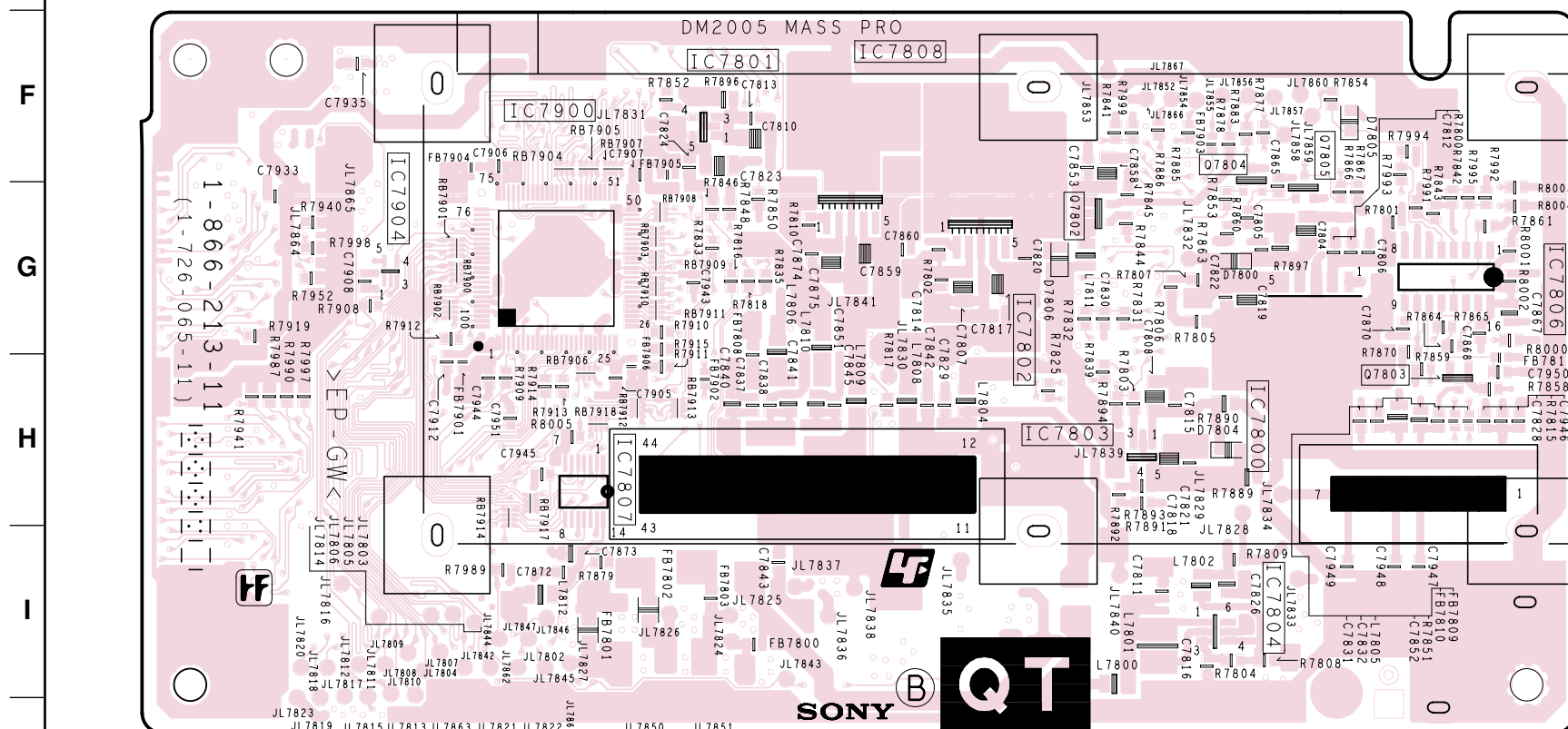
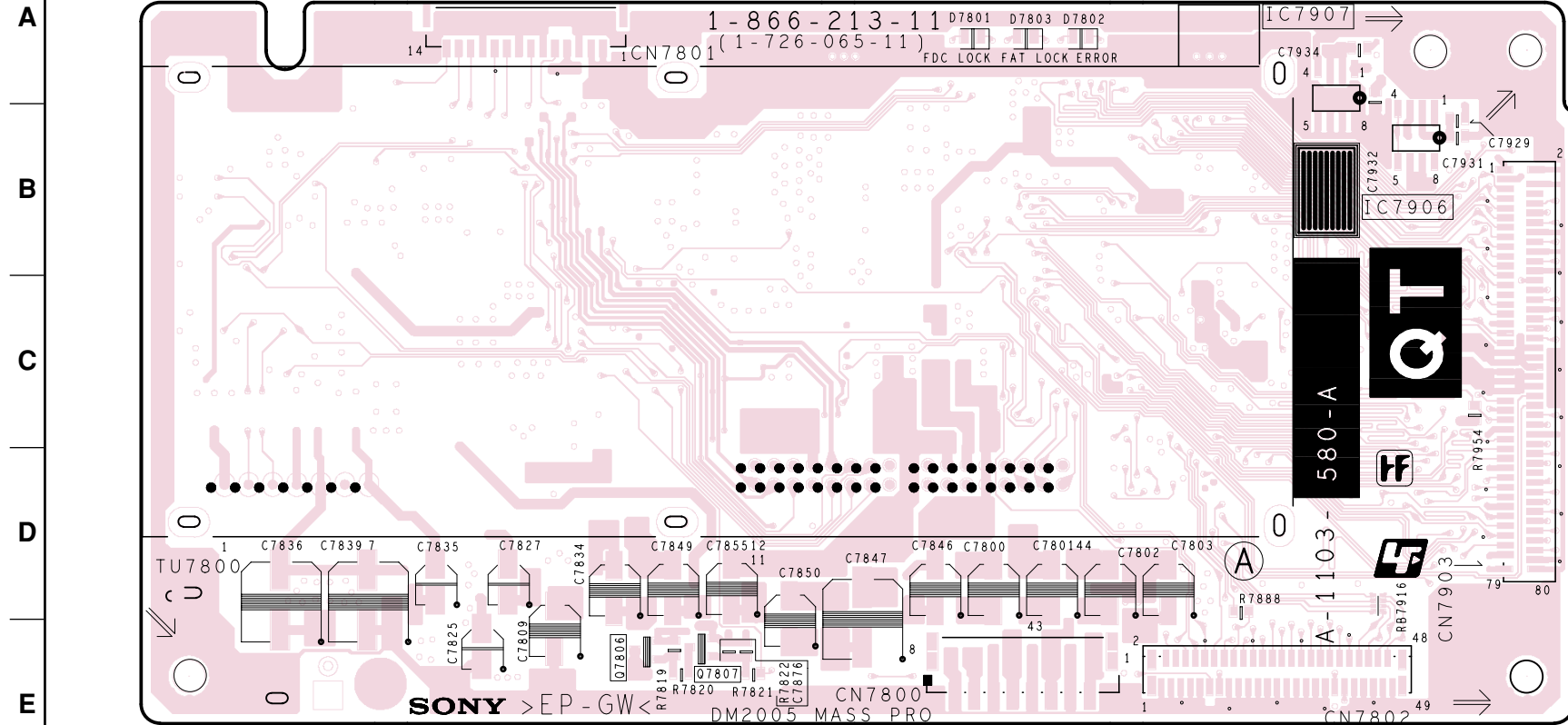

• QT BOARD SEMICONDUCTOR LOCATION

IC	
Side A	Side B
IC7800	H-8
IC7801	F-4
IC7802	F-6
IC7803	H-7
IC7804	I-8
IC7806	G-9
IC7807	H-4
IC7808	F-5
IC7900	G-3
IC7904	G-3
IC7906	B-8
IC7907	A-8
TRANSISTOR	
Side A	Side B
Q7802	G-7
Q7803	H-9
Q7804	E-7
Q7805	F-8
Q7806	E-4
Q7807	E-4
DIODE	
Side A	Side B
D7801	A-6
D7802	A-6
D7803	A-6

(5) QU Board

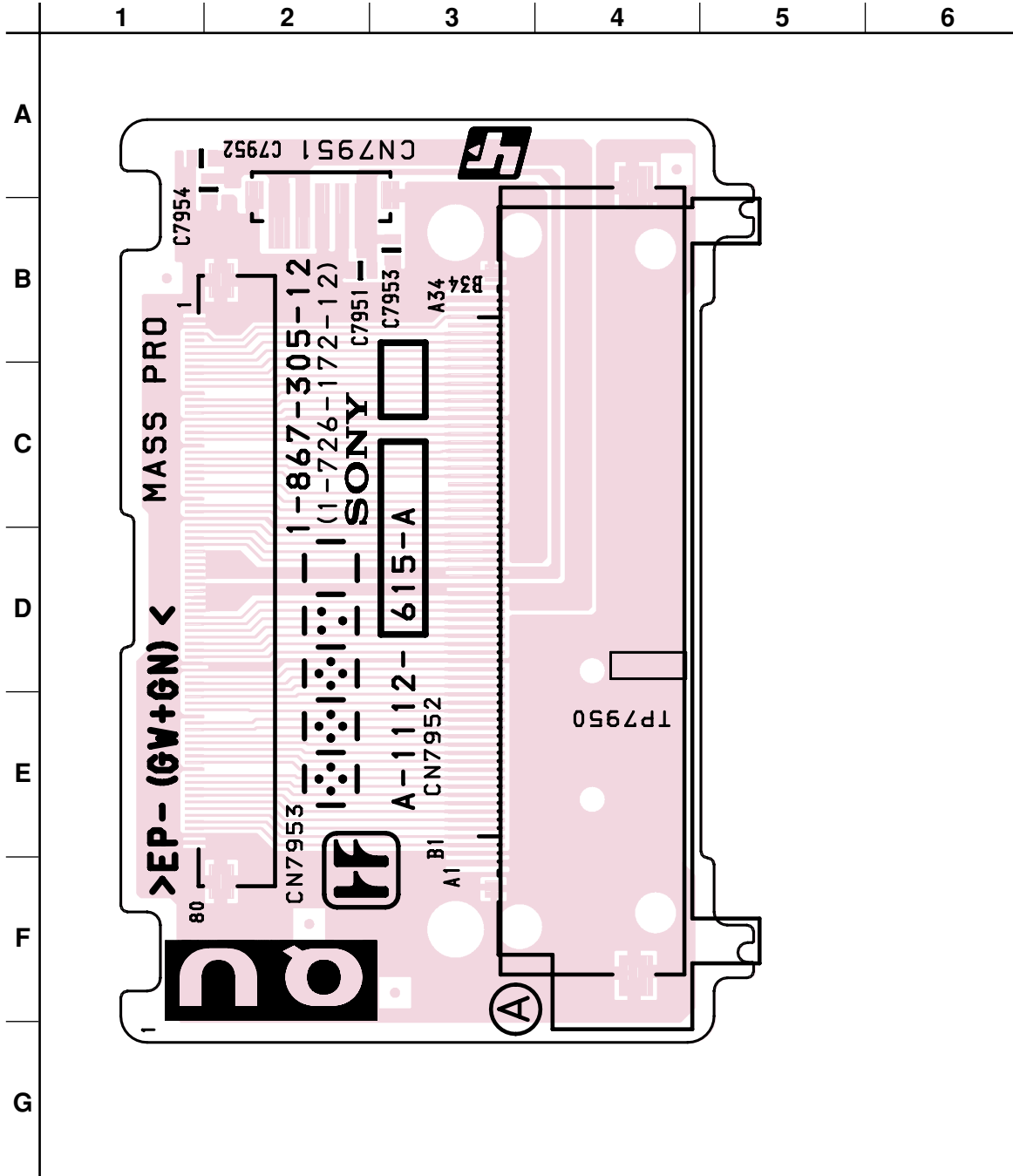

(6) S2 Board

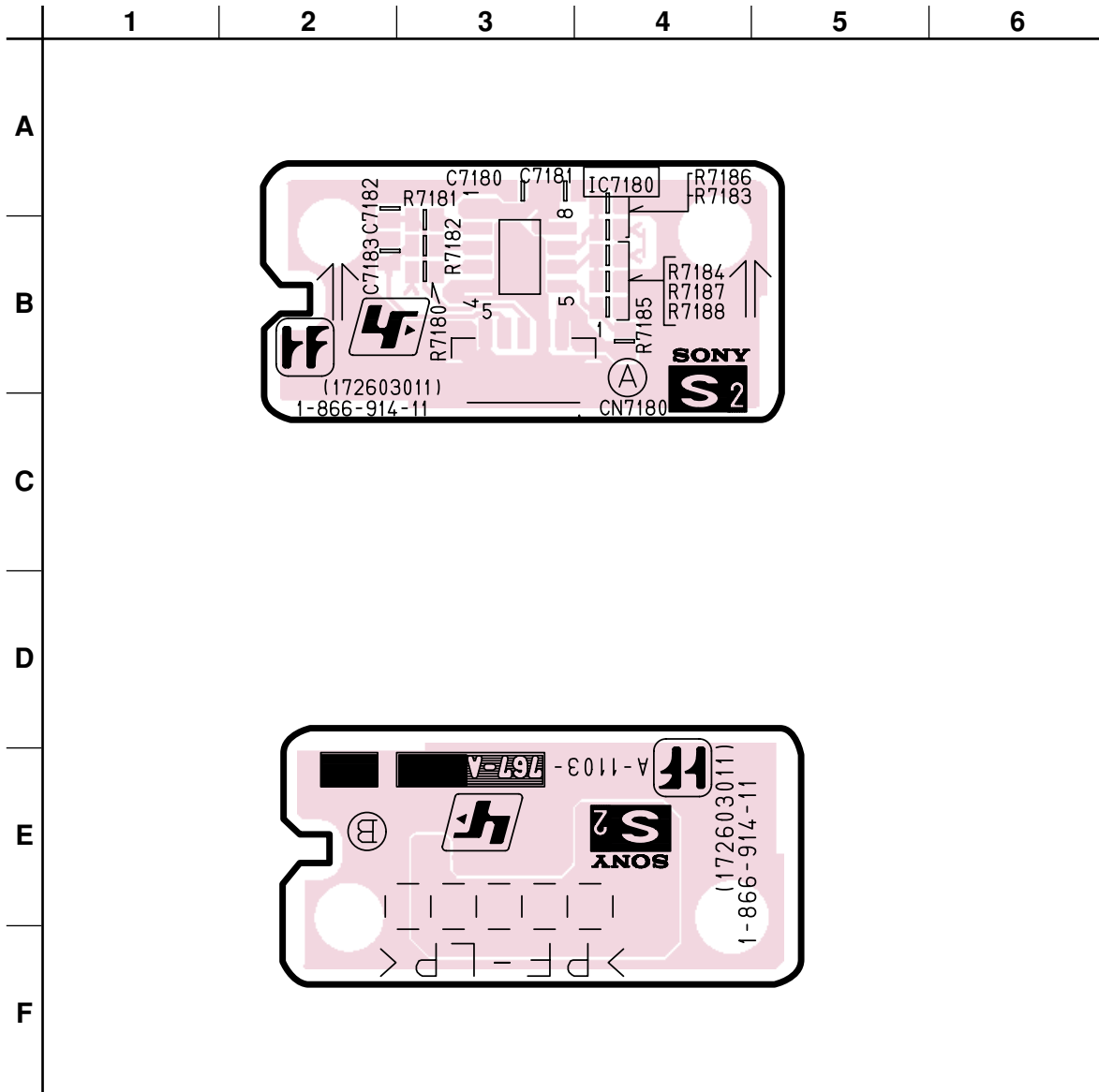

(7) T1, T2 Boards

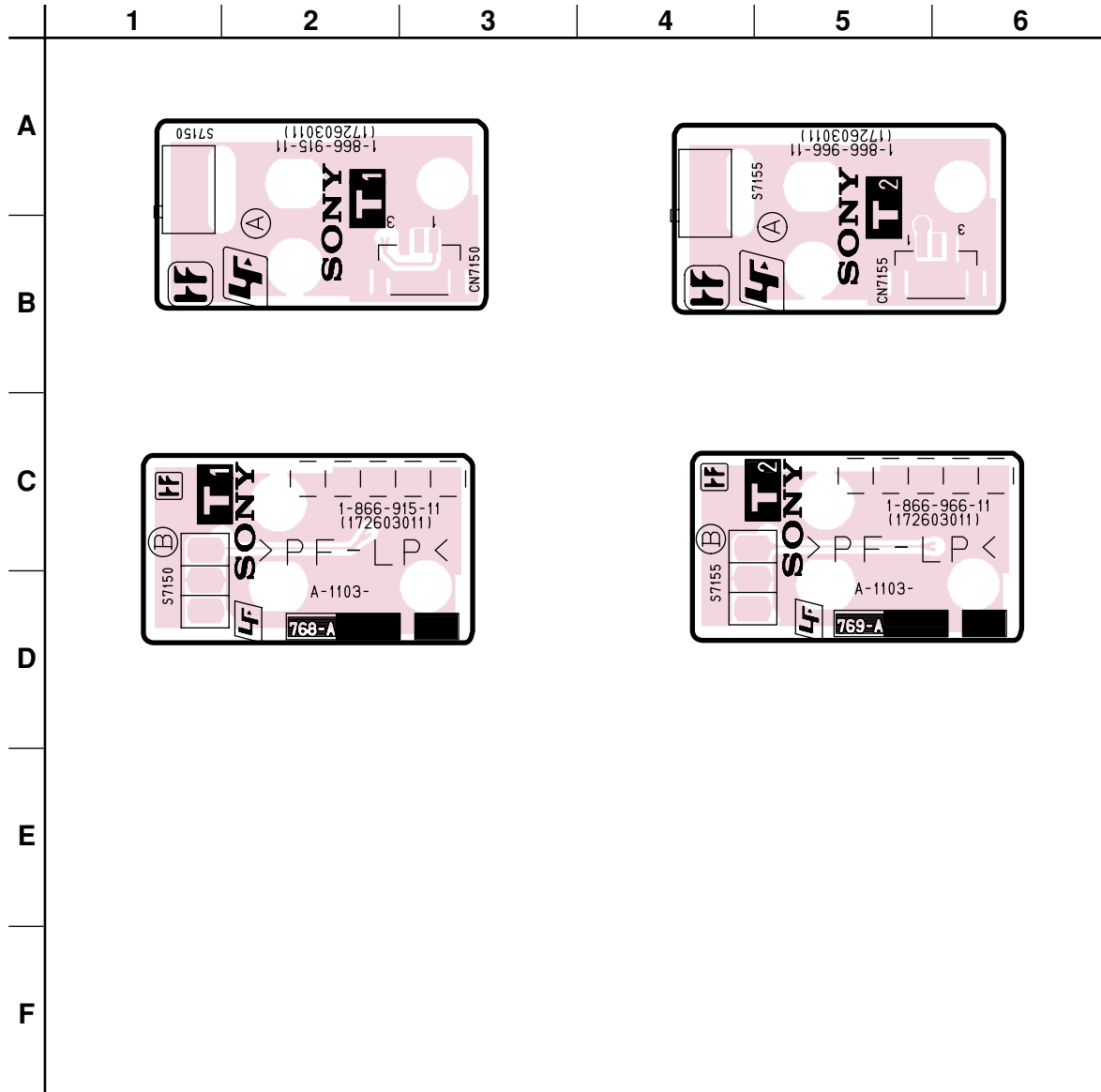

4-6. SEMICONDUCTORS

LM75BIM-5/NOPB
 M24C02-WMN6T(B)

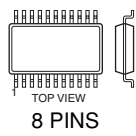

1SS184

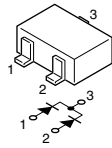

P6SMB39AT3
 S3G

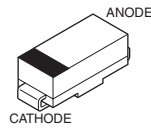

MCZ3001DB

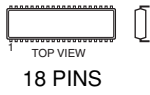

D10SC4M-F
 D10SC6M-4012

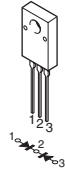

SML-020MVT-T86

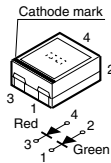

MM1431ATT
 NJM2870F18 (TE2)
 XXC6219B182MR

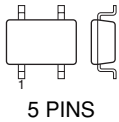

D2L20U-TA
 RD8.2ES-B2

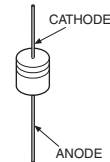

SML-210MT-T86
 SML-210VTT86
 SML-310LTT86

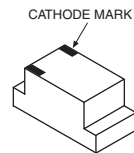

NJM2387DL2-TE1

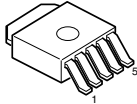

PQ1CG2032FZ

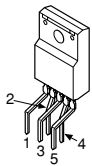

D2SB60A-F04
 D2SB60L
 D4SBL40
 D4SBS6-F

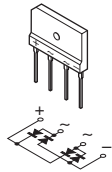

PQ30RV11

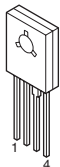

D5LC20U-4012

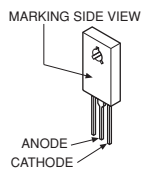

RPM7240-H8

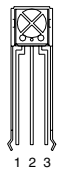

DTZ10B
 HZU5.6GTRF
 MA111-TX
 UDZS-TE17-5.6B

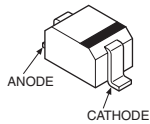

2SC1623-L5L6
 UPA1716G

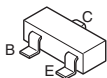

ERA22-08TP3

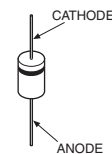

10ERB20-TB3
 UF4005/23

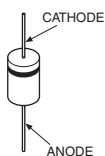

SECTION 5 EXPLODED VIEWS

NOTE:

- Items with no part number and no description are not stocked because they are seldom required for routine service
- The construction parts of an assembled part are indicated with a collation number in the remark column.
- Items marked " * " are not stocked since they are seldom required for routine service. Some delay should be anticipated when ordering these items.

The components identified by shading and mark are critical for safety. Replace only with part number specified.

Les composants identifiés par une trame et une marque sont critiques pour la sécurité. Ne les remplacer que par une pièce portant le numéro spécifié.

5-1. SCREEN MIRROR BLOCK, COVERS

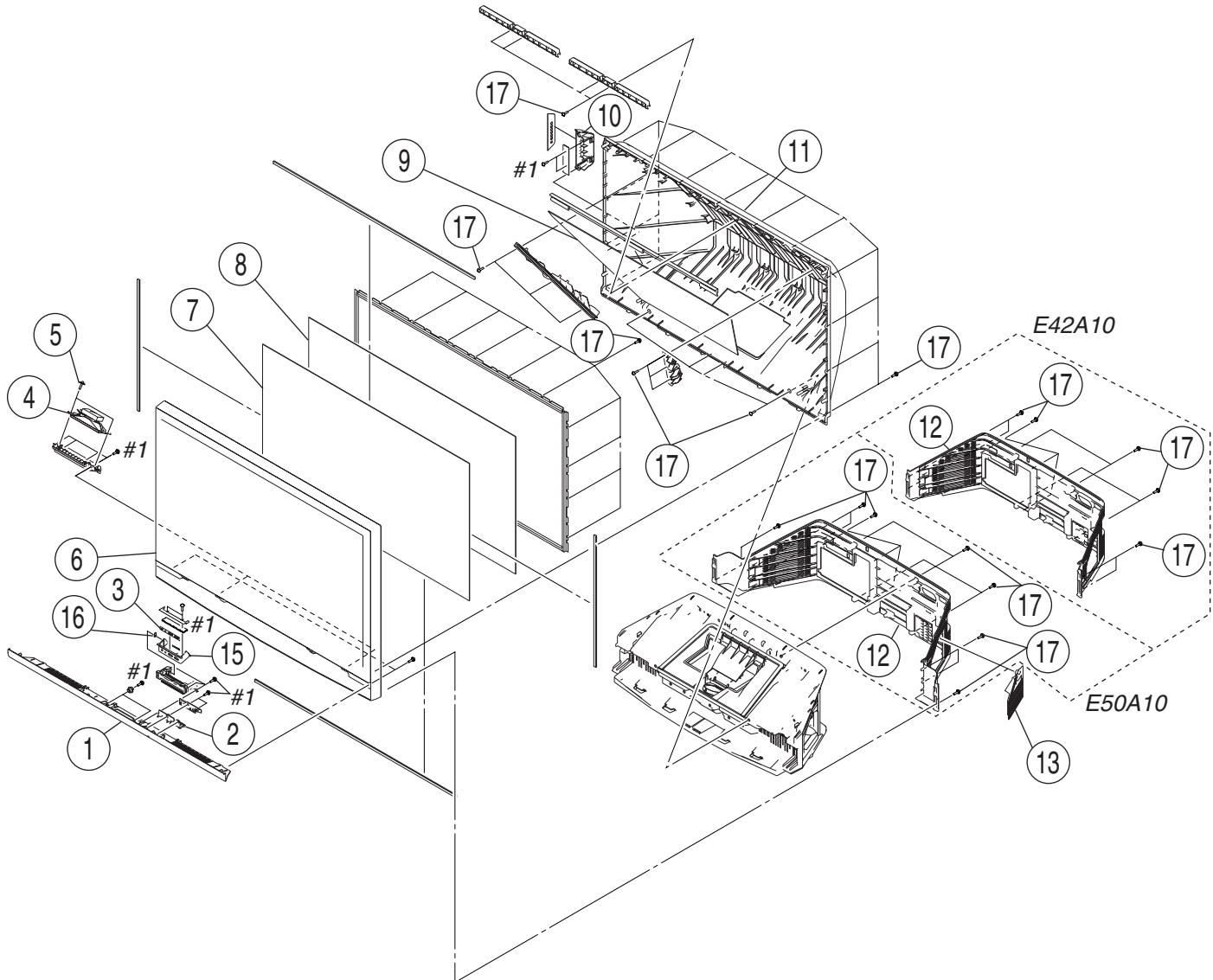

REF. NO.	PART NO.	DESCRIPTION	REMARK	REF. NO.	PART NO.	DESCRIPTION	REMARK
1	2-590-903-01	GRILL, SPEAKER (42)	(E42A10)	9	A-1127-077-A	MIRROR ASSY	(E42A10)
1	2-590-908-01	GRILL, SPEAKER (50)	(E50A10)	10	2-590-909-01	BRACKET, HC (50)	(E50A10)
2	2-590-913-01	BUTTON, POWER		11	A-1127-075-A	MIRROR COVER ASSY	(E50A10)
3	2-590-914-01	BUTTON, MULTI		11	A-1127-078-A	MIRROR COVER ASSY	(E42A10)
4	1-826-219-11	LOUD SPEAKER (5X15cm)		12	2-591-155-01	COVER,REAR	(E50A10)
5	2-580-654-01	SCREW, +PWTP2 4X16		12	2-591-155-11	COVER,REAR	(E42A10)
6	A-1127-073-A	SCREEN FRAME ASSY	(E50A10)	13	2-591-156-01	DOOR,LAMP	
6	A-1127-076-A	SCREEN FRAME ASSY	(E42A10)	14	4-097-548-01	CUSHION, FOOT	
7	2-590-449-11	PLATE(42L),DIFFUSION	(E42A10)	15	2-590-915-01	TRAY, CONTROL	
7	2-590-451-11	PLATE(50L),DIFFUSION	(E50A10)	16	2-593-048-01	DAMPER	
8	2-590-450-11	PLATE(42F),DIFFUSION	(E42A10)	17	2-580-640-01	SCREW, +BVTP2 4X16	
8	2-590-452-11	PLATE(50F),DIFFUSION	(E50A10)	#1	7-685-648-79	SCREW +BVTP 3X12 TYPE2 IT-3	
9	A-1127-074-A	MIRROR ASSY	(E50A10)				

5-2. B BLOCK, CHASSIS ASSEMBLY

The components identified by shading and mark Δ are critical for safety. Replace only with part number specified.

Les composants identifiés par une trame et une marque Δ sont critiques pour la sécurité. Ne les remplacer que par une pièce portant le numéro spécifié.

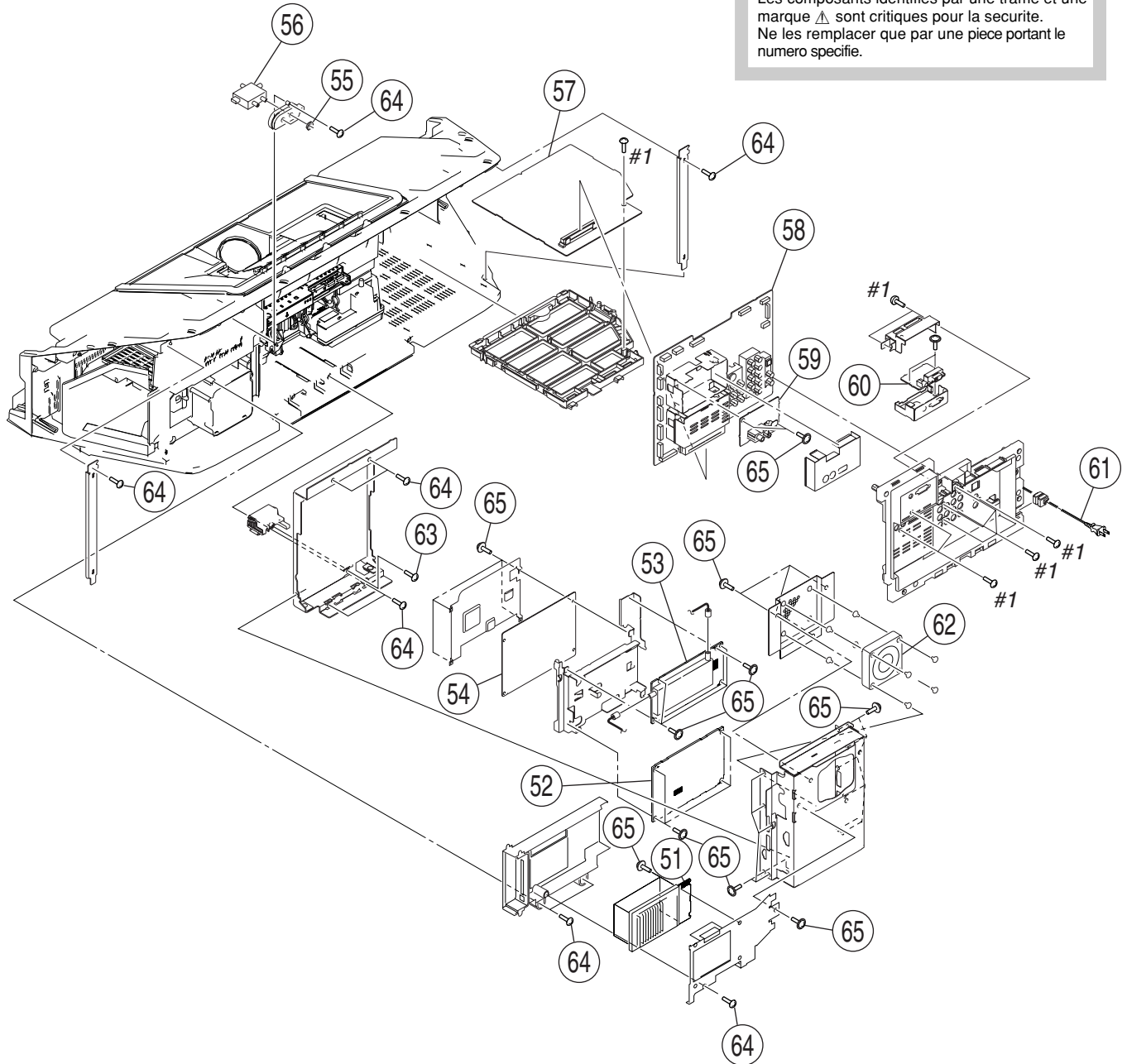

REF. NO.	PART NO.	DESCRIPTION	REMARK	REF. NO.	PART NO.	DESCRIPTION	REMARK
51	* A-1073-391-A	QU BOARD, COMPLETE		60	A-1138-521-A	HPC BOARD, COMPLETE	
52	A-1129-347-A	QM BOARD, COMPLETE		61	Δ 1-791-192-21	CORD, NOISE FILTER WITH POWER	
53	A-1103-580-A	QT BOARD, COMPLETE		62	Δ 1-787-333-11	D.C. FAN	
54	A-1129-348-A	B BOARD, COMPLETE		63	3-701-810-72	SCREW, TERMINAL	
55	3-682-691-00	NUT, WASHER HEXAGON		64	2-580-640-01	SCREW, +BVTP2 4X16	
56	8-597-504-00	ANTENNA SWITCHE RFD-SA811		65	2-580-593-01	SCREW, +PSW M3X8	
57	A-1113-732-A	GT BOARD, COMPLETE		#1	7-685-648-79	SCREW +BVTP 3X12 TYPE2 IT-3	
58	A-1129-346-A	AGU BOARD, COMPLETE					
59	A-1129-345-A	P BOARD, COMPLETE					

5-3. LAMP DUCT ASSEMBLY, OPTICS UNIT BLOCK

The components identified by shading and mark \triangle are critical for safety. Replace only with part number specified.

Les composants identifiés par une trame et une marque \triangle sont critiques pour la sécurité. Ne les remplacer que par une pièce portant le numéro spécifié.

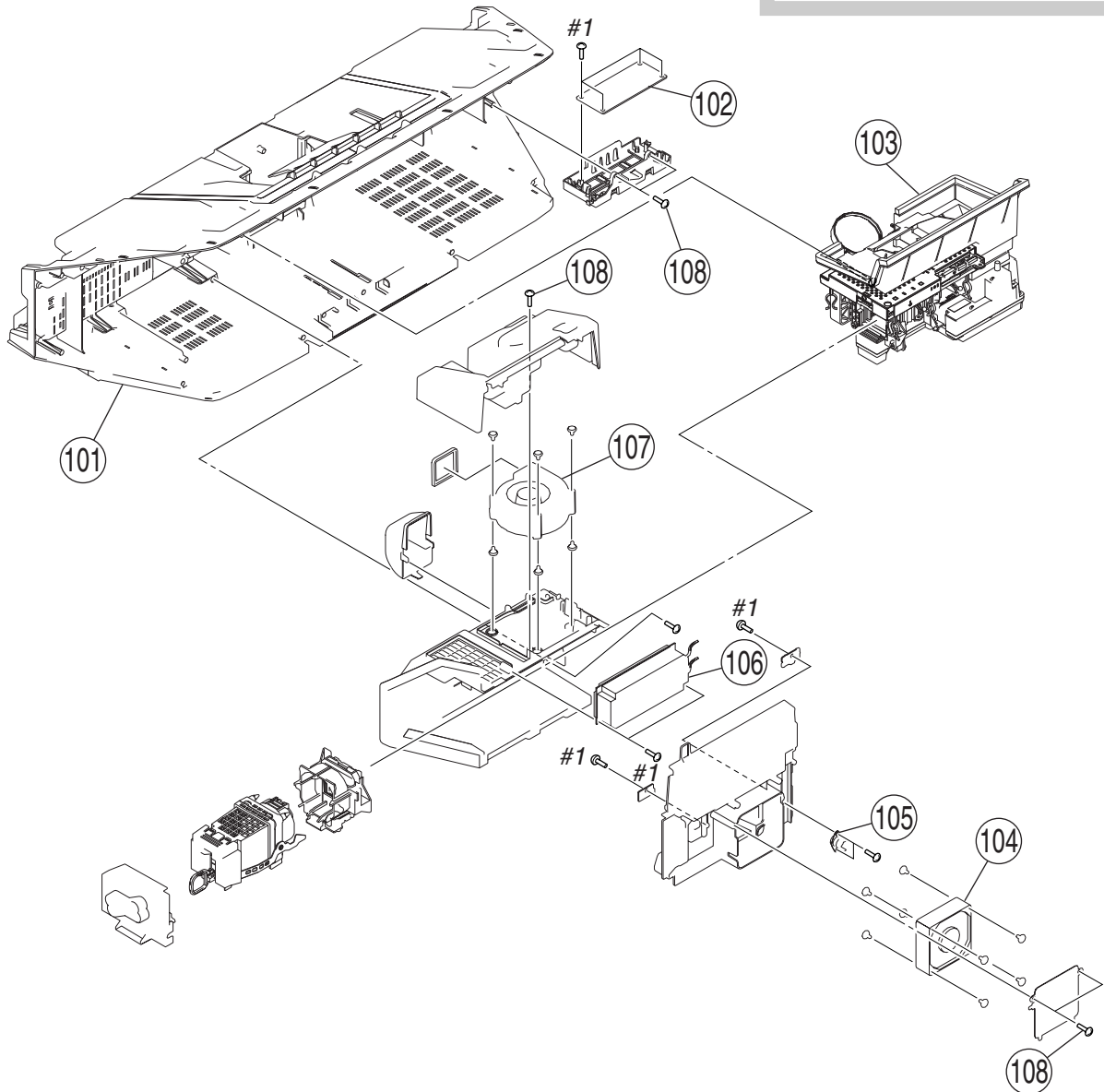

REF. NO.	PART NO.	DESCRIPTION	REMARK
101	X-2055-656-1	CABINET ASSY, BOTTOM(42) (E42A10)	
101	X-2055-653-1	CABINET ASSY, BOTTOM(50) (E50A10)	
102	A-1115-002-A	K BOARD, COMPLETE	
103	A-1123-069-A	OPTICS UNIT BLOCK ASSY (E50A10)	
103	A-1123-071-A	OPTICS UNIT BLOCK ASSY (E42A10)	
104	\triangle 1-787-373-11	FAN,DC	

REF. NO.	PART NO.	DESCRIPTION	REMARK
105	1-576-912-11	THERMOSTAT	
106	\triangle 1-468-936-11	POWER SUPPLY BLOCK	
107	\triangle 1-787-231-11	D.C. FAN (SIROCCO)	
108	2-580-640-01	SCREW, +BVTP2 4X16	
#1	7-685-648-79	SCREW +BVTP 3X12 TYPE2 IT-3	

SECTION 6

ELECTRICAL PARTS LIST

GT

The components identified by shading and mark Δ are critical for safety. Replace only with part number specified.

Les composants identifiés par une trame et une marque Δ sont critiques pour la sécurité. Ne les remplacer que par une pièce portant le numéro spécifié.

When indicating parts by reference number, please include the board name.

• Items marked " * " are not stocked since they are seldom required for routine service. Some delay should be anticipated when ordering these items.

• All variable and adjustable resistors have characteristic curve B, unless otherwise noted.

• RESISTORS
All resistors are in ohms
F : nonflammable

• CAPACITORS
PF : $\mu\mu\text{F}$

• There are some cases the reference number on one board overlaps on the other board. Therefore, when ordering parts by the reference number, please include the board name.

REF. NO.	PART NO.	DESCRIPTION	REMARK	REF. NO.	PART NO.	DESCRIPTION	REMARK
	A-1113-732-A	GT BOARD, COMPLETE *****		C6279	Δ 1-119-888-51	CERAMIC 2200PF	20% 250V
	4-382-854-01	SCREW (M3X8), P, SW (+)		C6280	Δ 1-119-888-51	CERAMIC 2200PF	20% 250V
		< CAPACITOR >		C6283	1-162-116-00	CERAMIC 680PF	10% 2KV
C6006	1-128-953-31	ELECT 470UF	20% 25V	C6284	1-126-950-11	ELECT 330UF	20% 35V
C6007	1-128-953-31	ELECT 470UF	20% 25V	C6285	1-164-217-11	CERAMIC CHIP 150PF	5% 50V
C6008	1-162-966-11	CERAMIC CHIP 0.0022UF	10% 50V	C6286	Δ 1-165-530-31	MYLAR 0.47UF	10 0V
C6020	1-162-970-11	CERAMIC CHIP 0.01UF	10% 25V	C6289	1-137-353-11	MYLAR 0.047UF	5% 100V
C6021	1-126-967-11	ELECT 47UF	20% 50V	C6290	1-137-365-11	MYLAR 0.0015UF	5% 50V
C6022	1-126-962-11	ELECT 3.3UF	20% 50V	C6291	1-162-964-11	CERAMIC CHIP 0.001UF	10% 50V
C6023	1-162-970-11	CERAMIC CHIP 0.01UF	10% 25V	C6292	1-126-934-11	ELECT 220UF	20% 16V
C6024	1-100-831-91	CERAMIC CHIP 0.001UF	2% 50V	C6297	1-137-852-31	ELECT 3300UF	20% 16V
C6026	1-126-964-11	ELECT 10UF	20% 50V	C6298	1-126-935-11	ELECT 470UF	20% 16V
C6028	1-162-970-11	CERAMIC CHIP 0.01UF	10% 25V	C6299	1-164-227-11	CERAMIC CHIP 0.022UF	10% 25V
C6029	1-136-497-81	FILM 0.1UF	5% 50V	C6300	1-110-563-11	CERAMIC CHIP 0.068UF	10% 16V
C6030	1-126-947-11	ELECT 47UF	20% 35V	C6304	1-126-947-11	ELECT 47UF	20% 35V
C6032	1-107-824-11	CERAMIC 220PF	5% 1KV	C6305	1-126-947-11	ELECT 47UF	20% 35V
C6033	1-107-824-11	CERAMIC 220PF	5% 1KV	C6323	1-126-935-11	ELECT 470UF	20% 16V
C6034	1-165-954-11	FILM 56000PF	3% 800V			< CONNECTOR >	
C6035	1-126-969-11	ELECT 220UF	20% 50V	CN6002	1-794-502-11	PIN, CONNECTOR (B04B-PASK) 4P	
C6036	1-126-963-11	ELECT 4.7UF	20% 50V	CN6009	1-785-706-11	PIN, CONNECTOR (PC BOARD) 10P	
C6039	1-126-963-11	ELECT 4.7UF	20% 50V	CN6010	Δ 1-580-843-11	PIN, CONNECTOR (POWER)	
C6040	1-107-826-11	CERAMIC CHIP 0.1UF	10% 16V	CN6011	1-695-915-11	TAB (CONTACT)	
C6041	1-162-970-11	CERAMIC CHIP 0.01UF	10% 25V	CN6012	1-695-915-11	TAB (CONTACT)	
C6044	1-126-940-11	ELECT 330UF	20% 25V	CN6013	1-695-915-11	TAB (CONTACT)	
C6045	Δ 1-165-530-31	MYLAR 0.47UF	10 0V	CN6014	1-695-915-11	TAB (CONTACT)	
C6048	1-128-951-31	ELECT 2200UF	20% 16V	CN6015	1-695-915-11	TAB (CONTACT)	
C6049	1-128-951-31	ELECT 2200UF	20% 16V	CN6018	1-691-960-21	PIN, CONNECTOR (PC BOARD) 3P	
C6051	1-126-933-11	ELECT 100UF	20% 16V	CN6019	1-815-789-11	CONNECTOR, BOARD TO BOARD 50P	
C6052	1-137-190-91	FILM 0.22UF	5% 50V			< DIODE >	
C6053	1-126-947-11	ELECT 47UF	20% 35V	D6000	Δ 8-719-510-53	DIODE D4SB60L	
C6054	1-126-935-11	ELECT 470UF	20% 16V	D6001	6-500-335-01	DIODE MC2838-T112-1	
C6055	1-126-947-11	ELECT 47UF	20% 35V	D6002	8-719-510-12	DIODE D10SC4M-F	
C6065	1-128-548-11	ELECT 4700UF	20% 25V	D6011	8-719-979-64	DIODE UF4005/23	
C6077	Δ 1-131-940-11	ELECT 1200UF	20% 250V	D6014	6-500-335-01	DIODE MC2838-T112-1	
C6078	Δ 1-131-940-11	ELECT 1200UF	20% 250V	D6015	6-500-567-31	DIODE 10ERB20-TB3	
C6083	1-100-714-11	ELECT 100UF	20% 400V	D6018	8-719-028-45	DIODE D2L20U-TA	
C6084	1-100-714-11	ELECT 100UF	20% 400V	D6019	8-719-057-96	DIODE D10SC6M-4012	
C6085	1-161-830-00	CERAMIC 0.0047UF	500V	D6020	8-719-075-66	DIODE D5LC20U-4012	
C6272	Δ 1-161-964-91	CERAMIC 0.0047UF	250V	D6022	6-500-335-01	DIODE MC2838-T112-1	
C6273	Δ 1-161-964-91	CERAMIC 0.0047UF	250V	D6027	6-500-335-01	DIODE MC2838-T112-1	
C6274	Δ 1-165-530-31	MYLAR 0.47UF	10 0V	D6028	6-500-335-01	DIODE MC2838-T112-1	
C6275	Δ 1-161-964-91	CERAMIC 0.0047UF	250V	D6029	8-719-060-89	DIODE D4SBS6-F	
C6276	1-161-964-91	CERAMIC 0.0047UF	250V	D6032	6-501-223-01	DIODE S3G	
C6277	1-113-610-11	ELECT(BLOCK) 220UF	20% 250V	D6033	6-501-223-01	DIODE S3G	

Les composants identifiés par une trame et une marque Δ sont critiques pour la sécurité. Ne les remplacer que par une pièce portant le numéro spécifié.

The components identified by shading and mark Δ are critical for safety. Replace only with part number specified.

KDF-E42A10/E50A10

RM-YD003 RM-YD003

GT

REF. NO.	PART NO.	DESCRIPTION	REMARK
D6034	8-719-064-49	DIODE D4SBL40	
D6039	6-500-335-01	DIODE MC2838-T112-1	
D6280	8-719-160-65	DIODE RD16FB2	
D6281	8-719-110-08	DIODE RD8.2ESB2	
D6282	6-500-567-31	DIODE 10ERB20-TB3	
D6289 Δ	8-719-077-76	DIODE D2SB60A-F04	
D6296	8-719-055-45	DIODE ERA22-08TP3	
D6297	6-500-335-01	DIODE MC2838-T112-1	
D6298	6-500-567-31	DIODE 10ERB20-TB3	
D6300	8-719-948-45	DIODE ERA22-08	
D6301	8-719-057-96	DIODE D10SC6M-4012	
D6302	6-500-335-01	DIODE MC2838-T112-1	
D6306	6-500-335-01	DIODE MC2838-T112-1	
D6307	6-500-335-01	DIODE MC2838-T112-1	
< FUSE >			
F6000 Δ	1-532-506-51	FUSE 6.3A 250V	
< FERRITE BEAD >			
FB6000	1-410-396-41	FERRITE 0.45UH	
FB6001	1-410-396-41	FERRITE 0.45UH	
FB6002	1-410-396-41	FERRITE 0.45UH	
FB6003	1-412-911-11	FERRITE 0UH	
FB6004	1-412-911-11	FERRITE 0UH	
< FUSE HOLDER >			
FH6000 Δ	1-533-223-11	FUSE HOLDER	
FH6001 Δ	1-533-223-11	FUSE HOLDER	
< IC >			
IC6000	6-705-810-01	IC MCZ3001DB	
IC6002	6-705-464-01	IC BA50BC0T	
IC6003	6-705-466-01	IC BA90BC0T	
IC6004	6-705-464-01	IC BA50BC0T	
IC6005	6-705-464-01	IC BA50BC0T	
IC6007	8-759-098-24	IC PQ30RV11J00H	
IC6008	6-708-175-01	IC MR4010-7103	
IC6009	8-759-640-19	IC PQ1CG2032FZ	
IC6010	8-759-682-42	IC MM1431ATT	
IC6011	8-759-682-42	IC MM1431ATT	
< COIL >			
L6000	1-406-659-11	INDUCTOR 10UH	
L6002	1-419-742-12	INDUCTOR 33UH	
L6003	1-406-659-11	INDUCTOR 10UH	
L6004	1-412-525-31	INDUCTOR 10UH	
L6009	1-406-983-11	INDUCTOR 1MH	
L6010	1-406-661-21	INDUCTOR 22UH	
L6011 Δ	1-456-859-11	LINE FILTER COIL	
L6012 Δ	1-456-859-11	LINE FILTER COIL	
< PHOTOCOUPLER >			
PH6001 Δ	6-600-187-01	PHOTOCOUPLER PC123Y22JOOF	
PH6002 Δ	6-600-187-01	PHOTOCOUPLER PC123Y22JOOF	
PH6003 Δ	6-600-187-01	PHOTOCOUPLER PC123Y22JOOF	
PH6004 Δ	6-600-187-01	PHOTOCOUPLER PC123Y22JOOF	

REF. NO.	PART NO.	DESCRIPTION	REMARK
< TRANSISTOR >			
Q6000	8-729-054-36	TRANSISTOR UPA1716G-E2	
Q6001	6-550-882-01	TRANSISTOR 2SK3568(LBS2SONY,Q	
Q6003	8-729-600-22	TRANSISTOR 2SA1235-F	
Q6004	8-729-120-28	TRANSISTOR 2SC1623-L5L6	
Q6007	8-729-120-28	TRANSISTOR 2SC1623-L5L6	
Q6008	6-550-882-01	TRANSISTOR 2SK3568(LBS2SONY,Q	
Q6009	8-729-120-28	TRANSISTOR 2SC1623-L5L6	
Q6010	8-729-120-28	TRANSISTOR 2SC1623-L5L6	
Q6011	8-729-120-28	TRANSISTOR 2SC1623-L5L6	
< RESISTOR >			
R6002	1-215-904-11	METAL OXIDE 100K 5% 2W	
R6003	1-215-904-11	METAL OXIDE 100K 5% 2W	
R6005	1-216-864-11	SHORT CHIP 0	
R6006	1-218-726-11	METAL CHIP 27K 0.5% 1/10W	
R6007	1-218-698-11	METAL CHIP 1.8K 0.5% 1/10W	
R6009	1-216-821-11	METAL CHIP 1K 5% 1/10W	
R6011	1-218-724-11	METAL CHIP 22K 0.5% 1/10W	
R6012	1-218-724-11	METAL CHIP 22K 0.5% 1/10W	
R6013	1-218-692-11	METAL CHIP 1K 0.5% 1/10W	
R6016	1-202-933-61	FUSIBLE 0.1 10% 1/2W	
R6017	1-249-377-11	CARBON 0.47 5% 1/4W	
R6018	1-249-377-11	CARBON 0.47 5% 1/4W	
R6019	1-218-823-11	METAL CHIP 100 0.5% 1/10W	
R6020	1-218-870-11	METAL CHIP 9.1K 0.5% 1/10W	
R6029	1-245-472-21	METAL 270K 1% 1/4W	
R6030	1-245-471-21	METAL 240K 1% 1/4W	
R6031	1-245-471-21	METAL 240K 1% 1/4W	
R6032	1-245-471-21	METAL 240K 1% 1/4W	
R6035	1-218-877-11	METAL CHIP 18K 0.5% 1/10W	
R6042	1-211-991-11	METAL CHIP 82 0.5% 1/10W	
R6043	1-212-897-00	FUSIBLE 470 5% 1/4W	
R6045	1-202-933-61	FUSIBLE 0.1 10% 1/2W	
R6047	1-249-393-11	CARBON 10 5% 1/4W	
R6048	1-249-393-11	CARBON 10 5% 1/4W	
R6050	1-218-871-11	METAL CHIP 10K 0.5% 1/10W	
R6051	1-218-871-11	METAL CHIP 10K 0.5% 1/10W	
R6054	1-245-494-31	METAL 2.2M 2% 1/4W	
R6055	1-245-494-31	METAL 2.2M 2% 1/4W	
R6056	1-216-817-11	METAL CHIP 470 5% 1/10W	
R6057	1-243-979-71	METAL OXIDE 0.1 5% 2W	
R6058	1-249-385-11	CARBON 2.2 5% 1/4W	
R6059	1-216-864-11	SHORT CHIP 0	
R6060	1-216-829-11	METAL CHIP 4.7K 5% 1/10W	
R6061	1-216-833-11	METAL CHIP 10K 5% 1/10W	
R6062	1-216-833-11	METAL CHIP 10K 5% 1/10W	
R6063	1-216-821-11	METAL CHIP 1K 5% 1/10W	
R6064	1-216-821-11	METAL CHIP 1K 5% 1/10W	
R6065	1-216-821-11	METAL CHIP 1K 5% 1/10W	
R6068	1-216-864-11	SHORT CHIP 0	
R6070	1-216-833-11	METAL CHIP 10K 5% 1/10W	
R6072	1-218-722-11	METAL CHIP 18K 0.5% 1/10W	
R6074	1-218-708-11	METAL CHIP 4.7K 0.5% 1/10W	
R6086	1-216-350-11	METAL OXIDE 1.2 5% 1W	
R6089	1-216-864-11	SHORT CHIP 0	
R6098	1-220-340-11	METAL CHIP 470K 5% 1/2W	
R6099	1-220-340-11	METAL CHIP 470K 5% 1/2W	
R6100	1-202-933-61	FUSIBLE 0.1 10% 1/2W	
R6243	1-216-835-11	METAL CHIP 15K 5% 1/10W	
R6244	1-218-720-11	METAL CHIP 15K 0.5% 1/10W	
R6245	1-215-865-11	METAL OXIDE 220 5% 1W	

Les composants identifiés par une trame et une marque Δ sont critiques pour la sécurité. Ne les remplacer que par une pièce portant le numéro spécifié.

The components identified by shading and mark Δ are critical for safety. Replace only with part number specified.

KDF-E42A10/E50A10

RM-YD003 RM-YD003



REF. NO.	PART NO.	DESCRIPTION	REMARK
R6246 Δ	1-219-568-91	METAL	8.2M 5% 1/2W
R6248	1-216-828-11	METAL CHIP	3.9K 5% 1/10W
R6249	1-219-759-11	METAL	1M 5% 1/2W
R6250	1-216-829-11	METAL CHIP	4.7K 5% 1/10W
R6251	1-216-828-11	METAL CHIP	3.9K 5% 1/10W
R6252	1-216-837-11	METAL CHIP	22K 5% 1/10W
R6253	1-216-833-11	METAL CHIP	10K 5% 1/10W
R6254	1-216-833-11	METAL CHIP	10K 5% 1/10W
R6255	1-216-344-00	METAL OXIDE	0.39 5% 1W
R6257	1-216-349-00	METAL OXIDE	1 5% 1W
R6259	1-244-207-11	WIREWOUND	3.3 5% 10W
R6261	1-260-328-11	CARBON	1K 5% 1/2W
R6262	1-216-829-11	METAL CHIP	4.7K 5% 1/10W
R6263	1-249-389-11	CARBON	4.7 5% 1/4W
R6267	1-216-829-11	METAL CHIP	4.7K 5% 1/10W
R6268	1-216-821-11	METAL CHIP	1K 5% 1/10W
R6273	1-249-389-11	CARBON	4.7 5% 1/4W
R6277	1-216-821-11	METAL CHIP	1K 5% 1/10W
R6278	1-216-827-11	METAL CHIP	3.3K 5% 1/10W
R6279	1-216-845-11	METAL CHIP	100K 5% 1/10W
R6280	1-216-833-11	METAL CHIP	10K 5% 1/10W
R6281	1-216-833-11	METAL CHIP	10K 5% 1/10W
R6283	1-243-979-71	METAL OXIDE	0.1 5% 2W
R6284	1-216-864-11	SHORT CHIP	0
R6285	1-216-832-11	METAL CHIP	8.2K 5% 1/10W
R6286	1-216-834-11	METAL CHIP	12K 5% 1/10W
R6287	1-218-720-11	METAL CHIP	15K 0.5% 1/10W
R6288	1-218-708-11	METAL CHIP	4.7K 0.5% 1/10W
R6291	1-216-864-11	SHORT CHIP	0
R6296	1-216-821-11	METAL CHIP	1K 5% 1/10W
R6297	1-216-801-11	METAL CHIP	22 5% 1/10W
R6300	1-216-821-11	METAL CHIP	1K 5% 1/10W
R6301	1-216-864-11	SHORT CHIP	0
R6302	1-216-845-11	METAL CHIP	100K 5% 1/10W
R6339	1-216-864-11	SHORT CHIP	0
< RELAY >			
RY6001 Δ	1-755-388-11	RELAY (AC POWER)	
RY6002 Δ	1-755-388-11	RELAY (AC POWER)	
< SPARK GAP >			
SG6000	1-576-487-11	ELEMENT, SPARK	
< TRANSFORMER >			
T6000 Δ	1-443-747-11	TRANSFORMER (PIT)	
T6004 Δ	1-443-748-11	TRANSFORMER (SRT)	
< VARISTOR >			
VD6000 Δ	1-804-992-21	VARISTOR	
VD6001 Δ	1-804-991-21	VARISTOR	
VD6003 Δ	1-804-991-21	VARISTOR	

HA MOUNT *****			
< CAPACITOR >			
C7000	1-100-597-91	CERAMIC CHIP	0.1UF 10% 25V

REF. NO.	PART NO.	DESCRIPTION	REMARK
< CONNECTOR >			
CN7000	1-819-445-11	HEADER ASSEMBLY FOR PWB 3P	
< RESISTOR >			
R7001	1-218-676-11	METAL CHIP	220 0.5% 1/10W
R7002	1-218-684-11	METAL CHIP	470 0.5% 1/10W
R7003	1-218-691-11	METAL CHIP	910 0.5% 1/10W
R7004	1-218-698-11	METAL CHIP	1.8K 0.5% 1/10W
R7005	1-218-706-11	METAL CHIP	3.9K 0.5% 1/10W
< SWITCH >			
S7000	1-692-431-21	SWITCH, TACTILE	
S7001	1-692-431-21	SWITCH, TACTILE	
S7002	1-692-431-21	SWITCH, TACTILE	
S7003	1-692-431-21	SWITCH, TACTILE	
S7004	1-692-431-21	SWITCH, TACTILE	
S7005	1-692-431-21	SWITCH, TACTILE	

HB MOUNT *****			
< CAPACITOR >			
C7020	1-164-156-11	CERAMIC CHIP	0.1UF 25V
C7021	1-126-964-11	ELECT	10UF 20% 50V
C7022	1-162-974-11	CERAMIC CHIP	0.01UF 50V
C7023	1-162-974-11	CERAMIC CHIP	0.01UF 50V
C7024	1-162-974-11	CERAMIC CHIP	0.01UF 50V
C7025	1-164-156-11	CERAMIC CHIP	0.1UF 25V
C7026	1-162-974-11	CERAMIC CHIP	0.01UF 50V
C7027	1-162-974-11	CERAMIC CHIP	0.01UF 50V
C7028	1-162-974-11	CERAMIC CHIP	0.01UF 50V
C7029	1-164-156-11	CERAMIC CHIP	0.1UF 25V
C7030	1-162-915-11	CERAMIC CHIP	10PF 0.50PF 50V
C7031	1-165-908-11	CERAMIC CHIP	1UF 10% 10V
C7032	1-162-915-11	CERAMIC CHIP	10PF 0.50PF 50V
< DIODE >			
D7022	6-500-861-01	DIODE SML-020MVT-T86	
D7023	8-719-064-07	DIODE SML-310LTT86	
D7024	6-500-861-01	DIODE SML-020MVT-T86	
< IC >			
IC7020	6-600-210-01	IC RPM7240-H8	
IC7021	6-707-223-01	IC LM75BIM-5/NOPB	
< TRANSISTOR >			
Q7020	8-729-120-28	TRANSISTOR	2SC1623-L5L6
Q7021	8-729-120-28	TRANSISTOR	2SC1623-L5L6
Q7022	8-729-120-28	TRANSISTOR	2SC1623-L5L6
Q7023	8-729-120-28	TRANSISTOR	2SC1623-L5L6
Q7024	8-729-120-28	TRANSISTOR	2SC1623-L5L6
< RESISTOR >			
R7020	1-216-823-11	METAL CHIP	1.5K 5% 1/10W
R7021	1-216-805-11	METAL CHIP	47 5% 1/10W



REF. NO.	PART NO.	DESCRIPTION	REMARK
R7022	1-216-833-11	METAL CHIP 10K	5% 1/10W
R7023	1-216-833-11	METAL CHIP 10K	5% 1/10W
R7024	1-216-813-11	METAL CHIP 220	5% 1/10W
R7025	1-216-813-11	METAL CHIP 220	5% 1/10W
R7026	1-216-833-11	METAL CHIP 10K	5% 1/10W
R7027	1-216-833-11	METAL CHIP 10K	5% 1/10W
R7028	1-216-813-11	METAL CHIP 220	5% 1/10W
R7029	1-216-833-11	METAL CHIP 10K	5% 1/10W
R7030	1-216-833-11	METAL CHIP 10K	5% 1/10W
R7031	1-216-833-11	METAL CHIP 10K	5% 1/10W
R7032	1-216-813-11	METAL CHIP 220	5% 1/10W
R7033	1-216-813-11	METAL CHIP 220	5% 1/10W
R7034	1-216-833-11	METAL CHIP 10K	5% 1/10W
R7035	1-216-833-11	METAL CHIP 10K	5% 1/10W
R7039	1-216-833-11	METAL CHIP 10K	5% 1/10W
R7046	1-216-801-11	METAL CHIP 22	5% 1/10W
R7047	1-216-801-11	METAL CHIP 22	5% 1/10W
< SWITCH >			
S7020	1-692-431-21	SWITCH, TACTILE	

HC MOUNT *****			
< CAPACITOR >			
C7101	1-162-964-11	CERAMIC CHIP 0.001UF	10% 50V
C7102	1-162-964-11	CERAMIC CHIP 0.001UF	10% 50V
C7103	1-126-964-11	ELECT 10UF	20% 50V
C7104	1-126-964-11	ELECT 10UF	20% 50V
C7111	1-162-927-11	CERAMIC CHIP 100PF	5% 50V
C7112	1-162-927-11	CERAMIC CHIP 100PF	5% 50V
C7113	1-164-227-11	CERAMIC CHIP 0.022UF	10% 25V
C7114	1-164-227-11	CERAMIC CHIP 0.022UF	10% 25V
< DIODE >			
D7100	8-719-977-28	DIODE DTZ10B	
D7101	8-719-977-28	DIODE DTZ10B	
D7102	8-719-069-55	DIODE UDZSTE-175.6B	
D7108	8-719-083-58	DIODE UDZSTE-173.9B	
D7109	8-719-062-19	DIODE MA3200WA-TX	
D7110	8-719-062-19	DIODE MA3200WA-TX	
D7111	8-719-062-19	DIODE MA3200WA-TX	
< JACK >			
J7100	1-819-355-11	PHONO JACK 3P	
J7101	1-819-356-11	PHONO JACK 3P	
J7102	1-568-267-11	JACK	
< RESISTOR >			
R7103	1-216-849-11	METAL CHIP 220K	5% 1/10W
R7104	1-216-849-11	METAL CHIP 220K	5% 1/10W
R7105	1-218-676-11	METAL CHIP 220	0.5% 1/10W
R7106	1-218-668-11	METAL CHIP 100	0.5% 1/10W
R7109	1-216-821-11	METAL CHIP 1K	5% 1/10W
R7110	1-216-821-11	METAL CHIP 1K	5% 1/10W
R7111	1-216-864-11	SHORT CHIP 0	
R7123	1-216-864-11	SHORT CHIP 0	
R7124	1-218-676-11	METAL CHIP 220	0.5% 1/10W

REF. NO.	PART NO.	DESCRIPTION	REMARK
R7125	1-218-676-11	METAL CHIP 220	0.5% 1/10W
R7126	1-216-864-11	SHORT CHIP 0	
R7128	1-216-797-11	METAL CHIP 10	5% 1/10W
R7129	1-216-797-11	METAL CHIP 10	5% 1/10W
< VARISTOR >			
VD7100	1-803-974-21	VARISTOR, CHIP (1608)	
VD7101	1-803-974-21	VARISTOR, CHIP (1608)	
VD7102	1-803-974-21	VARISTOR, CHIP (1608)	
VD7108	1-803-974-21	VARISTOR, CHIP (1608)	
VD7109	1-803-974-21	VARISTOR, CHIP (1608)	
VD7110	1-803-974-21	VARISTOR, CHIP (1608)	

HPC MOUNT *****			
< CAPACITOR >			
C7200	1-107-826-11	CERAMIC CHIP 0.1UF	10% 16V
C7201	1-127-573-11	CERAMIC CHIP 1UF	10% 16V
C7202	1-127-573-11	CERAMIC CHIP 1UF	10% 16V
C7205	1-107-826-11	CERAMIC CHIP 0.1UF	10% 16V
C7206	1-107-826-11	CERAMIC CHIP 0.1UF	10% 16V
C7207	1-107-826-11	CERAMIC CHIP 0.1UF	10% 16V
< CONNECTOR >			
CN7200	1-794-930-21	CONNECTOR, D SUB	
< DIODE >			
D7203	8-719-073-39	DIODE HZU5.6GTRF	
D7204	8-719-073-39	DIODE HZU5.6GTRF	
D7205	8-719-073-39	DIODE HZU5.6GTRF	
D7208	8-719-977-28	DIODE DTZ10B	
D7209	8-719-977-28	DIODE DTZ10B	
D7210	8-719-404-50	DIODE MA111-TX	
D7212	8-719-977-28	DIODE DTZ10B	
D7213	8-719-801-78	DIODE 1SS184	
< FERRITE BEAD >			
FB7200	1-469-100-21	FERRITE	0UH
FB7201	1-469-100-21	FERRITE	0UH
FB7202	1-469-100-21	FERRITE	0UH
FB7204	1-400-141-22	FERRITE	0UH
< IC >			
IC7200	6-704-600-01	IC M24C02-WMN6T(B)	
< JACK >			
J7200	1-573-798-11	JACK, MINIATURE (DIA. 3.5)	
< IC LINK >			
PS7200	1-576-122-21	IC LINK	0.4A 72V

HPC

K

REF. NO.	PART NO.	DESCRIPTION	REMARK	REF. NO.	PART NO.	DESCRIPTION	REMARK
		< TRANSISTOR >					
Q7200	6-550-014-01	TRANSISTOR SSM6N15FU(TE85R)		C3036	1-115-339-11	CERAMIC CHIP 0.1UF 10%	50V
		< RESISTOR >		C3037	1-164-937-11	CERAMIC CHIP 0.001UF 10%	50V
R7200	1-216-853-11	METAL CHIP 470K 5%	1/10W	C3038	1-115-339-11	CERAMIC CHIP 0.1UF 10%	50V
R7202	1-216-845-11	METAL CHIP 100K 5%	1/10W	C3039	1-115-339-11	CERAMIC CHIP 0.1UF 10%	50V
R7205	1-216-805-11	METAL CHIP 47 5%	1/10W	C3041	1-164-937-11	CERAMIC CHIP 0.001UF 10%	50V
R7206	1-216-864-11	SHORT CHIP 0		C3042	1-115-339-11	CERAMIC CHIP 0.1UF 10%	50V
R7207	1-216-864-11	SHORT CHIP 0		C3043	1-136-177-00	FILM 1UF 5%	50V
R7208	1-216-864-11	SHORT CHIP 0		C3044	1-164-937-11	CERAMIC CHIP 0.001UF 10%	50V
R7209	1-216-805-11	METAL CHIP 47 5%	1/10W	C3045	1-164-937-11	CERAMIC CHIP 0.001UF 10%	50V
R7210	1-216-851-11	METAL CHIP 330K 5%	1/10W	C3046	1-164-936-11	CERAMIC CHIP 680PF 10%	50V
R7211	1-216-851-11	METAL CHIP 330K 5%	1/10W	C3047	1-163-989-11	CERAMIC CHIP 0.033UF 10%	25V
R7216	1-216-833-11	METAL CHIP 10K 5%	1/10W	C3048	1-107-820-11	CERAMIC CHIP 0.1UF	16V
R7217	1-216-833-11	METAL CHIP 10K 5%	1/10W	C3049	1-163-989-11	CERAMIC CHIP 0.033UF 10%	25V
R7218	1-216-805-11	METAL CHIP 47 5%	1/10W	C3050	1-164-936-11	CERAMIC CHIP 680PF 10%	50V
R7219	1-216-805-11	METAL CHIP 47 5%	1/10W	C3051	1-107-820-11	CERAMIC CHIP 0.1UF	16V
R7222	1-216-864-11	SHORT CHIP 0		C3052	1-107-820-11	CERAMIC CHIP 0.1UF	16V
R7223	1-216-864-11	SHORT CHIP 0		C3053	1-164-937-11	CERAMIC CHIP 0.001UF 10%	50V
R7227	1-216-821-11	METAL CHIP 1K 5%	1/10W	C3054	1-115-339-11	CERAMIC CHIP 0.1UF 10%	50V
R7229	1-216-845-11	METAL CHIP 100K 5%	1/10W	C3055	1-115-339-11	CERAMIC CHIP 0.1UF 10%	50V
R7231	1-216-864-11	SHORT CHIP 0		C3056	1-164-937-11	CERAMIC CHIP 0.001UF 10%	50V
R7232	1-216-864-11	SHORT CHIP 0		C3057	1-115-339-11	CERAMIC CHIP 0.1UF 10%	50V
R7233	1-216-864-11	SHORT CHIP 0		C3058	1-115-339-11	CERAMIC CHIP 0.1UF 10%	50V
R7234	1-216-864-11	SHORT CHIP 0		C3059	1-115-339-11	CERAMIC CHIP 0.1UF 10%	50V
R7235	1-216-864-11	SHORT CHIP 0		C3060	1-112-030-31	ELECT 1500UF 20%	35V

A-1115-002-A K BOARD, COMPLETE							

		< CAPACITOR >		C3061	1-128-992-21	ELECT CHIP 47UF 20%	25V
C3001	1-107-820-11	CERAMIC CHIP 0.1UF	16V	C3062	1-164-937-11	CERAMIC CHIP 0.001UF 10%	50V
C3002	1-162-964-11	CERAMIC CHIP 0.001UF 10%	50V	C3063	1-164-937-11	CERAMIC CHIP 0.001UF 10%	50V
C3003	1-128-404-11	ELECT CHIP 100UF 20%	35V	C3065	1-136-177-00	FILM 1UF 5%	50V
C3004	1-117-681-11	ELECT CHIP 100UF 20%	16V	C3067	1-107-820-11	CERAMIC CHIP 0.1UF	16V
C3005	1-107-820-11	CERAMIC CHIP 0.1UF	16V	C3068	1-128-992-21	ELECT CHIP 47UF 20%	25V
C3006	1-164-506-11	CERAMIC CHIP 4.7UF	16V	C3070	1-115-339-11	CERAMIC CHIP 0.1UF 10%	50V
C3007	1-107-820-11	CERAMIC CHIP 0.1UF	16V	C3071	1-136-177-00	FILM 1UF 5%	50V
C3008	1-117-681-11	ELECT CHIP 100UF 20%	16V	C3072	1-128-995-21	ELECT CHIP 100UF 20%	10V
C3009	1-126-206-11	ELECT CHIP 100UF 20%	6.3V	C3073	1-164-936-11	CERAMIC CHIP 680PF 10%	50V
C3010	1-107-820-11	CERAMIC CHIP 0.1UF	16V	C3074	1-163-989-11	CERAMIC CHIP 0.033UF 10%	25V
C3011	1-164-506-11	CERAMIC CHIP 4.7UF	16V	C3075	1-126-395-11	ELECT CHIP 22UF 20%	16V
C3012	1-164-506-11	CERAMIC CHIP 4.7UF	16V	C3076	1-164-360-11	CERAMIC CHIP 0.1UF	16V
C3013	1-107-820-11	CERAMIC CHIP 0.1UF	16V	C3077	1-165-128-11	CERAMIC CHIP 0.22UF	16V
C3019	1-117-681-11	ELECT CHIP 100UF 20%	16V	C3078	1-165-128-11	CERAMIC CHIP 0.22UF	16V
C3020	1-107-820-11	CERAMIC CHIP 0.1UF	16V	C3079	1-100-567-81	CERAMIC CHIP 10000PF 10%	25V
C3021	1-165-128-11	CERAMIC CHIP 0.22UF	16V	C3080	1-128-993-21	ELECT CHIP 22UF 20%	10V
C3022	1-107-820-11	CERAMIC CHIP 0.1UF	16V	C3081	1-107-820-11	CERAMIC CHIP 0.1UF	16V
C3023	1-165-128-11	CERAMIC CHIP 0.22UF	16V	C3082	1-107-820-11	CERAMIC CHIP 0.1UF	16V
C3024	1-163-989-11	CERAMIC CHIP 0.033UF 10%	25V	C3083	1-107-820-11	CERAMIC CHIP 0.1UF	16V
C3025	1-164-936-11	CERAMIC CHIP 680PF 10%	50V	C3084	1-100-567-81	CERAMIC CHIP 10000PF 10%	25V
C3026	1-115-339-11	CERAMIC CHIP 0.1UF 10%	50V	C3085	1-128-995-21	ELECT CHIP 100UF 20%	10V
C3027	1-112-030-31	ELECT 1500UF 20%	35V	C3086	1-164-850-11	CERAMIC CHIP 10PF 0.50PF	50V
C3028	1-128-992-21	ELECT CHIP 47UF 20%	25V	C3088	1-100-567-81	CERAMIC CHIP 10000PF 10%	25V
C3030	1-136-177-00	FILM 1UF 5%	50V	C3090	1-164-937-11	CERAMIC CHIP 0.001UF 10%	50V
C3032	1-107-820-11	CERAMIC CHIP 0.1UF	16V	C3091	1-164-850-11	CERAMIC CHIP 10PF 0.50PF	50V
C3033	1-128-992-21	ELECT CHIP 47UF 20%	25V	C3094	1-164-936-11	CERAMIC CHIP 680PF 10%	50V
C3034	1-164-937-11	CERAMIC CHIP 0.001UF 10%	50V	C3095	1-164-936-11	CERAMIC CHIP 680PF 10%	50V
C3035	1-115-339-11	CERAMIC CHIP 0.1UF 10%	50V	C3096	1-164-936-11	CERAMIC CHIP 680PF 10%	50V
		< CONNECTOR >		C3097	1-164-936-11	CERAMIC CHIP 680PF 10%	50V
CN3001	1-794-502-11	PIN, CONNECTOR (B04B-PASK) 4P		C3099	1-165-128-11	CERAMIC CHIP 0.22UF	16V

K

REF. NO.	PART NO.	DESCRIPTION	REMARK	REF. NO.	PART NO.	DESCRIPTION	REMARK
CN3002	1-819-443-11	HEADER ASSEMBLY FOR PWB 15P		R3014	1-218-965-11	RES-CHIP 10K	5% 1/16W
CN3003	1-580-838-11	PIN, CONNECTOR (PC BOARD) 4P		R3015	1-218-941-81	RES-CHIP 100	5% 1/16W
		< DIODE >		R3016	1-218-965-11	RES-CHIP 10K	5% 1/16W
D3001	6-500-260-01	DIODE P6SMB39AT3		R3017	1-218-965-11	RES-CHIP 10K	5% 1/16W
D3002	6-500-260-01	DIODE P6SMB39AT3		R3019	1-218-977-11	RES-CHIP 100K	5% 1/16W
D3003	6-500-260-01	DIODE P6SMB39AT3		R3020	1-218-965-11	RES-CHIP 10K	5% 1/16W
D3004	6-500-260-01	DIODE P6SMB39AT3		R3021	1-218-978-11	RES-CHIP 120K	5% 1/16W
		< TERMINAL BOARD >		R3022	1-218-977-11	RES-CHIP 100K	5% 1/16W
EB3001	1-537-771-21	TERMINAL BOARD, GROUND		R3023	1-218-990-81	SHORT CHIP 0	
EB3002	1-537-771-21	TERMINAL BOARD, GROUND		R3024	1-218-965-11	RES-CHIP 10K	5% 1/16W
		< FILTER >		R3025	1-208-695-11	METAL CHIP 3.3K	0.5% 1/16W
FL3001	1-234-177-21	FERRITE OUH		R3026	1-208-695-11	METAL CHIP 3.3K	0.5% 1/16W
FL3002	1-234-177-21	FERRITE OUH		R3027	1-218-965-11	RES-CHIP 10K	5% 1/16W
		< IC >		R3029	1-218-977-11	RES-CHIP 100K	5% 1/16W
IC3001	6-706-862-01	IC NJM2387DL2-TE1		R3030	1-208-683-11	METAL CHIP 1K	0.5% 1/16W
IC3002	8-759-548-99	IC SN74LV08APWR		R3032	1-218-933-11	RES-CHIP 22	5% 1/16W
IC3003	6-706-862-01	IC NJM2387DL2-TE1		R3033	1-218-990-81	SHORT CHIP 0	
IC3004	8-759-573-97	IC SN74LVC541APWR		R3034	1-218-965-11	RES-CHIP 10K	5% 1/16W
IC3005	6-707-629-01	IC CXD9845M		R3035	1-218-977-11	RES-CHIP 100K	5% 1/16W
IC3006	6-705-979-01	IC CXD9788AR		R3036	1-218-990-81	SHORT CHIP 0	
IC3007	6-701-189-01	IC MC74VHC1GU04DFT1		R3037	1-218-990-81	SHORT CHIP 0	
IC3008	6-700-263-01	IC NJM2870F18(TE2)		R3038	1-218-978-11	RES-CHIP 120K	5% 1/16W
		< COIL >		R3039	1-218-977-11	RES-CHIP 100K	5% 1/16W
L3001	1-457-106-11	COIL,CHOKE 10UH		R3040	1-218-990-81	SHORT CHIP 0	
L3002	1-457-106-11	COIL,CHOKE 10UH		R3041	1-218-990-81	SHORT CHIP 0	
L3006	1-412-939-11	INDUCTOR 1UH		R3042	1-218-990-81	SHORT CHIP 0	
		< IC LINK >		R3043	1-218-990-81	SHORT CHIP 0	
PS3001	1-576-788-21	FUSE 5A 72V		R3044	1-218-965-11	RES-CHIP 10K	5% 1/16W
		< TRANSISTOR >		R3045	1-218-990-81	SHORT CHIP 0	
Q3002	8-729-602-36	TRANSISTOR 2SA1602-F		R3046	1-218-965-11	RES-CHIP 10K	5% 1/16W
Q3003	8-729-602-36	TRANSISTOR 2SA1602-F		R3047	1-218-990-81	SHORT CHIP 0	
Q3004	8-729-120-28	TRANSISTOR 2SC1623-L5L6		R3048	1-218-990-81	SHORT CHIP 0	
Q3005	8-729-602-36	TRANSISTOR 2SA1602-F		R3049	1-218-990-81	SHORT CHIP 0	
Q3006	8-729-602-36	TRANSISTOR 2SA1602-F		R3050	1-216-791-11	METAL CHIP 3.3	5% 1/10W
		< RESISTOR >		R3051	1-218-941-81	RES-CHIP 100	5% 1/16W
R3001	1-218-990-81	SHORT CHIP 0		R3052	1-218-941-81	RES-CHIP 100	5% 1/16W
R3002	1-218-965-11	RES-CHIP 10K	5% 1/16W	R3053	1-216-791-11	METAL CHIP 3.3	5% 1/10W
R3003	1-218-990-81	SHORT CHIP 0		R3054	1-218-941-81	RES-CHIP 100	5% 1/16W
R3004	1-218-990-81	SHORT CHIP 0		R3055	1-218-965-11	RES-CHIP 10K	5% 1/16W
R3005	1-218-990-81	SHORT CHIP 0		R3056	1-216-800-11	METAL CHIP 18	5% 1/10W
R3006	1-208-927-11	METAL CHIP 47K	0.5% 1/16W	R3057	1-218-941-81	RES-CHIP 100	5% 1/16W
R3007	1-208-929-11	METAL CHIP 56K	0.5% 1/16W	R3059	1-218-941-81	RES-CHIP 100	5% 1/16W
R3008	1-208-931-11	METAL CHIP 68K	0.5% 1/16W	R3060	1-218-990-81	SHORT CHIP 0	
R3009	1-208-699-11	METAL CHIP 4.7K	0.5% 1/16W	R3062	1-216-790-11	METAL CHIP 2.7	5% 1/10W
R3010	1-208-699-11	METAL CHIP 4.7K	0.5% 1/16W	R3063	1-216-790-11	METAL CHIP 2.7	5% 1/10W
R3011	1-218-990-81	SHORT CHIP 0		R3064	1-218-941-81	RES-CHIP 100	5% 1/16W
R3012	1-218-941-81	RES-CHIP 100	5% 1/16W	R3065	1-218-965-11	RES-CHIP 10K	5% 1/16W
R3013	1-218-941-81	RES-CHIP 100	5% 1/16W	R3066	1-218-990-81	SHORT CHIP 0	
				R3067	1-218-990-81	SHORT CHIP 0	
				R3070	1-218-945-11	RES-CHIP 220	5% 1/16W
				R3071	1-218-941-81	RES-CHIP 100	5% 1/16W
				R3072	1-218-990-81	SHORT CHIP 0	
				R3073	1-218-990-81	SHORT CHIP 0	
				R3075	1-218-945-11	RES-CHIP 220	5% 1/16W
				R3076	1-218-972-11	RES-CHIP 39K	5% 1/16W
				R3077	1-216-800-11	METAL CHIP 18	5% 1/10W
				R3078	1-218-941-81	RES-CHIP 100	5% 1/16W
				R3079	1-218-945-11	RES-CHIP 220	5% 1/16W
				R3082	1-218-990-81	SHORT CHIP 0	
				R3084	1-218-965-11	RES-CHIP 10K	5% 1/16W
				R3085	1-216-800-11	METAL CHIP 18	5% 1/10W
				R3086	1-218-933-11	RES-CHIP 22	5% 1/16W
				R3088	1-218-933-11	RES-CHIP 22	5% 1/16W



REF. NO.	PART NO.	DESCRIPTION	REMARK	REF. NO.	PART NO.	DESCRIPTION	REMARK
R3089	1-218-990-81	SHORT CHIP	0	C7824	1-107-826-11	CERAMIC CHIP	0.1UF 10% 16V
R3092	1-218-990-81	SHORT CHIP	0	C7825	1-128-996-11	ELECT CHIP	4.7UF 20% 50V
R3096	1-216-790-11	METAL CHIP	2.7	5%	1/10W		
R3097	1-216-790-11	METAL CHIP	2.7	5%	1/10W		
R3098	1-218-990-81	SHORT CHIP	0	C7826	1-165-319-11	CERAMIC CHIP	0.1UF 50V
R3100	1-216-800-11	METAL CHIP	18	5%	1/10W		
R3101	1-216-791-11	METAL CHIP	3.3	5%	1/10W		
R3102	1-216-791-11	METAL CHIP	3.3	5%	1/10W		
R3103	1-216-791-11	METAL CHIP	3.3	5%	1/10W		
R3104	1-218-945-11	RES-CHIP	220	5%	1/16W		
R3105	1-218-977-11	RES-CHIP	100K	5%	1/16W		
R3106	1-218-990-81	SHORT CHIP	0	C7827	1-128-996-11	ELECT CHIP	4.7UF 20% 50V
R3107	1-218-989-11	RES-CHIP	1M	5%	1/16W		
R3108	1-218-941-81	RES-CHIP	100	5%	1/16W		
R3111	1-218-945-11	RES-CHIP	220	5%	1/16W		
R3112	1-218-945-11	RES-CHIP	220	5%	1/16W		
R3113	1-218-990-81	SHORT CHIP	0	C7828	1-162-964-11	CERAMIC CHIP	0.001UF 10% 50V
R3114	1-218-990-81	SHORT CHIP	0	C7829	1-162-970-11	CERAMIC CHIP	0.01UF 10% 25V
R3150	1-216-295-91	SHORT CHIP	0	C7830	1-164-156-11	CERAMIC CHIP	0.1UF 25V
R3151	1-216-813-11	METAL CHIP	220	5%	1/10W		
R3152	1-216-864-11	SHORT CHIP	0	C7831	1-162-964-11	CERAMIC CHIP	0.001UF 10% 50V
R3153	1-216-864-11	SHORT CHIP	0	C7832	1-162-970-11	CERAMIC CHIP	0.01UF 10% 25V
R3154	1-216-864-11	SHORT CHIP	0	C7834	1-137-765-21	ELECT CHIP	47UF 20% 16V
R3155	1-216-864-11	SHORT CHIP	0	C7835	1-128-996-11	ELECT CHIP	4.7UF 20% 50V
R3156	1-216-864-11	SHORT CHIP	0	C7836	1-128-396-11	ELECT CHIP	470UF 20% 10V
R3157	1-216-864-11	SHORT CHIP	0	C7837	1-164-156-11	CERAMIC CHIP	0.1UF 25V
R3158	1-216-864-11	SHORT CHIP	0	C7838	1-164-156-11	CERAMIC CHIP	0.1UF 25V
R3159	1-216-864-11	SHORT CHIP	0	C7840	1-165-989-11	CERAMIC CHIP	10UF 10% 6.3V
R3164	1-218-990-81	SHORT CHIP	0	C7841	1-165-989-11	CERAMIC CHIP	10UF 10% 6.3V
		< VIBRATOR >		C7842	1-162-970-11	CERAMIC CHIP	0.01UF 10% 25V
X3001	1-795-660-21	QUARTZ CRYSTAL UNIT		C7843	1-162-970-11	CERAMIC CHIP	0.01UF 10% 25V
*****				C7845	1-164-156-11	CERAMIC CHIP	0.1UF 25V
		A-1103-580-A QT BOARD, COMPLETE		C7846	1-165-492-21	ELECT CHIP	100UF 20% 10V
		*****		C7847	1-128-396-11	ELECT CHIP	470UF 20% 10V
		< CAPACITOR >		C7849	1-165-492-21	ELECT CHIP	100UF 20% 10V
C7800	1-137-765-21	ELECT CHIP	47UF	20%	16V		
C7801	1-165-492-21	ELECT CHIP	100UF	20%	10V		
C7802	1-165-492-21	ELECT CHIP	100UF	20%	10V		
C7803	1-165-492-21	ELECT CHIP	100UF	20%	10V		
C7804	1-100-159-91	CERAMIC CHIP	22UF	10%	6.3V		
C7805	1-107-826-11	CERAMIC CHIP	0.1UF	10%	16V		
C7806	1-115-156-11	CERAMIC CHIP	1UF		10V		
C7807	1-127-820-11	CERAMIC CHIP	4.7UF	10%	16V		
C7808	1-127-820-11	CERAMIC CHIP	4.7UF	10%	16V		
C7809	1-137-765-21	ELECT CHIP	47UF	20%	16V		
C7810	1-127-820-11	CERAMIC CHIP	4.7UF	10%	16V		
C7811	1-162-995-11	CERAMIC CHIP	0.022UF		50V		
C7812	1-162-970-11	CERAMIC CHIP	0.01UF	10%	25V		
C7813	1-107-826-11	CERAMIC CHIP	0.1UF	10%	16V		
C7814	1-107-826-11	CERAMIC CHIP	0.1UF	10%	16V		
C7815	1-107-826-11	CERAMIC CHIP	0.1UF	10%	16V		
C7816	1-162-995-11	CERAMIC CHIP	0.022UF		50V		
C7817	1-115-566-11	CERAMIC CHIP	4.7UF	10%	10V		
C7818	1-127-820-11	CERAMIC CHIP	4.7UF	10%	16V		
C7819	1-100-159-91	CERAMIC CHIP	22UF	10%	6.3V		
C7820	1-107-826-11	CERAMIC CHIP	0.1UF	10%	16V		
C7821	1-107-826-11	CERAMIC CHIP	0.1UF	10%	16V		
C7823	1-100-159-91	CERAMIC CHIP	22UF	10%	6.3V		
		< CONNECTOR >		C7905	1-164-156-11	CERAMIC CHIP	0.1UF 25V
CN7802	1-819-390-21	FFC/FPC CONNECTOR (ZIF) 49P		C7906	1-164-156-11	CERAMIC CHIP	0.1UF 25V
CN7903	1-818-484-11	FFC/FPC CONNECTOR (ZIF) 80P		C7907	1-164-156-11	CERAMIC CHIP	0.1UF 25V
				C7908	1-164-156-11	CERAMIC CHIP	0.1UF 25V
				C7912	1-164-156-11	CERAMIC CHIP	0.1UF 25V
				C7929	1-115-156-11	CERAMIC CHIP	1UF 10V
				C7931	1-164-156-11	CERAMIC CHIP	0.1UF 25V
				C7932	1-164-156-11	CERAMIC CHIP	0.1UF 25V
				C7933	1-164-156-11	CERAMIC CHIP	0.1UF 25V
				C7934	1-164-156-11	CERAMIC CHIP	0.1UF 25V
				C7935	1-115-156-11	CERAMIC CHIP	1UF 10V
				C7943	1-164-156-11	CERAMIC CHIP	0.1UF 25V
				C7944	1-164-156-11	CERAMIC CHIP	0.1UF 25V
				C7945	1-162-917-11	CERAMIC CHIP	15PF 5% 50V
				C7946	1-162-964-11	CERAMIC CHIP	0.001UF 10% 50V
				C7947	1-162-964-11	CERAMIC CHIP	0.001UF 10% 50V
				C7948	1-162-964-11	CERAMIC CHIP	0.001UF 10% 50V
				C7949	1-162-964-11	CERAMIC CHIP	0.001UF 10% 50V
				C7950	1-162-964-11	CERAMIC CHIP	0.001UF 10% 50V

QT

REF. NO.	PART NO.	DESCRIPTION	REMARK	REF. NO.	PART NO.	DESCRIPTION	REMARK
		< DIODE >		R7803	1-216-809-11	METAL CHIP	100 5% 1/10W
D7801	8-719-066-99	DIODE SML-210VTT86		R7804	1-216-821-11	METAL CHIP	1K 5% 1/10W
D7802	8-719-060-99	DIODE SML-210MT-T86		R7805	1-218-847-11	METAL CHIP	1K 0.5% 1/10W
D7803	8-719-066-99	DIODE SML-210VTT86		R7806	1-211-977-11	METAL CHIP	22 0.5% 1/10W
		< FERRITE BEAD >		R7807	1-218-830-11	METAL CHIP	200 0.5% 1/10W
FB7800	1-400-180-21	INDUCTOR 0UH		R7808	1-216-845-11	METAL CHIP	100K 5% 1/10W
FB7801	1-400-089-21	FERRITE 0UH		R7809	1-216-833-11	METAL CHIP	10K 5% 1/10W
FB7802	1-400-089-21	FERRITE 0UH		R7810	1-216-864-11	SHORT CHIP	0
FB7803	1-400-180-21	INDUCTOR 0UH		R7815	1-216-833-11	METAL CHIP	10K 5% 1/10W
FB7808	1-400-180-21	INDUCTOR 0UH		R7816	1-216-864-11	SHORT CHIP	0
FB7809	1-414-226-21	FERRITE 0UH		R7817	1-216-864-11	SHORT CHIP	0
FB7810	1-414-226-21	FERRITE 0UH		R7818	1-216-864-11	SHORT CHIP	0
FB7811	1-414-760-21	FERRITE 0UH		R7819	1-216-837-11	METAL CHIP	22K 5% 1/10W
FB7901	1-414-229-11	FERRITE 0UH		R7820	1-216-833-11	METAL CHIP	10K 5% 1/10W
FB7902	1-414-760-21	FERRITE 0UH		R7821	1-216-833-11	METAL CHIP	10K 5% 1/10W
FB7903	1-414-760-21	FERRITE 0UH		R7822	1-216-837-11	METAL CHIP	22K 5% 1/10W
FB7904	1-414-229-11	FERRITE 0UH		R7825	1-216-864-11	SHORT CHIP	0
FB7905	1-414-229-11	FERRITE 0UH		R7831	1-218-889-11	METAL CHIP	56K 0.5% 1/10W
FB7906	1-414-229-11	FERRITE 0UH		R7832	1-218-881-11	METAL CHIP	27K 0.5% 1/10W
		< IC >		R7833	1-216-864-11	SHORT CHIP	0
IC7800	6-708-112-01	IC MIC49300WR-TR		R7835	1-216-864-11	SHORT CHIP	0
IC7801	6-705-839-01	IC XC6219B182MR		R7839	1-216-864-11	SHORT CHIP	0
IC7802	6-708-082-01	IC NJM2846DL2-05(TE2)		R7841	1-216-833-11	METAL CHIP	10K 5% 1/10W
IC7803	6-708-171-01	IC MIC5235YM5TR		R7842	1-216-864-11	SHORT CHIP	0
IC7804	8-749-925-00	IC TK11819MTL		R7844	1-216-809-11	METAL CHIP	100 5% 1/10W
IC7806	8-759-646-63	IC CD74HC4053M-96		R7845	1-216-821-11	METAL CHIP	1K 5% 1/10W
IC7807	8-759-549-01	IC SN74LV125APWR		R7850	1-216-817-11	METAL CHIP	470 5% 1/10W
IC7808	6-708-082-01	IC NJM2846DL2-05(TE2)		R7851	1-216-835-11	METAL CHIP	15K 5% 1/10W
IC7900	8-753-238-09	IC CXD1969R-T6		R7852	1-216-817-11	METAL CHIP	470 5% 1/10W
IC7904	8-759-649-45	IC SN74AHC1G04DCKR		R7853	1-216-837-11	METAL CHIP	22K 5% 1/10W
IC7906	6-706-811-01	IC TPS2091DR		R7854	1-216-864-11	SHORT CHIP	0
IC7907	6-706-812-01	IC TPS2012ADR		R7858	1-216-809-11	METAL CHIP	100 5% 1/10W
		< COIL >		R7859	1-216-833-11	METAL CHIP	10K 5% 1/10W
L7800	1-414-755-11	INDUCTOR 22UH		R7860	1-216-837-11	METAL CHIP	22K 5% 1/10W
L7801	1-412-642-61	INDUCTOR 1.2MH		R7861	1-216-833-11	METAL CHIP	10K 5% 1/10W
L7802	1-414-755-11	INDUCTOR 22UH		R7863	1-216-837-11	METAL CHIP	22K 5% 1/10W
L7804	1-414-754-11	INDUCTOR 10UH		R7864	1-216-833-11	METAL CHIP	10K 5% 1/10W
L7805	1-414-752-11	INDUCTOR 2.2UH		R7865	1-216-833-11	METAL CHIP	10K 5% 1/10W
L7806	1-414-754-11	INDUCTOR 10UH		R7866	1-216-827-11	METAL CHIP	3.3K 5% 1/10W
L7808	1-414-754-11	INDUCTOR 10UH		R7867	1-216-817-11	METAL CHIP	470 5% 1/10W
L7809	1-414-754-11	INDUCTOR 10UH		R7877	1-216-864-11	SHORT CHIP	0
L7810	1-414-754-11	INDUCTOR 10UH		R7878	1-216-864-11	SHORT CHIP	0
L7811	1-414-754-11	INDUCTOR 10UH		R7883	1-216-864-11	SHORT CHIP	0
L7812	1-414-754-11	INDUCTOR 10UH		R7885	1-216-864-11	SHORT CHIP	0
		< TRANSISTOR >		R7886	1-216-864-11	SHORT CHIP	0
Q7802	8-729-047-14	TRANSISTOR 2SC3775		R7888	1-216-803-11	METAL CHIP	33 5% 1/10W
Q7803	8-729-120-28	TRANSISTOR 2SC1623-L5L6		R7890	1-216-295-91	SHORT CHIP	0
Q7804	8-729-120-28	TRANSISTOR 2SC1623-L5L6		R7891	1-218-867-11	METAL CHIP	6.8K 0.5% 1/10W
Q7805	8-729-120-28	TRANSISTOR 2SC1623-L5L6		R7892	1-218-891-11	METAL CHIP	68K 0.5% 1/10W
Q7806	8-729-600-22	TRANSISTOR 2SA1235-F		R7893	1-218-911-11	METAL CHIP	470K 0.5% 1/10W
Q7807	8-729-120-28	TRANSISTOR 2SC1623-L5L6		R7894	1-216-833-11	METAL CHIP	10K 5% 1/10W
		< RESISTOR >		R7896	1-216-295-91	SHORT CHIP	0
R7800	1-216-864-11	SHORT CHIP 0		R7897	1-216-295-91	SHORT CHIP	0
				R7909	1-216-864-11	SHORT CHIP	0
				R7910	1-216-797-11	METAL CHIP	10 5% 1/10W
				R7911	1-216-797-11	METAL CHIP	10 5% 1/10W
				R7912	1-216-803-11	METAL CHIP	33 5% 1/10W
				R7913	1-216-797-11	METAL CHIP	10 5% 1/10W
				R7914	1-216-797-11	METAL CHIP	10 5% 1/10W
				R7915	1-216-797-11	METAL CHIP	10 5% 1/10W
				R7919	1-216-821-11	METAL CHIP	1K 5% 1/10W
				R7940	1-216-833-11	METAL CHIP	10K 5% 1/10W
				R7941	1-216-833-11	METAL CHIP	10K 5% 1/10W
				R7952	1-216-833-11	METAL CHIP	10K 5% 1/10W

Les composants identifiés par une trame et une marque Δ sont critiques pour la sécurité. Ne les remplacer que par une pièce portant le numéro spécifié.

The components identified by shading and mark Δ are critical for safety. Replace only with part number specified.

KDF-E42A10/E50A10

RM-YD003 RM-YD003

QT **QU** **S2** **T1** **T2**

REF. NO.	PART NO.	DESCRIPTION	REMARK
R7954	1-216-845-11	METAL CHIP 100K	5% 1/10W
R7987	1-216-833-11	METAL CHIP 10K	5% 1/10W
R7989	1-216-845-11	METAL CHIP 100K	5% 1/10W
R7991	1-216-864-11	SHORT CHIP	0
R7992	1-216-864-11	SHORT CHIP	0
R7994	1-216-864-11	SHORT CHIP	0
R7997	1-216-833-11	METAL CHIP 10K	5% 1/10W
R7998	1-216-833-11	METAL CHIP 10K	5% 1/10W
R8000	1-216-829-11	METAL CHIP 4.7K	5% 1/10W
R8002	1-216-864-11	SHORT CHIP	0
< NETWORK RESISTOR >			
RB7900	1-234-371-21	RES, NETWORK 47	(1005X4)
RB7901	1-234-371-21	RES, NETWORK 47	(1005X4)
RB7902	1-242-963-21	RES, NETWORK 33	(1005X4)
RB7903	1-234-369-21	RES, NETWORK 10	(1005X4)
RB7904	1-234-369-21	RES, NETWORK 10	(1005X4)
RB7905	1-234-369-21	RES, NETWORK 10	(1005X4)
RB7906	1-234-369-21	RES, NETWORK 10	(1005X4)
RB7907	1-234-369-21	RES, NETWORK 10	(1005X4)
RB7908	1-234-369-21	RES, NETWORK 10	(1005X4)
RB7909	1-234-369-21	RES, NETWORK 10	(1005X4)
RB7910	1-234-369-21	RES, NETWORK 10	(1005X4)
RB7911	1-234-369-21	RES, NETWORK 10	(1005X4)
RB7913	1-234-400-21	CONDUCTOR, NETWORK	(2010X4)
RB7914	1-242-963-21	RES, NETWORK 33	(1005X4)
RB7916	1-234-400-21	CONDUCTOR, NETWORK	(2010X4)
RB7917	1-234-400-21	CONDUCTOR, NETWORK	(2010X4)
< TUNER >			
TU7800	8-597-505-00	TUNER UNIT, DIGITAL BTD-CA811Z	

* A-1073-391-A QU BOARD, COMPLETE *****			
< CAPACITOR >			
C7951	1-115-156-11	CERAMIC CHIP 1UF	10V
C7952	1-115-156-11	CERAMIC CHIP 1UF	10V
C7953	1-164-156-11	CERAMIC CHIP 0.1UF	25V
C7954	1-164-156-11	CERAMIC CHIP 0.1UF	25V
< CONNECTOR >			
CN7951	1-573-768-21	PIN, CONNECTOR (1.5MM) (SMD)5P	
CN7952	1-818-486-11	PCMCIA CONNECTOR (SMD)	
CN7953	1-818-483-11	FFC/FPC CONNECTOR (ZIF) 80P	
< TEST POINT >			
TP7950	1-694-766-21	TERMINAL (ONBOARD CONTACT)	

S2 MOUNT *****			
< CAPACITOR >			
C7180	1-164-156-11	CERAMIC CHIP 0.1UF	25V
C7181	1-165-908-11	CERAMIC CHIP 1UF	10% 10V

REF. NO.	PART NO.	DESCRIPTION	REMARK
C7182	1-162-915-11	CERAMIC CHIP 10PF	0.50PF 50V
C7183	1-162-915-11	CERAMIC CHIP 10PF	0.50PF 50V
< CONNECTOR >			
CN7180	1-819-333-11	HEADER ASSEMBLY FOR PWB 5P	
< IC >			
IC7180	6-707-223-01	IC LM75BIM-5/NOPB	
< RESISTOR >			
R7181	1-216-801-11	METAL CHIP 22	5% 1/10W
R7182	1-216-801-11	METAL CHIP 22	5% 1/10W
R7185	1-216-864-11	SHORT CHIP	0
R7186	1-216-864-11	SHORT CHIP	0
R7187	1-216-864-11	SHORT CHIP	0

T1 MOUNT *****			
< CONNECTOR >			
CN7150	1-819-336-11	HEADER ASSEMBLY FOR PWB 3P	
< SWITCH >			
S7150	1-786-591-11	SWITCH, MICRO	

T2 MOUNT *****			
< SWITCH >			
S7155	1-786-591-11	SWITCH, MICRO	

MISCELLANEOUS *****			
A-1054-757-A CONVERTER, PS A-1123-069-A OPTICS UNIT BLOCK ASSY (E50A10) A-1123-071-A OPTICS UNIT BLOCK ASSY (E42A10) A-1124-850-A LAMP BLOCK ASSY			
Δ 1-468-936-11 POWER SUPPLY BLOCK			
1-576-912-11 THERMOSTAT			
Δ 1-787-231-11 D.C. FAN (SIROCCO)			
Δ 1-787-333-11 D.C. FAN			
Δ 1-787-373-11 FAN,DC			
Δ 1-791-192-21 CORD, NOISE FILTER WITH POWER			
1-826-219-11 LOUDSPEAKER (5X15cm)			
1-830-099-21 LEAD WIRE WITH CONNECTOR(LVDS)			

ACCESSORIES & PACKING MATERIALS *****			
2-597-544-11 MANUAL, INSTRUCTION			

<u>REF. NO.</u>	<u>PART NO.</u>	<u>DESCRIPTION</u>	<u>REMARK</u>
	2-597-544-21	MANUAL, INSTRUCTION	
	2-597-544-31	MANUAL, INSTRUCTION	
	2-597-545-11	QUICK SETUP GUIDE	
	2-597-545-21	QUICK SETUP GUIDE	
	2-597-545-31	QUICK SETUP GUIDE	
		< REMOTE COMMANDER >	
	1-479-327-11	REMOTE COMANDER RM-YD003	
	9-885-083-75	COVER, BATTERY	
	9-885-089-78	COVER, SLIDE	
		< OPTIONAL ACCESSORIES >	
	93-0875-00	LAMP XL-2400	

SONY[®]

2-597-544-11(1)

GRAND WEGA[™]

LCD Projection TV
HD-TV
Operating Instructions

KDF-E42A10
KDF-E50A10



Owner's Record

The model and serial numbers are located at the rear of the TV. Record these numbers in the spaces provided below. Refer to them whenever you call upon your Sony dealer regarding this product.

Model No. _____

Serial No. _____

Contacting Sony

If, after reading the following instructions, you have additional questions related to the use of your Sony® TV, please call one of the following numbers.

Customers in the continental United States contact the Direct Response Center at:

1-800-222-SONY (7669)

or visit <http://www.sonystyle.com/tv/>

Customers in Canada contact the Customer Relations Center at:

1-877-899-SONY (7669)

or visit <http://www.sonystyle.ca/tv/>

WARNING

To reduce the risk of fire or electric shock, do not expose this apparatus to rain or moisture.

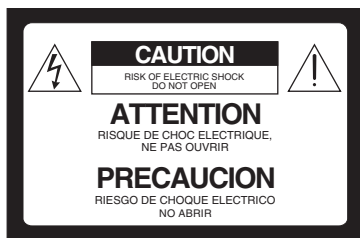

This symbol is intended to alert the user to the presence of uninsulated “dangerous voltage” within the product’s enclosure that may be of sufficient magnitude to constitute a risk of electric shock to persons.



This symbol is intended to alert the user to the presence of important operating and maintenance (servicing) instructions in the literature accompanying the appliance.

The apparatus shall not be exposed to dripping or splashing and no objects filled with liquids, such as vases, shall be placed on the apparatus.

CAUTION

To prevent electric shock, do not use this polarized AC plug with an extension cord, receptacle or other outlet unless the blades can be fully inserted to prevent blade exposure.

CAUTION

When using TV games, computers, and similar products with your projection TV, keep the brightness and contrast functions at low settings. If a fixed (non-moving) pattern is left on the screen for long periods of time at a high brightness or contrast setting, the image can be permanently imprinted onto the screen. Continuously watching the same program can cause the imprint of station logos onto the TV screen. These types of imprints are not covered by your warranty because they are the result of misuse.

Note on Caption Vision

This TV provides display of TV closed captioning in accordance with §15.119 of the FCC rules.

For Customers in the United States

If you have any questions about this product, you may call; Sony Customer Information Services Center 1-800-222-7669 or <http://www.sony.com/>

Declaration of Conformity

Trade Name: SONY
Model: KDF-E42A10/KDF-E50A10
Responsible Party: Sony Electronics Inc.
Address: 16450 W. Bernardo Dr,
San Diego, CA 92127 U.S.A.
Telephone Number: 858-942-2230

This device complies with part 15 of the FCC rules. Operation is subject to the following two conditions: (1) This device may not cause harmful interference, and (2) this device must accept any interference received, including interference that may cause undesired operation.

NOTIFICATION

This equipment has been tested and found to comply with the limits for a Class B digital device, pursuant to Part 15 of the FCC Rules. These limits are designed to provide reasonable protection against harmful interference in a residential installation. This equipment generates, uses and can radiate radio frequency energy and, if not installed and used in accordance with the instructions, may cause harmful interference to radio communications. However, there is no guarantee that interference will not occur in a particular installation. If this equipment does cause harmful interference to radio or television reception, which can be determined by turning the equipment off and on, the user is encouraged to try to correct the interference by one or more of the following measures:

- Reorient or relocate the receiving antenna.
- Increase the separation between the equipment and receiver.
- Connect the equipment into an outlet on a circuit different from that to which the receiver is connected.
- Consult the dealer or an experienced radio/TV technician for help.

You are cautioned that any changes or modifications not expressly approved in this manual could void your authority to operate this equipment.

For Customers in Canada

This Class B digital apparatus complies with Canadian ICES-003.

Safety

- Operate the TV only on 120 V AC.
- Use the AC power cord specified by Sony and suitable for the voltage where you use it.
- The plug is designed, for safety purposes, to fit into the wall outlet only one way. If you are unable to insert the plug fully into the outlet, contact your dealer.
- If any liquid or solid object should fall inside the cabinet, unplug the TV immediately and have it checked by qualified service personnel before operating it further.
- If you will not be using the TV for several days, disconnect the power by pulling the plug itself. Never pull on the cord.
- For details concerning safety precautions, see “Important Safety Instructions” on page 5.

Installing

- The TV should be installed near an easily accessible power outlet.
- To prevent internal heat buildup, do not block the ventilation openings.
- Do not install the TV in a hot or humid place, or in a place subject to excessive dust or mechanical vibration.
- Avoid operating the TV at temperatures below 41°F (5°C).
- If the TV is transported directly from a cold to a warm location, or if the room temperature changes suddenly, the picture may be blurred or show poor color due to moisture condensation. In this case, please wait a few hours to let the moisture evaporate before turning on the TV.

(Continued)

- To obtain the best picture, do not expose the screen to direct illumination or direct sunlight. It is recommended to use spot lighting directed down from the ceiling or to cover the windows that face the screen with opaque drapery. It is desirable to install the TV in a room where the floor and walls are not of a reflective material.
- See pages 13 and 14 for more information on the installation.

HDMI This TV incorporates High-Definition Multimedia Interface (HDMI™) technology. HDMI, the HDMI logo and High-Definition Multimedia Interface are trademarks or registered trademarks of HDMI Licensing LLC.

CAUTION

Use the following Sony appliance(s) only with the following TV STAND.

Use with other TV STAND may cause instability and possibly result in injury.

SONY APPLIANCE MODEL NO.

KDF-E42A10

KDF-E50A10

SONY TV STAND MODEL NO.

SU-RG11S (KDF-E42A10)

SU-RG11M (KDF-E50A10)

To Customers

Sufficient expertise is required for installing the specified product. Be sure to subcontract the installation to Sony dealers or licensed contractors and pay adequate attention to safety during the installation.

For Customers in the United States

This product contains mercury. Disposal of this product may be regulated if sold in the United States. For disposal or recycling information, please contact your local authorities or the Electronics Industries Alliance (<http://www.eiae.org>).

Note

This digital television is capable of receiving analog basic, digital basic and digital premium cable television programming by direct connection to a cable system providing such programming. A security card provided by your cable operator is required to view encrypted digital programming. Certain advanced and interactive digital cable services such as video-on-demand, a cable operator's enhanced program guide and data-enhanced television services may require the use of a set-top box. For more information call your local cable operator.

This television also includes a QAM demodulator which should allow you to receive unscrambled digital cable television programming via subscription service to a cable service provider. Availability of digital cable television programming in your area depends on the type of programming and signal provided by your cable service provider.

Trademark Information

CableCARD™ is a trademark of Cable Television Laboratories, Inc.

TruSurround XT, SRS and the (●)* symbol are trademarks of SRS Labs, Inc. TruSurround XT technology is incorporated under license from SRS Labs, Inc.

Licensed by BBE Sound, Inc. under USP4638258, 4482866. "BBE" and BBE symbol are trademarks of BBE Sound, Inc.

Macintosh is a trademark licensed to Apple Computer, Inc., registered in the U.S.A and other countries.

WEGA, Grand WEGA, WEGA GATE, Steady Sound, Digital Reality Creation and CineMotion are registered trademarks of Sony Corporation.

"PlayStation" is a trademark of Sony Computer Entertainment, Inc.



This TV is manufactured under license from Dolby Laboratories. "Dolby" and the double-D symbol are trademarks of Dolby Laboratories.

Important Safety Instructions

- 1) Read these instructions.
- 2) Keep these instructions.
- 3) Heed all warnings.
- 4) Follow all instructions.
- 5) Do not use this apparatus near water.



- 6) Clean only with dry cloth.



- 7) Do not block any ventilation openings. Install in accordance with the manufacturer's instructions.

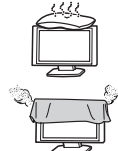

- 8) Do not install near any heat sources such as radiators, heat registers, stoves, or other apparatus (including amplifiers) that produce heat.



- 9) Do not defeat the safety purpose of the polarized or grounding-type plug. A polarized plug has two blades with one wider than the other. A grounding type plug has two blades and a third grounding prong. The wide blade or the third prong are provided for your safety. If the provided plug does not fit into your outlet, consult an electrician for replacement of the obsolete outlet.



- 10) Protect the power cord from being walked on or pinched particularly at plugs, convenience receptacles, and the point where they exit from the apparatus.



- 11) Only use attachments/accessories specified by the manufacturer.



- 12) Use only with the cart, stand, tripod, bracket, or table specified by the manufacturer, or sold with the apparatus. When a cart is used, use caution when moving the cart/apparatus combination to avoid injury from tip-over.



- 13) Unplug this apparatus during lightning storms or when unused for long periods of time.



- 14) Refer all servicing to qualified service personnel. Servicing is required when the apparatus has been damaged in any way, such as power-supply cord or plug is damaged, liquid has been spilled or objects have fallen into the apparatus, the apparatus has been exposed to rain or moisture, does not operate normally, or has been dropped.



- Be sure to observe the TV's "For Safety" section on page 6.

Antennas

Outdoor Antenna Grounding

If an outdoor antenna is installed, follow the precautions below. An outdoor antenna system should not be located in the vicinity of overhead power lines or other electric light or power circuits, or where it can come in contact with such power lines or circuits.

WHEN INSTALLING AN OUTDOOR ANTENNA SYSTEM, EXTREME CARE SHOULD BE TAKEN TO KEEP FROM CONTACTING SUCH POWER LINES OR CIRCUITS AS CONTACT WITH THEM IS ALMOST INVARIABLY FATAL.

Be sure the antenna system is grounded so as to provide some protection against voltage surges and built-up static charges.

Section 810 of the National Electrical Code (NEC) in USA and Section 54 of the Canadian Electrical Code in Canada provides information with respect to proper grounding of the mast and supporting structure, grounding of the lead-in wire to an antenna discharge unit, size of grounding conductors, location of antenna discharge unit, connection to grounding electrodes, and requirements for the grounding electrode.

(Continued)

Antenna Grounding According to the NEC

Refer to section 54-300 of Canadian Electrical Code for Antenna Grounding.

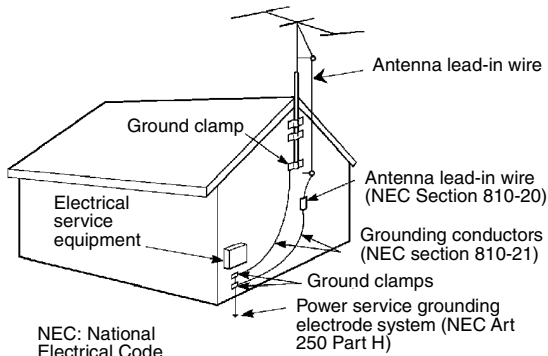

Cleaning

- Clean the rear cover area of the TV regularly. Dust in the rear cover area may cause a problem with the cooling system of the TV set.
- Clean the cabinet of the TV with a dry soft cloth. To remove dust from the screen, wipe it gently with a soft cloth. Stubborn stains may be removed with a cloth slightly dampened with solution of mild soap and warm water. Never use strong solvents such as thinner or benzine for cleaning. If the picture becomes dark after using the TV for a long period of time, it may be necessary to clean the inside of the TV. Consult qualified service personnel.
- Unplug the AC power cord when cleaning this unit. Cleaning this unit with a plugged AC power cord may result in electric shock.



On Contamination on the Screen Surface

The screen surface has a special coating to reduce reflections. To prevent screen damage, clean the screen as follows:

- Clean the screen with a soft cloth.
- To remove hard contamination, use a cloth moistened with a solution of mild detergent and water. Do not spray cleaning solution directly onto the TV. It should only be sprayed to moisten the cleaning cloth.
- Do not use any type of abrasive pad, alkaline cleaner, acid cleaner, scouring powder, chemical cloth, or solvent such as alcohol, benzene or thinner, as these may scratch the screen's coating.

Service

Damage Requiring Service

Do not attempt to service the set by yourself since opening the cabinet may expose you to dangerous voltage or other hazards.

Unplug the set from the wall outlet and refer servicing to qualified service personnel.



Replacement Parts

When replacement parts are required, be sure the service technician certifies in writing that he has used replacement parts specified by the manufacturer that have the same characteristics as the original parts.

Unauthorized substitutions may result in fire, electric shock or other hazards.

See "Replacing the Lamp" on page 86.

For Safety

Be Careful When Moving the TV

When you place the TV in position, be careful not to drop it on your foot or fingers.

Watch your footing while installing the TV.

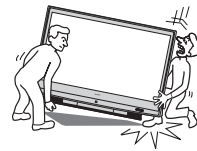

Carry the TV in the Specified Manner

If you carry the TV in a manner other than the specified manner and without the specified number of persons, it may drop and a serious injury may be caused. Be sure to follow the instructions mentioned below.

- Carry the TV with the specified number of persons (see page 13).
- Hold the TV tightly when carrying it.
- Before carrying the TV, disconnect any accessories or cables.

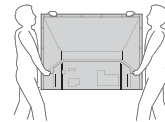

About the TV

Although the TV is made with high-precision technology, black dots may appear or bright points of light (red, blue, or green) may appear constantly on the screen. This is a structural property of the panel and is not a defect.

Installation

- If direct sunlight or other strong illumination shines on the screen, part of the screen may appear white due to reflections from behind the screen. This is a structural property of the TV. Do not expose the screen to direct illumination or direct sunlight.
- The picture quality may be affected by your viewing position. For the best picture quality, install your TV according to "Recommended Viewing Area" on page 14.
- When installing your TV against a wall, keep it at least 4 inches (10 cm) away from the wall.

Projection Lamp

- Your TV uses a projection lamp as its light source. It is time to replace the lamp with a new one (not supplied) when:
 - the lamp replacement indicator on the front panel blinks in red,
 - screen images become dark,
 - no image appears on the display after prolonged use.
- In rare instances, the bulb may pop inside the lamp unit, but the lamp unit is designed to contain all of broken glass pieces inside the lamp unit. (See "Replacing the Lamp" on page 86.)
- When the lamp eventually burns out, you may hear a noticeable pop sound. This is normal and is inherent in this type of lamp.

Disposal of Used Batteries

To preserve our environment, dispose of used batteries according to your local laws or regulations.

Cooling Fan

This TV uses a cooling fan. You may hear the noise of fan running, depending on the placement of your TV. The noise may be more noticeable during the night or when the background noise level is low.

Contents

Introducing the TV

Welcome	9
Package Contents.....	9
Features.....	9
Enjoying Your TV	11
Notes on the TV.....	11
Screen.....	11
Indicators.....	12
Projection Lamp.....	12
Installing the TV	13
Carrying Your TV.....	13
Take Precaution during Installation.....	13
Preventing the TV from Toppling Over.....	14
When Installing Your TV against a Wall.....	14
Recommended Viewing Area.....	14
TV Controls and Connectors	15
Front Panel.....	15
Side Panel.....	16
Rear Panel.....	17

Connecting the TV

Overview	19
Making Video and Audio Connections.....	19
About Using S VIDEO.....	20
About Using HDMI to DVI Adapter.....	20
Basic Connections	21
Cable System or VHF/UHF.....	22
Cable Box and Antenna.....	23
Cable Box.....	24
Satellite Receiver.....	25
Digital Cable Box or Digital Satellite Receiver.....	26
Equipment with HDMI Connection.....	27
Equipment with DVI Connection.....	28
Equipment with Digital Audio (Optical).....	29
Using CableCARD Device	30
About Using CableCARD Device.....	30
Activating CableCARD Service.....	30
Removing the CableCARD Device.....	31
Setting Up the Channel List	32
Using Initial Setup.....	32

Connecting Optional Equipment	33
VCR and Cable.....	34
VCR and Cable Box.....	35
Two VCRs for Tape Editing.....	37
DVD Player with Component Video Connectors.....	38
DVD Player with S VIDEO and Audio Connectors.....	39
Personal Computer.....	40
Camcorder or “PlayStation”.....	41
Audio Receiver.....	42

Watching the TV

Overview	43
Inserting Batteries into the Remote Control	43
Button Descriptions	44
Programming the Remote Control	47
Using Other Equipment with Your Remote Control	49
Special Buttons on the Remote Control	51
Using the GUIDE Button.....	51
Using the WIDE Button.....	53
Using the JUMP Button.....	54
Using the FREEZE Button.....	54

Introducing WEGA GATE

Overview of WEGA GATE	55
Navigating and Selecting Items	57
Using Favorites in WEGA GATE	57
Using Cable in WEGA GATE	58
Using Antenna in WEGA GATE	58
Using External Inputs in WEGA GATE	59
Using Settings in WEGA GATE	59

Using the Settings

Overview	61
Accessing the Video Settings	63
Selecting Video Options.....	63
Selecting PC Video Options.....	65
Accessing the Audio Settings	66
Selecting Audio Options.....	66
Selecting PC Audio Options.....	68

Accessing the Screen Settings	69
Selecting Screen Options	69
Selecting PC Screen Options	71
Accessing the Channel Settings	72
Selecting Channel Options	72
Accessing the Parental Lock Settings.....	74
Selecting Parental Lock Options	74
Viewing Blocked Programs	75
Selecting Custom Rating Options	76
Accessing the Setup Settings	78
Selecting Setup Options	78
Programming Caption Vision	80
Selecting PC Setup Options	81
Accessing the Applications Settings.....	83
Selecting Applications Options	83

Other Information

Overview.....	85
Contacting Sony	85
Replacing the Lamp.....	86
How to Replace the Lamp.....	86
Troubleshooting	90
Remote Control.....	90
CableCARD Device	90
Video.....	91
Audio.....	92
Channels.....	92
General	93
Specifications	94

Index

Index	96
--------------------	-----------

Introducing the TV

Welcome

Thank you for purchasing this Sony's *HD* LCD projection TV. This manual is for models KDF-E42A10 and KDF-E50A10.

Package Contents

Along with your new TV, the packing box contains a remote control and two AA (R6) batteries. See page 95 for the complete list of packaging contents.

Features

Some of the features that you will enjoy with your new TV include:

- ❑ **WEGA GATE™:** WEGA GATE is a new feature that allows you to easily navigate to the most convenient TV functions: favorite channels, cable channels, antenna channels, external input list or settings.
- ❑ **WEGA Engine:** Delivers superb picture quality from any video source by minimizing the signal deterioration caused by digital-to-analog conversion and stabilizing the signal processing. This engine features unique Sony technology, including:
 - **DRC® (Digital Reality Creation)-MF V1:** Unlike conventional line doublers, the DRC Multifunction feature replaces the signal's NTSC waveform with the near-HD equivalent by digital mapping processing. The DRC Palette option lets you customize the level of detail (Reality) and smoothness (Clarity) to create up to three custom palettes.
- ❑ **Integrated HDTV:** You can watch digital television programs and enjoy the improved audio/video quality offered by these programs.
- ❑ **Wide Screen Mode:** Allows you to watch 4:3 normal broadcasts in wide screen mode (16:9 aspect ratio).
- ❑ **Advanced Iris:** This advanced iris shutter works automatically open and close according to the incoming signal level to create brighter whites and better contrast in dark scenes.
- ❑ **CineMotion®:** Using the reverse 3-2 pull down technology, the CineMotion feature provides smoother picture movement when playing back movies or other video sources on film.
- ❑ **Parental Control:** V-Chip technology allows parents to block unsuitable programming from younger viewers.
- ❑ **CableCARD™ slot:** Provides cable subscribers with access to digitally encrypted cable channels — without the need for a set-top box — that will enable you to receive not only standard definition but also high definition television. The CableCARD device, which is provided by your cable TV company, is inserted into the TV's rear panel

(Continued)

CableCARD slot. After the service is activated with your cable TV company, the card replaces the need for a separate set-top box. (Check with your cable TV company about CableCARD service details, limitations, pricing, and availability. For more information about the CableCARD device in this manual, see page 30.)

- ❑ **Component Video Inputs:** Offers the best video quality for DVD (480p, 480i) and digital set-top box (1080i, 720p, 480p, 480i) connections.
- ❑ **S VIDEO Inputs:** Provides a high-quality image from connected equipment.
- ❑ **Favorite Channels:** With the WEGA GATE function, it allows you to navigate a list of up to 16 favorite channels without leaving the current channel.
- ❑ **Steady Sound[®]:** Equalizes volume levels so there is consistent output between programs and commercials.
- ❑ **HDMI (High-Definition Multimedia Interface):** Provides an uncompressed, all-digital audio/video interface between this TV and any HDMI-equipped audio/video component, such as a set-top box, DVD player, and A/V receiver. HDMI supports enhanced, or high-definition video, plus two-channel digital audio.

Enjoying Your TV

To enjoy your TV for years to come and maintain its original picture quality, you should perform periodic maintenance.

Notes on the TV

To enjoy clear picture

- Prevent sunlight or other light sources from shining directly on to the screen.
- The screen surface is easily scratched. Do not rub, touch, or tap it with sharp or abrasive objects (see “On Contamination on the Screen Surface” on page 6).

When not using the TV for a long period of time

- Unplug the AC power cord from the outlet if you anticipate not using the TV for more than a week.

When turning off the power

- The cooling fan will continue to operate for about two minutes. Allow several minutes before unplugging from the outlet or switching the breaker off.

On moisture condensation

- If your TV is moved directly from a cold to a warm location or is placed in a humid room, or if the room temperature changes suddenly, the picture may blur or show poor color. This is caused by moisture condensation on the lenses inside. Wait a few hours to let the moisture evaporate before turning on the TV. When the condensation has evaporated, the picture will return to normal.

Screen

To minimize reflection, the screen surface has a special coating. Inappropriate cleaning methods could damage the screen surface. Special care is required.

Cleaning the Screen Surface

Dust and dirt on the screen can affect the picture quality. To dust off the screen use a soft cloth. Be sure to follow the cleaning instruction on page 6 for stubborn stains and dirt.

Indicators

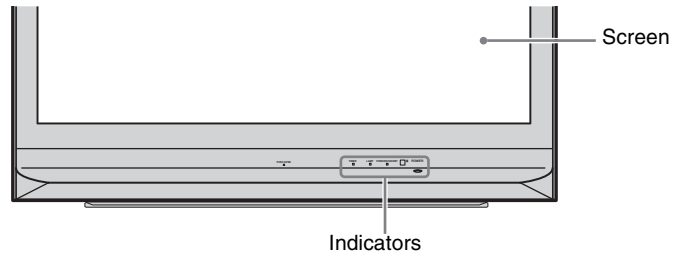

The indicators show the current status of your TV. If there is a change in the condition or a problem with the TV, the indicators will flash or light up in the manner described below to let you know that it requires your attention.

<i>Indicator</i>	<i>Flashing because...</i>
POWER/ STANDBY flashing	green : The lamp for the light source is preparing to turn on. When it is ready, it turns on. red : The lamp door or the lamp is not securely attached. The red indicator will continue to flash in intervals of three blinks at a time until the lamp door or the lamp is placed correctly. When the lamp door or the lamp is securely attached, the TV will turn on with green indicator.
LAMP indicator flashes	The projection lamp has burned out. Replace it with new one (see page 86).
TIMER indicator is lit	When one of the timers is set, the indicator will remain lit (will not flash) even when the TV is turned off.

Projection Lamp

How to replace the lamp, see page 86.

Your TV uses a projection lamp as its light source. As with any lamp, it has lifespan and needs to be replaced when the Lamp indicator flashes or the screen becomes darker. Note the following:

- After turning on your TV, it may take a while (1 minute or less) before the picture appears.
- When the projection lamp wears out, the screen goes dark. Replace the lamp with a new Sony XL-2400 replacement lamp (not supplied).

 **The light emitted from the lamp is quite bright when your TV is in use. To avoid eye discomfort or injury, do not look into the light housing when the power is on.**

Installing the TV

Carrying Your TV

Carrying the TV requires at least two people. Do not hold by the pedestal or the front panel of the TV. Doing so may cause these parts to break off.

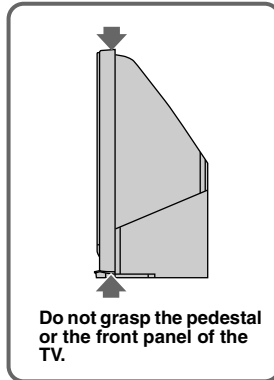

When moving the TV, place one hand in the hole on the lower portion of the TV while grasping the top with the other hand, as shown in the illustration below.

KDF-E42A10

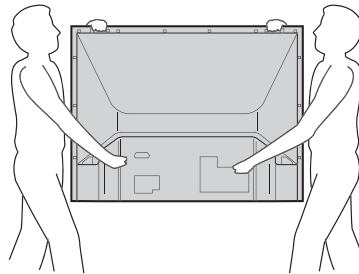

KDF-E50A10

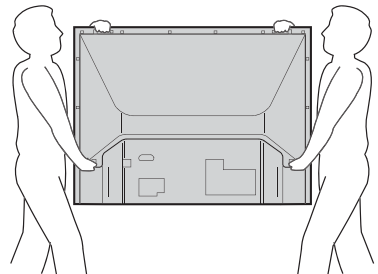

If you have connected cables and cords, be sure to unplug them before moving the TV.

Take Precaution during Installation

To ensure the safety of children and the TV, keep children away from the TV during installation. Climbing on or pushing the TV or its stand may cause it to fall and damage the TV.

Preventing the TV from Toppling Over

As a protective measure, secure the TV as follows.

Using the TV stand with support belts

- ❑ Sony strongly recommends using the TV stand SU-RG11S (for KDF-E42A10)/SU-RG11M (for KDF-E50A10) with a support belt designed for your TV.

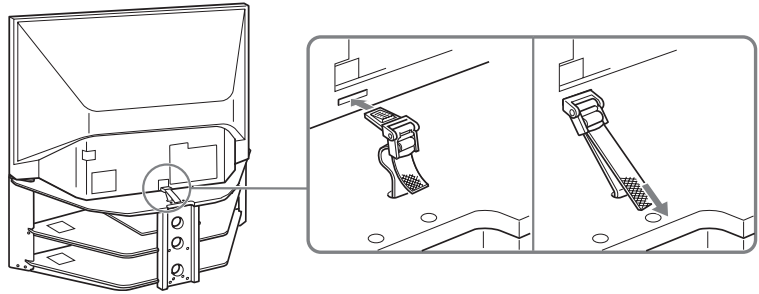

When using the SU-RG11S (for KDF-E42A10)/SU-RG11M (for KDF-E50A10) stand for your TV, you must use the support belt.

When Installing Your TV against a Wall

Keep your TV at least 4 inches (10 cm) away from the wall to provide proper ventilation.

Recommended Viewing Area

Your viewing position may affect the picture quality.

For the best picture quality, install your TV within the areas shown below.

Model

KDF-E42A10

KDF-E50A10

Viewing distance

min. 5.9 ft. (approx. 1.8 m)

min. 6.6 ft. (approx. 2.0 m)

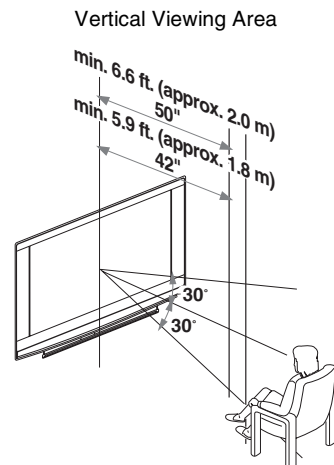
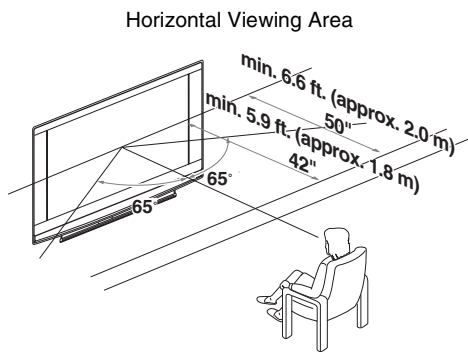

TV Controls and Connectors

Front Panel

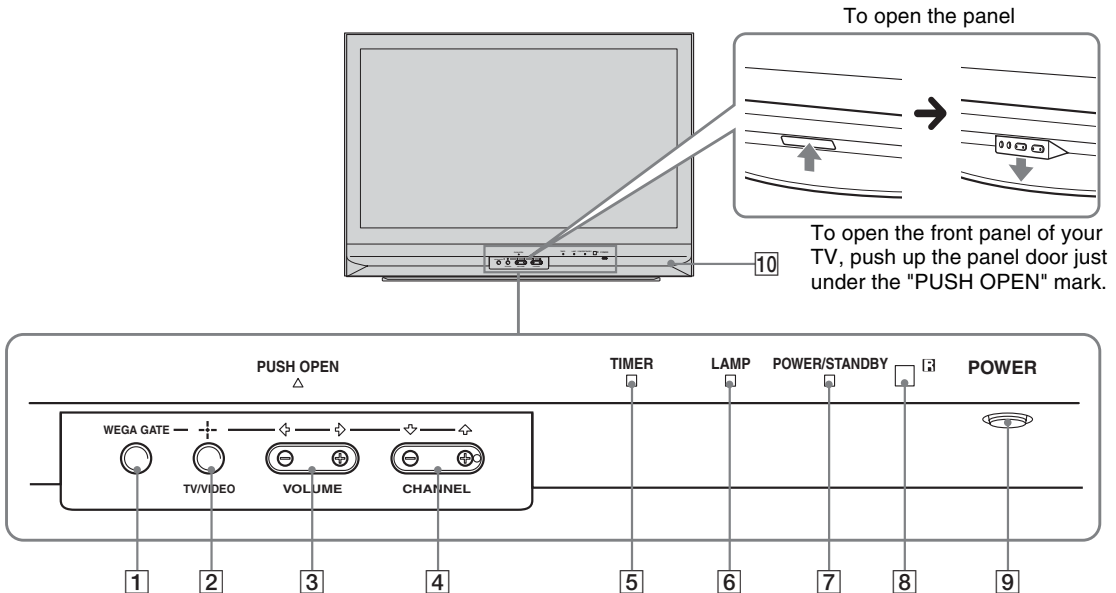

Introducing the TV

Item	Description
1	WEGA GATE Press to display WEGA GATE and activate the \leftarrow , \rightarrow , \downarrow , and \uparrow buttons. Press again to exit WEGA GATE and activate the TV/VIDEO, - VOLUME + and - CHANNEL+ buttons.
2	\leftarrow TV/VIDEO Press to confirm the selection or setting. Press repeatedly to cycle through the video equipment connected to the TV's video inputs.
3	\leftarrow - VOLUME + \rightarrow Press to adjust the volume.
4	\downarrow - CHANNEL + \uparrow Press to scan through channels. To scan quickly through channels, press and hold either - or +.
5	TIMER LED When lit, indicates one of the timers or Sleep is set. When it is set, this LED will remain lit even if the TV is turned off. For details, see page 83.
6	LAMP LED Lights up in red when the lamp for the light source has burned out. For details, see "Replacing the Lamp" on page 86.
7	POWER/STANDBY LED Lights up in green when the TV is turned on. If the LED blinks in red continuously, this may indicate the display unit needs servicing (see "Contacting Sony" on page 2). When the red LED blinks only three times, the lamp door of the lamp unit or the lamp itself is not securely attached (see page 88).
8	(IR) Infrared Receiver Receives IR signals from the remote control. Do not put anything near the sensor, as its function may be affected.
9	POWER Press to turn on and off the TV.
10	Speaker Outputs audio signal.

The CHANNEL + button has a tactile dot. Use the tactile dot as a reference when operating the TV.

Side Panel

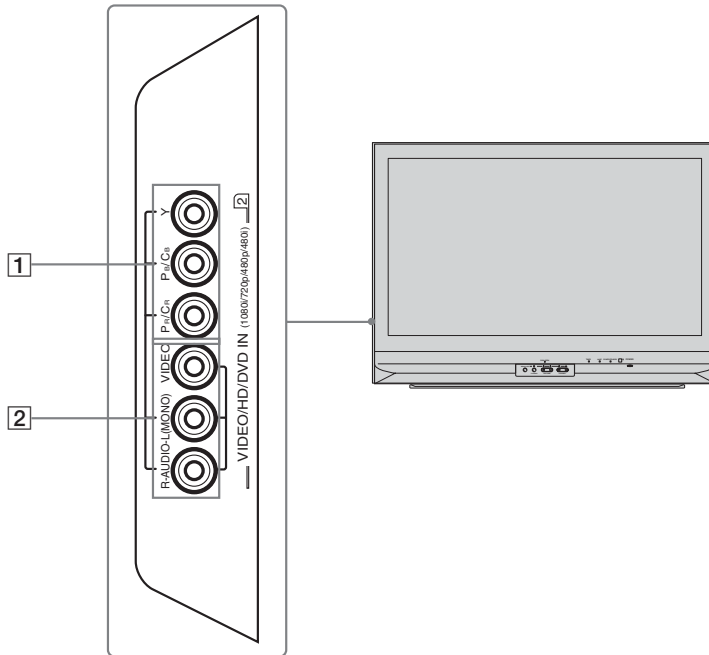

Jack	Description
1 HD/DVD IN 2 (1080i/720p/480p/480i)	Connect to your DVD player's or digital set-top box's component video (YPbPr) and audio (L/R) jacks. Component video provides better picture quality than the S VIDEO (5) of rear panel) or the composite video (6) of rear panel) connections (see page 18).
2 VIDEO IN 2 VIDEO/ AUDIO L (MONO)/ AUDIO R	Connect to the composite video and audio output jacks on your camcorder or other video equipment. When Auto is selected for the Video 2 (Component) option in the Setup (MONO)/ AUDIO R settings, the component video function will be preferentially activated (see page 79).

Rear Panel

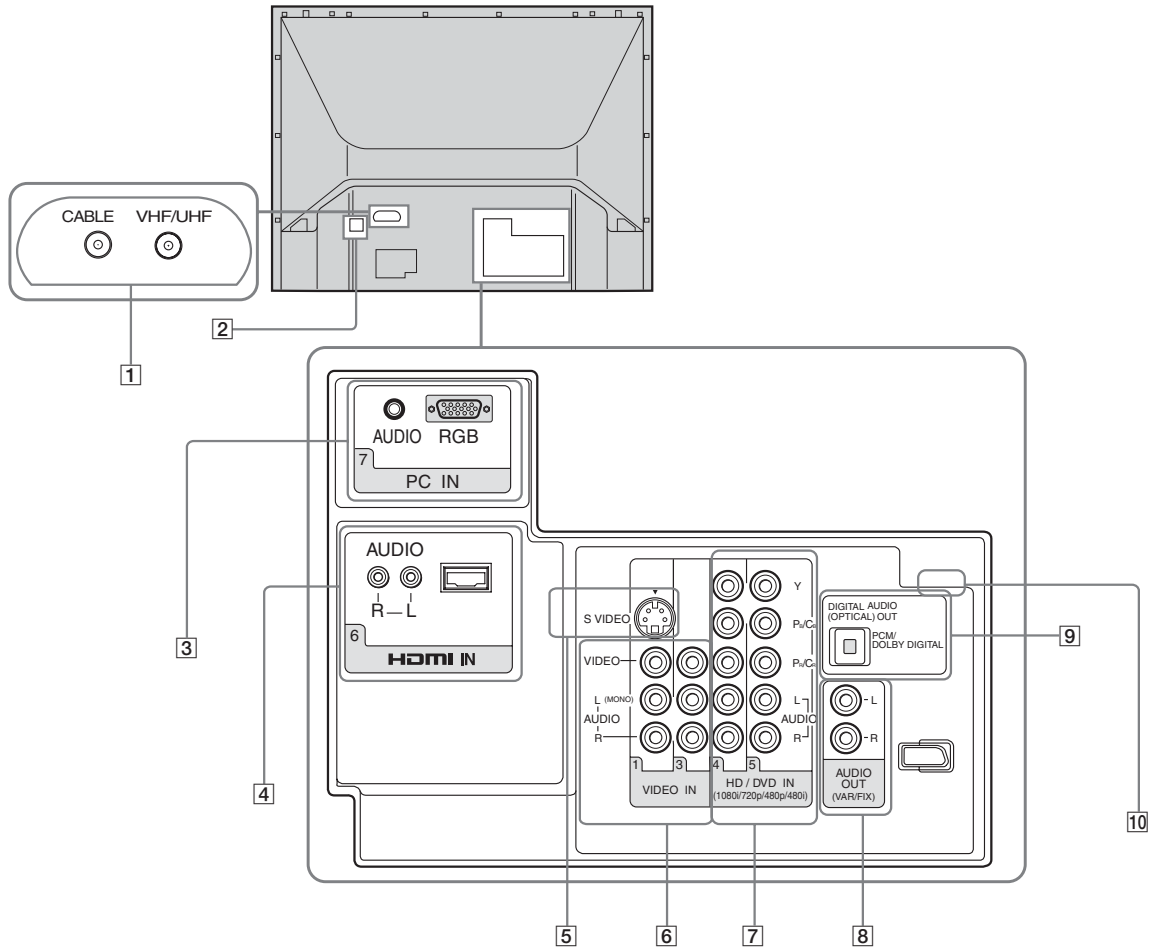

Jack	Description
1 CABLE VHF/UHF	RF input that connects to your cable and VHF/UHF antenna signal.
2 CableCARD slot	CableCARD device provides cable subscribers with access to secure, digitally encrypted cable channels — without the need for a set-top box — that will enable you to receive not only standard definition but also high definition television. For more information, see page 30.
3 PC IN 7	Connect to the video output connector and audio output jack on your personal computer. For details, see page 40.
4 HDMI IN 6 HDMI/ L-AUDIO-R	HDMI (High-Definition Multimedia Interface) provides an uncompressed, all-digital audio/video interface between this TV and any HDMI-equipped audio/video component, such as a set-top box, DVD player, and A/V receiver. HDMI supports enhanced, or high-definition video, plus two-channel digital audio. You can also connect a DVI-equipped device to your TV by using an HDMI-to-DVI cable.

(Continued)

Introducing the TV

Jack	Description
5 VIDEO IN 1 S VIDEO	Connects to the S VIDEO output jack of your VCR or other video equipment that has S VIDEO. S VIDEO provides better picture quality than the composite video (6).
6 VIDEO IN 1/3 VIDEO/ L-AUDIO-R	Connect to the composite video and audio output jacks on your VCR or other video component. A third composite video and audio (VIDEO 2) is located on the left side panel of the TV.
7 HD/DVD IN 4/5 (1080i/720p/ 480p/480i)/ L-AUDIO-R	Connect to your DVD player's or digital set-top box's component video (YPbPr) and audio (L/R) jacks. Component video provides better picture quality than the S VIDEO (5) or the composite video (6) connections.
8 AUDIO OUT (VAR/FIX) L/R	Connect to the left and right audio input jacks of your audio or video equipment. You can use these outputs to listen to your TV's audio through your stereo system.
9 DIGITAL AUDIO (OPTICAL) OUT (PCM/DOLBY* DIGITAL)	Connects to the optical audio input of a digital audio component that is PCM/Dolby Digital compatible.
10 AC IN	Connects the supplied AC power cord.

* Manufactured under license from Dolby Laboratories. "Dolby" and the double-D symbol are trademarks of Dolby Laboratories.

Connecting the TV

Overview

Your new LCD projection TV can receive both analog and digital broadcasting signals from antenna, satellite and cable TV.





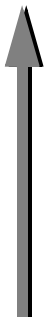

To display clear crisp pictures, you must connect your TV correctly and choose the correct display format (see “Using the WIDE Button” on page 53). It is strongly recommended to connect the antenna using a 75-ohm coaxial cable to receive optimum picture quality signal. A 300-ohm twin lead cable can be easily affected by radio noise and the like, resulting in signal deterioration. If you use a 300-ohm twin lead cable, keep it as far away as possible from the TV.

Making Video and Audio Connections

The signals that enter your TV and connected devices will need to output in the correct format using the suitable connections. Below are different types of video connectors available these days. Your TV comes with all types of connectors with the exception of the DVI connector but your cable box or satellite receiver may be equipped with this type. When connecting your TV, use the inputs that are available on your devices that provide the best video performance, as described below.

Best Video Performance



	Connector type	Separate audio connection required
	HDMI (High-Definition Multimedia Interface)	No
	DVI (Digital Video Interface) *	Yes 
	Component video (480i/480p/720p/1080i)	
	S VIDEO	
	Composite video	
	RF/Coaxial	No

* An adapter is necessary when you are connecting a DVI-equipped device to this TV (see page 20).

About Using S VIDEO



If the optional equipment you are connecting has an S VIDEO jack (shown at left), you can use an S VIDEO cable for improved picture quality (compared to an A/V cable). Because S VIDEO carries only the video signal, you also need to connect audio cables for sound, as shown below.

Example of an S VIDEO Connection

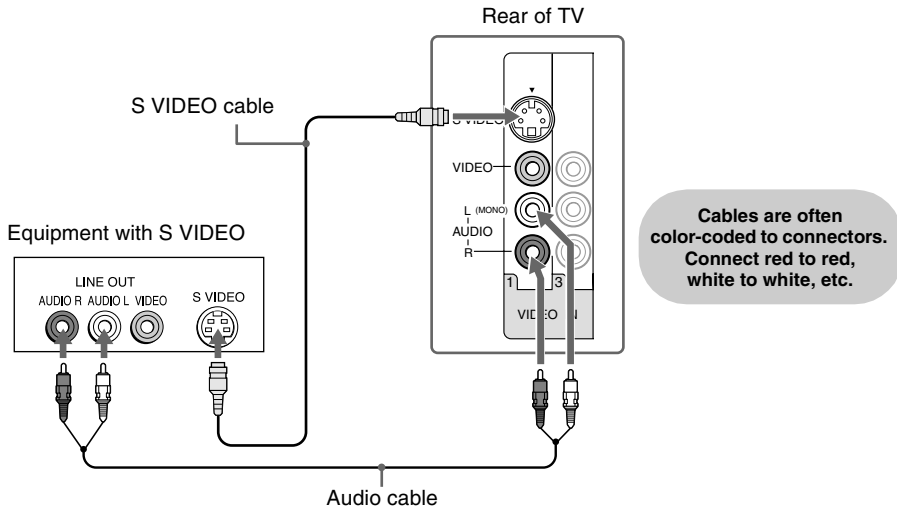

About Using HDMI to DVI Adapter

If you are connecting equipment with DVI connector with this TV, you will need to use an adapter. You can use an HDMI-to-DVI cable or an HDMI adapter (not supplied). Both are available from your local electronics store. When you use the adapter, you will also need to use separate audio cables for sound as DVI connector is for video signals only.

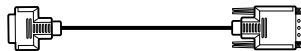

HDMI-to-DVI Cable



HDMI adapter

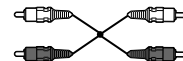

Audio cable

Basic Connections

The way in which you connect your TV will vary, depending on how your home receives a signal (antenna and satellite; cable and cable box) and whether or not you plan to connect a VCR.

<i>If You Are Connecting</i>	<i>See Page</i>
<i>Cable System or VHF/UHF</i>	22
<input type="checkbox"/> No cable box or VCR	
<i>Cable Box and Antenna</i>	23
<input type="checkbox"/> Cable box unscrambles only some channels (usually premium channels)	
<input type="checkbox"/> No VCR	
<i>Cable Box</i>	24
<input type="checkbox"/> Cable box unscrambles all channels	
<input type="checkbox"/> No VCR	
<i>Satellite Receiver</i>	25
<i>Digital Cable Box or Digital Satellite Receiver</i>	26
<i>Equipment with HDMI Connection</i>	27
<i>Equipment with DVI Connection</i>	28
<i>Equipment with Digital Audio (OPTICAL)</i>	29

If you are connecting a VCR

- See the connections described on pages 34 and 35.

Cable System or VHF/UHF

For best results, use this connection if you:

- Have a cable and/or an antenna.
(This is convenient if you are using a separate rooftop antenna to receive additional channels that are not provided by your cable TV company.)
- Do not have a cable box or VCR. (If you have a cable box, see pages 23 and 24. If you have a VCR, see pages 34 and 35.)

Antenna System

Cable Type Connect As Shown

Cable TV (CATV)
and Antenna

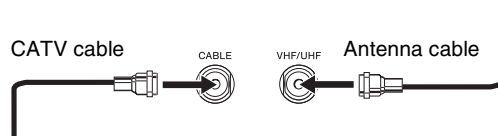

Notes on Using This Connection

To Do This...

Do This ...

Switch the TV's input between the cable and antenna

Press ANT to switch back and forth between the TV's VHF/UHF and CABLE inputs.

 **Do not use an indoor antenna, which is especially susceptible to radio noise.**

Cable Box and Antenna

Before connecting a cable box, see "Using CableCARD Device" on page 30.

For best results, use this connection if:

- ❑ Your cable company scrambles some channels, such as premium channels (which requires you to use a cable box), but does not scramble all channels.
- ❑ You do not have a VCR. (If you have a VCR, see pages 34 and 35.)

With this connection you can:

- ❑ Use the TV's remote control to change channels coming through the cable box to the TV's CABLE input. (You must first program the remote control for your specific cable box; see "Programming the Remote Control" on page 47.)
- ❑ Use the TV's remote control to change channels coming directly into the TV's VHF/UHF input jack.

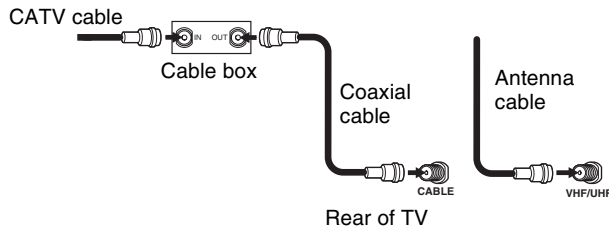

Notes on Using This Connection

To Do This ...	Do This ...
Use the cable box	Tune the TV to the channel the cable box is set to (usually channel 3 or 4) and then use the cable box to switch channels.
Set up the TV remote control to operate the cable box	Program the remote control. See "Programming the Remote Control" on page 47.
Activate the remote control to operate the cable box	Press SAT/CABLE (FUNCTION) once, and the SAT/CABLE indicator lights up.
Prevent the accidental switching of TV channels	When using the cable box, ensure that the TV remains tuned to the channel that the cable box is set to (usually channel 3 or 4).
Switch the TV's input between the cable box and antenna	Press ANT to switch back and forth between the TV's VHF/UHF (scrambled channels) and CABLE (unscrambled) inputs.

Cable Box

Before connecting a cable box, see "Using CableCARD Device" on page 30.

For best results, use this connection if:

- ❑ Your cable company scrambles all channels, which requires you to use a cable box.
- ❑ You do not have a VCR. (If you have a VCR, see pages 34 and 35.)

With this connection you can:

- ❑ Use the TV's remote control to change channels coming through the cable box to the TV's VHF/UHF input jack. (You must first program the remote control for your specific cable box.)

To connect the cable box

- 1** Connect the CATV cable to the cable box's input jack.
- 2** Use a coaxial cable to connect the cable box's output jack to the TV's VHF/UHF input jack.
- 3** Run Auto Program, as described in "Setting Up the Channel List" on pages 32.

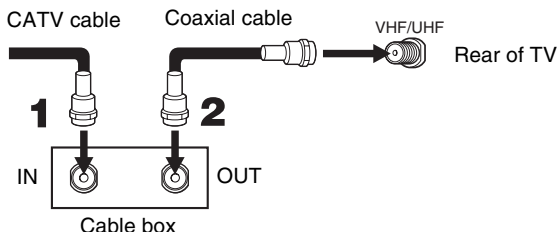

Notes on Using This Connection

To do this...	Do This ...
Use the cable box	Tune the TV to the channel the cable box is set to (usually channel 3 or 4) and then use the cable box to switch channels.
Set up the TV remote control to operate the cable box	Program the remote control. See "Programming the Remote Control" on page 47.
Activate the remote control to operate the cable box	Press SAT/CABLE (FUNCTION) once, and the SAT/CABLE indicator lights up.
Prevent the accidental switching of TV channels	When using the cable box, ensure that the TV remains tuned to the channel that the cable box is set to (usually channel 3 or 4).

Satellite Receiver

Disconnect all power sources before making any connections.

- 1** Connect the satellite antenna cable to the satellite receiver's SATELLITE IN jack.
- 2** Use A/V and S VIDEO cables to connect the satellite receiver's AUDIO and S VIDEO OUT jacks to the TV's AUDIO and S VIDEO IN jacks.
- 3** Use a coaxial cable to connect your cable to the TV's CABLE jack, or your antenna to the TV's VHF/UHF jack.

 **If your satellite receiver is not equipped with S VIDEO, use a VIDEO cable (yellow) instead of the S VIDEO cable.**

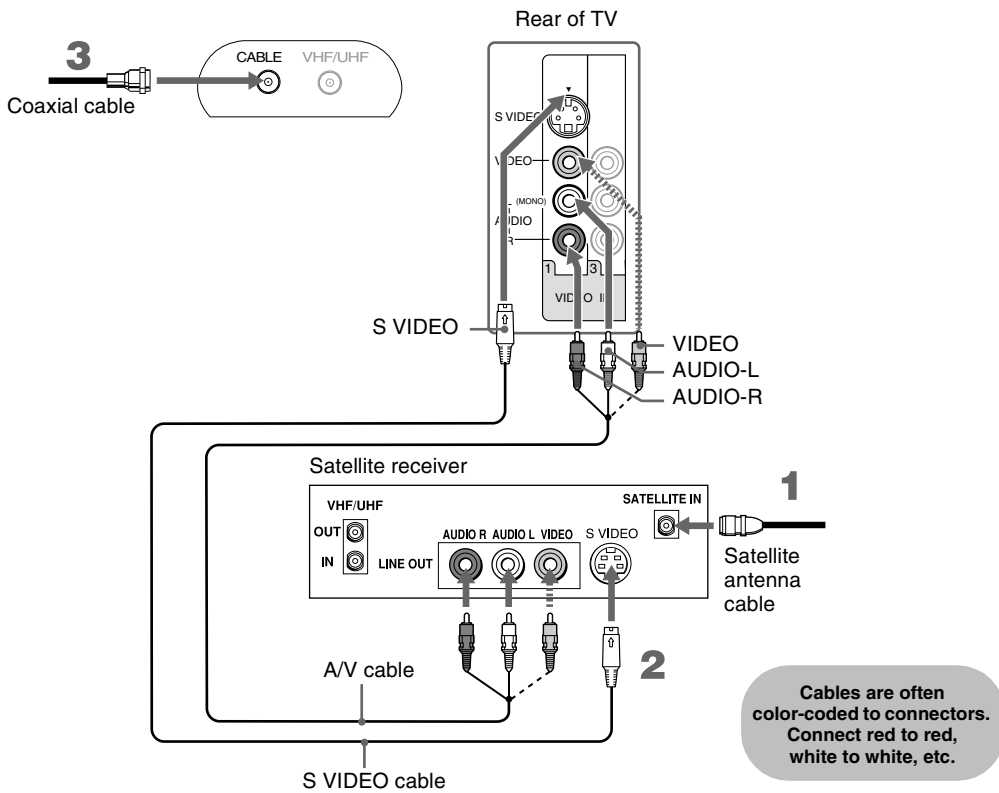

Connecting the TV

**Digital Cable Box or
Digital Satellite
Receiver**

Disconnect all power sources before making any connections.

- 1 Connect the RF coaxial cable from the CATV or satellite dish to the input of the digital cable box or digital satellite receiver.
- 2 Use a component video cable to connect the digital cable box or satellite receiver's YP_BP_R jacks to the TV's Y P_B/C_B P_R/C_R jacks. Use the HD/DVD IN 4 or 5 input.

 **Component video (Y P_B/C_B P_R/C_R) connection is necessary to view 480p, 720p, and 1080i formats. Note that this TV displays all format types of picture in a resolution of 1280 dots x 720 lines.**

- 3 Use an audio cable to connect the digital cable box or satellite receiver's AUDIO OUT jacks to the TV's AUDIO IN jacks.

 **The Y P_B/C_B P_R/C_R jacks do not provide audio, so audio cables must be connected to provide sound.**

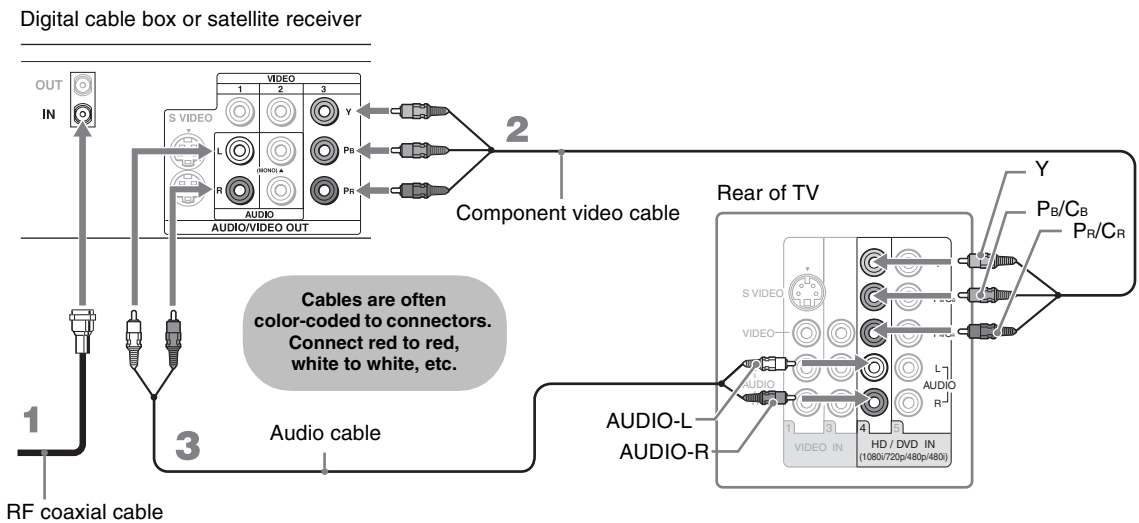

Equipment with HDMI Connection

💡 The HDMI jack provides both video and audio signals, so it is not necessary to connect an audio cable.

Use this hookup if:

- Your equipment has a High-Definition Multimedia Interface (HDMI).

Disconnect all power sources before making any connections.

Using an HDMI cable, connect the equipment's HDMI OUT jack to the TV's HDMI IN jack.

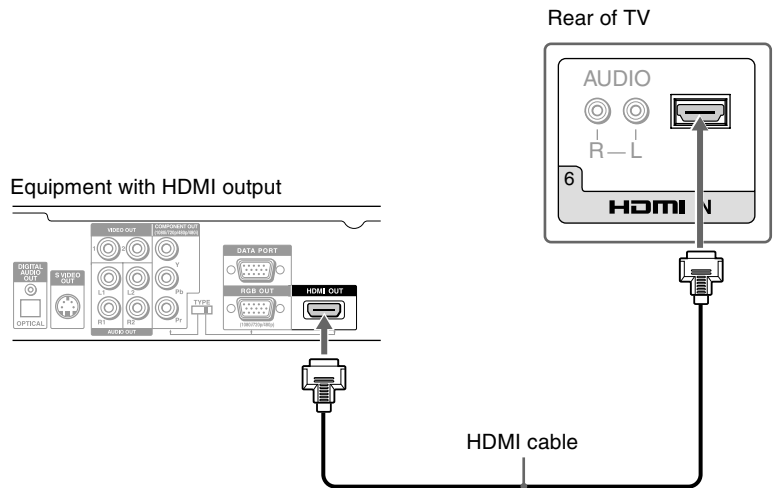

Equipment with DVI Connection

Disconnect all power sources before making any connections.

If you are connecting with DVI-HDTV output, you can connect to the TV's HDMI IN jack by using an HDMI-to-DVI cable or an adapter (both not supplied).

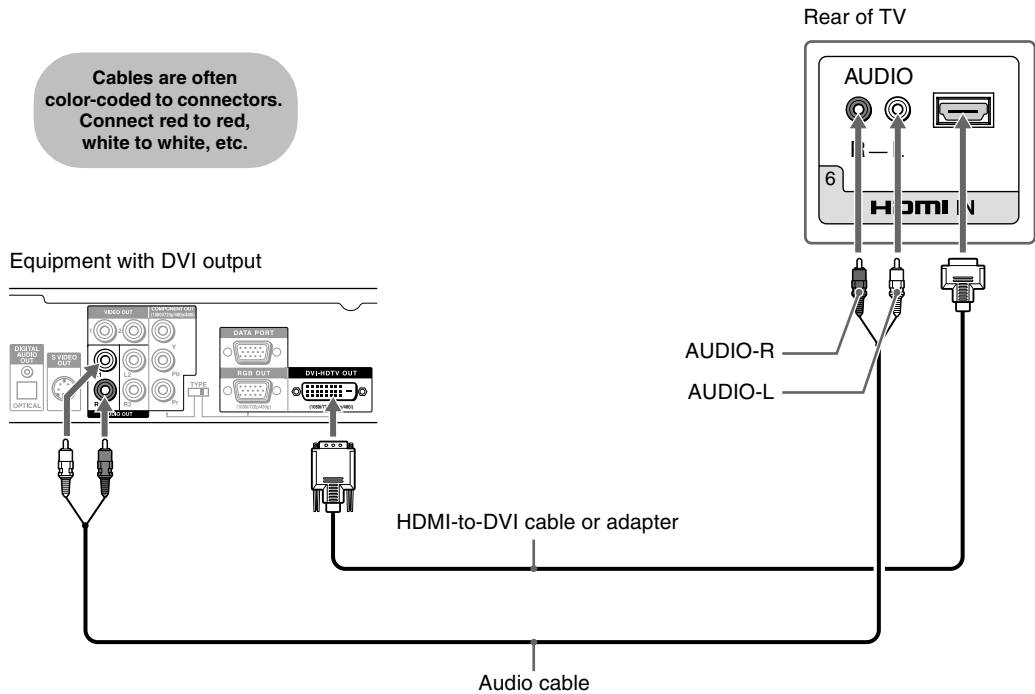

 **When using a HDMI-to-DVI cable or an adapter, be sure to connect the DVI output connector first; then connect to the HDMI input on your TV.**

Equipment with Digital Audio (Optical)

Disconnect all power sources before making any connections.

You can use the TV's DIGITAL AUDIO (OPTICAL) OUT jack to connect a digital audio device that is PCM/Dolby Digital compatible, such as an audio amplifier.

Using an optical audio cable, connect the device's OPTICAL IN jack to the TV's DIGITAL AUDIO (OPTICAL) OUT jack.

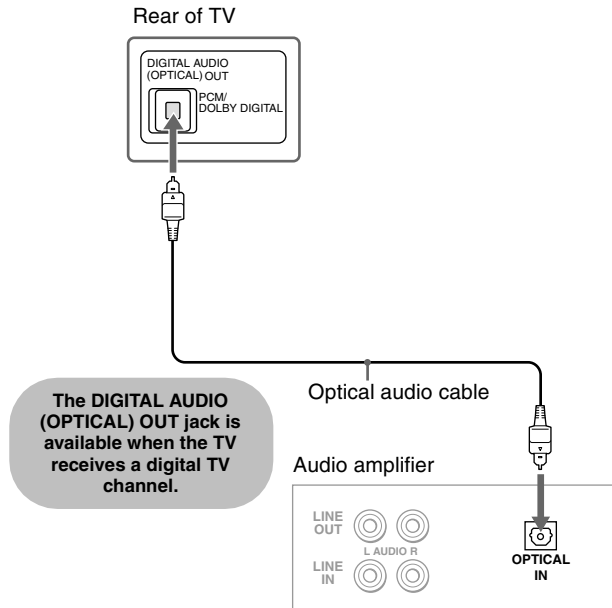

Using CableCARD Device

The CableCARD device provides cable subscribers with access to digitally encrypted cable channels — without the need for a set-top box — that will enable you to receive not only standard definition but also high definition television. The CableCARD device, which is provided by your cable TV company, is inserted into the TV's rear panel CableCARD slot. After the service is activated with your cable TV company, the card replaces the need for a separate set-top box.

About Using CableCARD Device

If you are planning to use a separate cable box for digital cable TV services, you may be able to receive programming using this TV with the CableCARD device instead — except in the following circumstances:

- ❑ Your cable TV company does not provide CableCARD service in your viewing area.
- ❑ You want to access your cable TV company's interactive or advanced features (such as video-on-demand or, in some cases, pay-per-view). At this time, these services require a bidirectional link, which are only available through the use of a separate set-top box. CableCARD device is currently a unidirectional device only, and cannot provide these advanced services.

Check with your cable TV company for CableCARD service details, limitations, pricing, and availability, all of which are determined by your cable TV company — not Sony.

Activating CableCARD Service

Before you can use CableCARD service, you need to insert the CableCARD device (supplied by your cable TV company) and activate the service, as described below:

- 1** Insert the CableCARD device into the CableCARD slot.

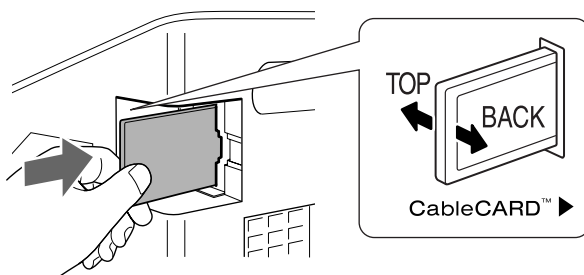

 **CAUTION:** When inserting the CableCARD device, the rear side of the card should face forward. Inserting the CableCARD incorrectly may result in permanent damage to the card and the TV.

- 2** Gently push the card into the slot until it locks into place.

 You can also access information about your CableCARD device in the Applications settings (see page 84).

Removing the CableCARD Device

- 3** After 1-2 minutes, the CableCARD device setup screen is automatically displayed. This screen includes information your cable TV company will request before they can activate your service.
- 4** Follow the displayed instructions: Phone your cable TV company. A representative will guide you through the activation process.
- 5** After your CableCARD device is activated, your cable TV company will download the service information, including the channel list, to the CableCARD device. After the CableCARD device has acquired channels from your cable TV company, the TV tunes to the lowest available channel.

In the event you want to cancel your service, contact your cable TV company.

 **Once the CableCARD device is removed, your TV will no longer decrypt digital cable TV programming services that require CableCARD.**

- 1** Push the eject button on the CableCARD slot to release the card.

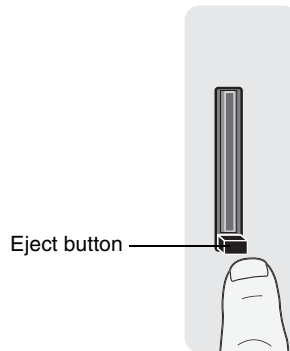

- 2** Pull the CableCARD device straight out of the slot to remove it. To install a different CableCARD device, follow the instructions in “Activating CableCARD Service” on page 30.

Setting Up the Channel List







After you finish connecting the TV, you can run the Initial Setup to create a list of available analog and digital channels. The Initial Setup screen appears when you turn on the TV for the first time after hooking it up. If you choose to set up the channels at a later time, select the Auto Program option in the Channel setting to scan available channels (see below).

 **The Initial Setup feature does not apply for installations that use a cable box for all channel selection.**

Using Initial Setup

 If you are using a CableCARD device, Auto Program is disabled for the CABLE input.

To run Initial Setup the first time you turn on your TV

- 1 Press  to turn on the TV. The Initial Setup screen appears.
- 2 Press  or  to highlight the on-screen display language. Then press . The messages “First please connect cable and/or antenna” appears. This may require 50+ minutes for completion and “Start auto program now?” appears.
- 3 Press  or  to highlight “Yes” then press .



Auto Program performed through Initial Setup will automatically create a list of receivable channels from both VHF/UHF antenna and cable TV channels if both sources are connected.

 **Auto Program may take a while (20 to 50 minutes) to complete. A progress bar is displayed while available channels are being scanned. If you cancel the Auto Program before all receivable channels are scanned, you may want to perform the task later (see “To run Auto Program at a later time” below).**

 **If you selected “No” during the Initial Setup, the Initial Setup message will appear each time you turn on the TV until you complete the Auto Program as a reminder.**

To run Auto Program at a later time

- 1 Select Settings in WEGA GATE, and then go to Channel settings.
- 2 Select Auto Program then select Start.

 **Auto Program will create a list of receivable channels for the current input (VHF/UHF antenna or CABLE). You will be required to run Auto Program for each RF input to create a list of available channels from both inputs.**

Connecting Optional Equipment

You can connect a variety of optional equipment to your TV. This section provides some of the individual connections you can make. For multiple connections, please refer to the Quick Setup Guide.

<i>If You Are Connecting</i>	<i>See Page</i>
VCR and Cable	34
VCR and Cable Box	35
Two VCRs for Tape Editing	37
DVD Player with Component Video Connectors	38
DVD Player with S VIDEO and Audio Connectors	39
Personal Computer	40
Camcorder or “PlayStation”	41
Audio Receiver	42

VCR and Cable

Use this hookup if:

- You have cable TV that does not require a cable box.

Disconnect all power sources before making any connections.

- 1** Connect the CATV cable to the single (input) jack of the splitter.
- 2** Use a coaxial cable to connect one of the output jack of the splitter to the TV's CABLE jack.
- 3** Use a coaxial cable to connect the splitter's other output jack to the VCR's input jack.
- 4** Use A/V and S VIDEO cables to connect the VCR's AUDIO and S VIDEO OUT jacks to the TV's AUDIO and S VIDEO IN jacks.

 **If your VCR is not equipped with S VIDEO, use a VIDEO cable (yellow) instead of the S VIDEO cable.**

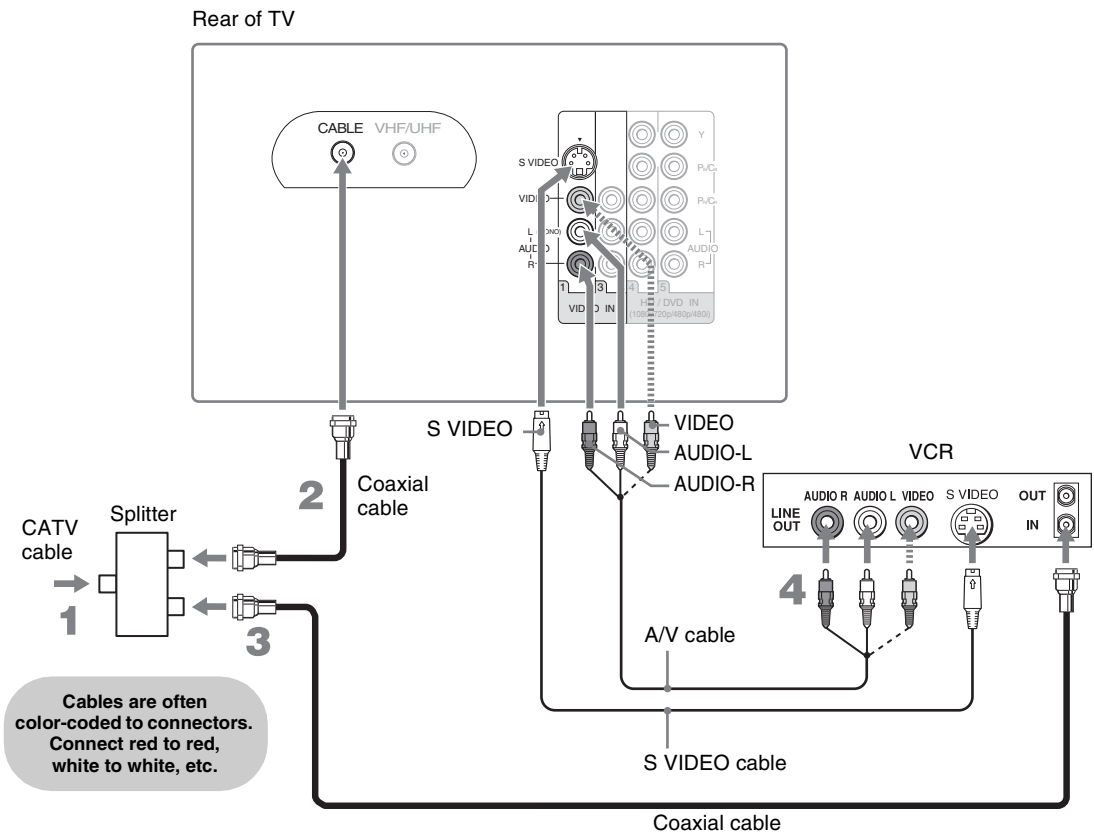

VCR and Cable Box

Before connecting a cable box, see "Using CableCARD Device" on page 30.

Use this hookup if:

- ❑ Your cable TV company scrambles some channels, but not all of them (pay channels vs. regular cable channels) and you need to use a cable box.

With this connection you can:

- ❑ Use the TV's remote control to change channels on your cable box when the signal is scrambled. To program your Sony remote control to operate your cable box, see "Programming the Remote Control" on page 47.
- ❑ Use the TV's remote control to change channels on your TV when the signal is not scrambled. Your TV's tuner provides a better picture quality than the output of your cable box.

Disconnect all power sources before making any connections.

- 1** Connect the CATV cable to the single (input) jack of the splitter.
- 2** Use a coaxial cable to connect one of the output jack of the splitter to the TV's CABLE jack.
- 3** Use a coaxial cable to connect the splitter's other output jack to the cable box's input jack.
- 4** Use a coaxial cable to connect the cable box's output jack to the VCR's RF input jack.
- 5** Use an A/V cable to connect the cable box's A/V output jacks to the TV's A/V input jacks.
- 6** Use an A/V and S VIDEO cables to connect the VCR's AUDIO and S VIDEO OUT jacks to the TV's AUDIO and S VIDEO IN jacks.

 **If your VCR is not equipped with S VIDEO, use a VIDEO cable (yellow) instead of the S VIDEO cable.**

- 7** Run Initial Setup, as described in "Setting Up the Channel List" on page 32.

 **To view scrambled channels, tune the TV to the channel the cable box is set to (usually channel 3 or 4) and then use the cable box to switch channels.**

(Continued)

Connecting the TV

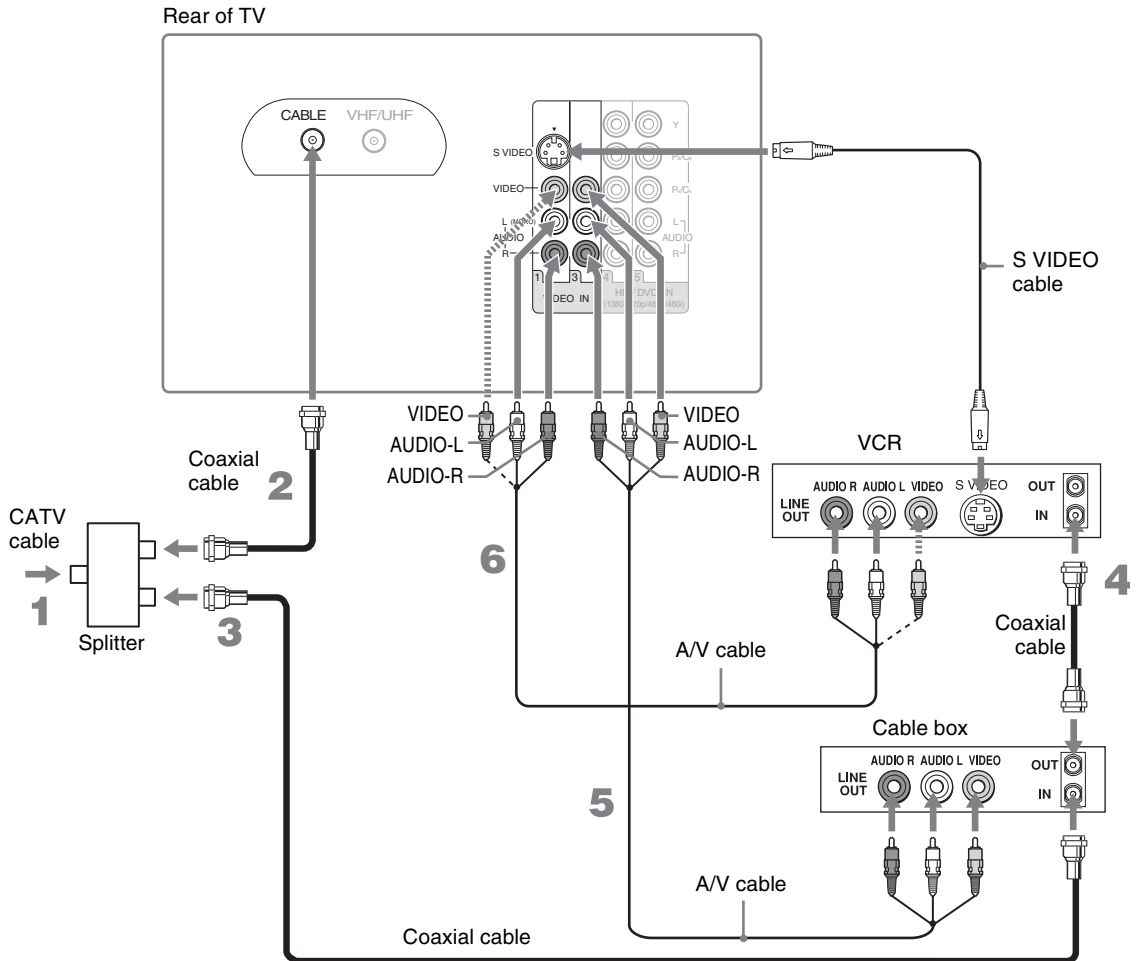

Cables are often color-coded to connectors. Connect red to red, white to white, etc.

If you are connecting a digital cable box, you will need a special bi-directional splitter designed to work with your cable box.

Two VCRs for Tape Editing



Using
S VIDEO jacks?
See page 20.

If you connect two VCRs, you can record from one VCR to the other while using your TV to monitor what is being recorded.

Disconnect all power sources before making any connections.

- 1** Use an A/V cable to connect the playback VCR's A/V output jacks to the recording VCR's A/V input jacks.
- 2** Use an A/V cable to connect the recording VCR's A/V output jacks to the TV's A/V input jacks.

Cables are often color-coded to connectors. Connect red to red, white to white, etc.

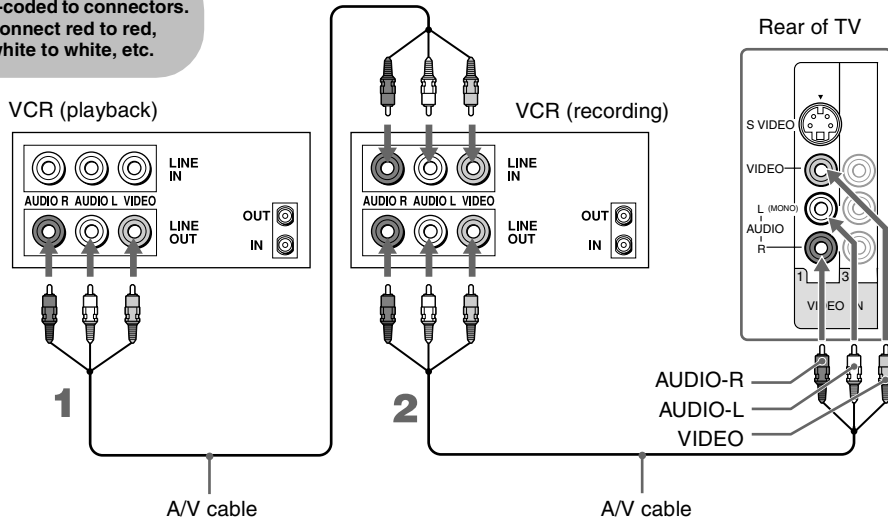

- To perform tape editing, set the TV to the video input intended for playback by pressing TV/VIDEO on the remote control.**
- You may need to change the video input on your VCR. See your VCR's operating manual for instructions.**
- If your VCRs have S VIDEO jacks: For best picture quality, use an S VIDEO connection instead of the VIDEO cable (yellow) on your combined A/V cable. Using an S VIDEO cable, connect the playback VCR's S VIDEO OUT jack to the recording VCR's S VIDEO IN jack. S VIDEO does not provide audio, so audio cables must be connected to provide sound.**
- You cannot record signals from equipment connected to the Y Pb/Cb Pr/Cr input.**

DVD Player with Component Video Connectors

Use this hookup if:

- Your DVD player has component (YP_BPr) jacks.

Disconnect all power sources before making any connections.

- 1** Use a component video cable to connect the DVD player's YP_BPr jacks to the TV's Y P_B/C_B Pr/C_R jacks. Use the HD/DVD IN 4 or 5 input.

 **The YP_BPr jacks on your DVD player are sometimes labeled YC_BCr, or Y, B-Y and R-Y. If so, connect the cables to like colors.**

- 2** Use an audio cable to connect the DVD player's AUDIO OUT jacks to the TV's AUDIO IN jacks. Be sure to use the same row of inputs that you used for the video connection (HD/DVD IN 4 or 5).

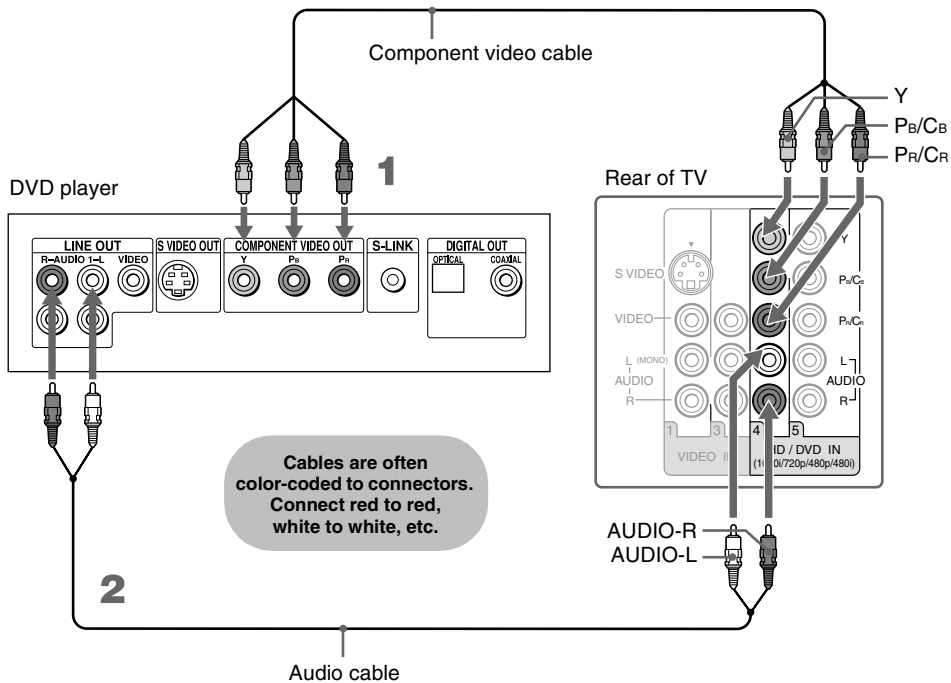

 **To take advantage of the Wide Mode feature, set the DVD player's aspect ratio to 16:9. For details, refer to the operating instructions supplied with your DVD player.**

DVD Player with S VIDEO and Audio Connectors





Use this hookup if:

- Your DVD player does not have component (YPbPr) jacks.

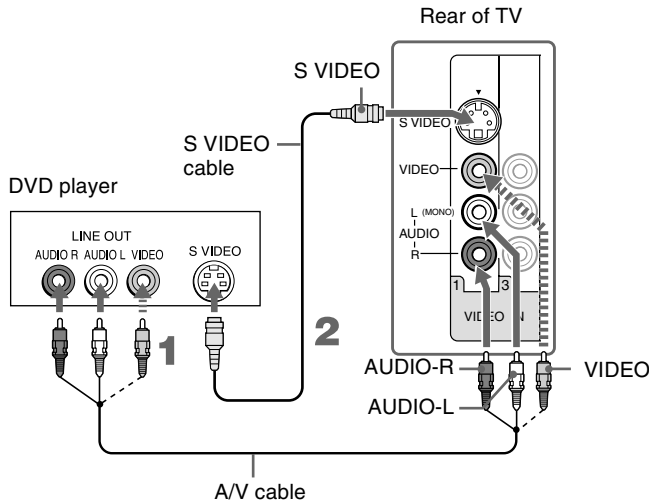
Disconnect all power sources before making any connections.

- 1** Use an A/V cable to connect the DVD player's AUDIO OUT jacks to the TV's AUDIO IN jacks.
- 2** Use an S VIDEO cable to connect the DVD player's S VIDEO jack to the TV's S VIDEO jack.



-  If your DVD player is not equipped with S VIDEO, use a VIDEO cable (yellow) instead of the S VIDEO cable.
-  To watch the DVD player, press TV/VIDEO repeatedly to select the DVD input (VIDEO 1 in the illustration). If you have a non-Sony DVD player and want to set up the TV remote control to operate it, you must program the remote control. See "Programming the Remote Control" on page 47.
-  To control DVD functions with the TV remote control, see "Operating a DVD Player or DVD Changer" on page 49.
-  To easily identify equipment connected to the TV, see the instructions for setting up Label Video Inputs on page 79.

Personal Computer

💡 When connecting to an Apple Macintosh computer, use the HD15-HD15 cable to connect PC IN of the TV to video output connector of the computer. For some Apple Macintosh computers, it may be necessary to use an adapter (not supplied). If this is the case, connect the adapter to the computer before connecting the HD15-HD15 cable.

💡 If the picture is noisy or flickering, adjust the Phase and Pitch in the Screen settings on page 71.

To connect a PC (personal computer)

If you connect your PC to the TV, you can watch your personal computer's display on the TV.

When your PC is connected to the TV with the HD15-HD15 cable and optional audio cable, you can view and listen to the PC's video and audio output on the TV.

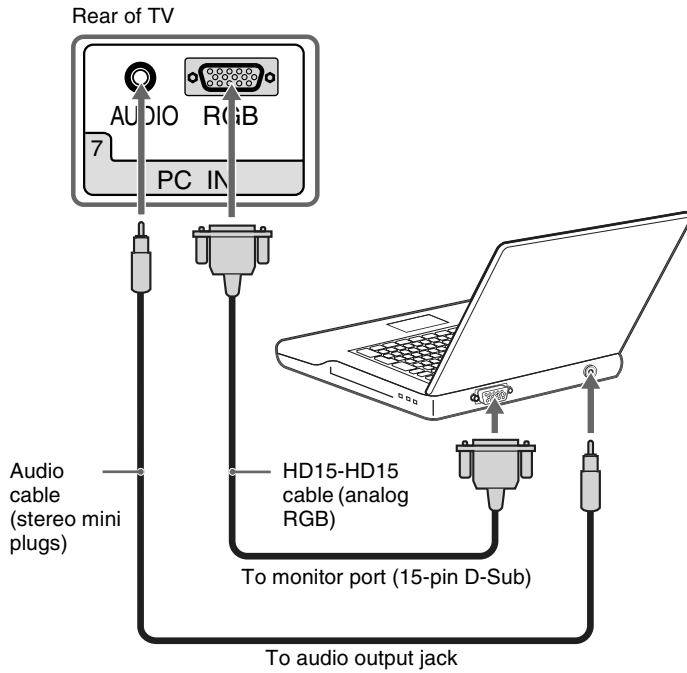

Camcorder or "PlayStation"



You can connect a camcorder or "PlayStation" to your TV. For easy connection, use VIDEO IN 2 on the left side of the TV. To use the S VIDEO jack instead of the VIDEO jack (yellow), use VIDEO IN 1 on the rear panel of the TV.

To connect a camcorder or "PlayStation" to VIDEO IN 1

Use A/V and S VIDEO cables to connect the AUDIO and S VIDEO OUT jacks on the camcorder or "PlayStation" to the AUDIO and S VIDEO IN jacks on the rear panel of the TV, as shown below.

To connect a camcorder or "PlayStation" to VIDEO IN 2

Select Off in the Video 2 (Component) option in the Setup settings (see page 79). Use an A/V cable to connect the A/V output jacks on the camcorder or "PlayStation" to the A/V input jacks on the left side of the TV.

-  **If your camcorder is not equipped with S VIDEO, use a VIDEO cable (yellow) instead of the S VIDEO cable.**
-  **If you have a mono camcorder, connect its audio output jack to the TV's L MONO audio input jack.**

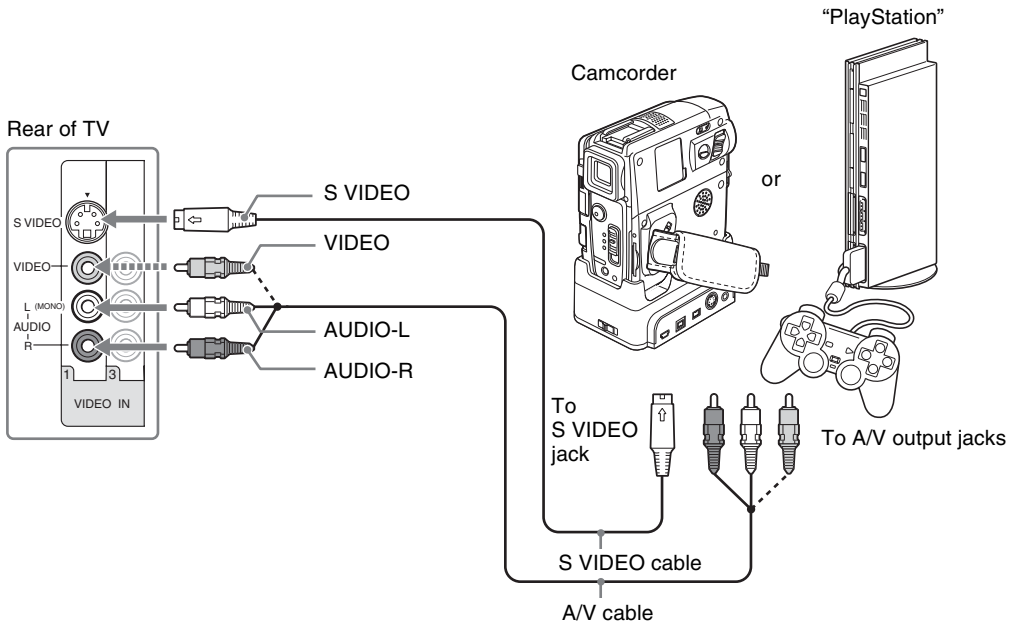

Audio Receiver

For improved sound quality, you may want to play the TV's audio through your stereo system (see page 67).

Disconnect all power sources before making any connections.

Using an audio cable, connect the TV's AUDIO OUT (VAR/FIX) jacks to the audio receiver's audio LINE IN jacks.

 **AUDIO OUT jacks are operable only when the TV's Speaker is set to Off.**

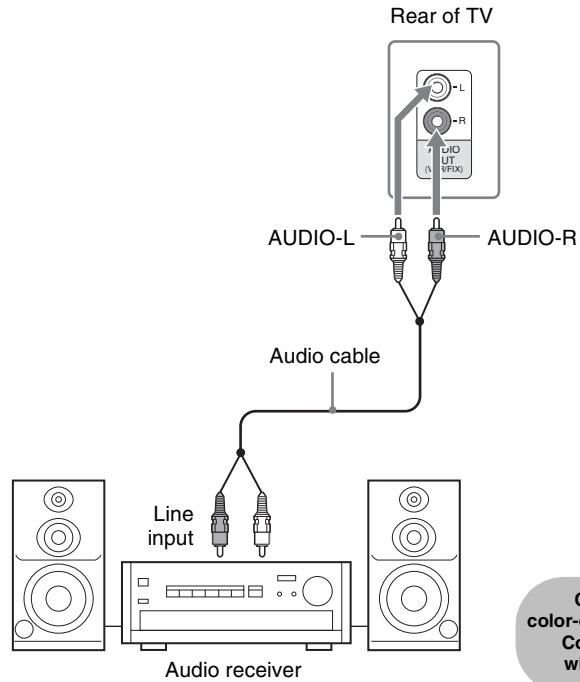

Watching the TV

Overview



The table on the next page describes the buttons on the remote control.

Topic	Page
Inserting Batteries into the Remote Control	43
Button Descriptions	44
Programming the Remote Control	47
Manufacturer's Codes	48
Using Other Equipment with Your Remote Control	49
Special Buttons on the Remote Control	51

Inserting Batteries into the Remote Control

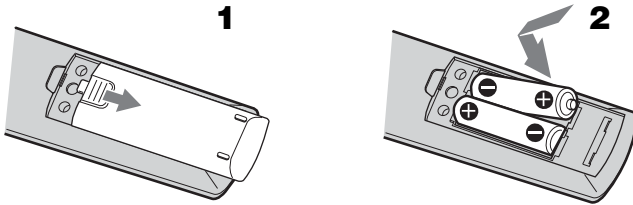
Insert two size AA (R6) batteries (supplied) by matching the \oplus and \ominus on the batteries to the diagram inside the battery compartment.



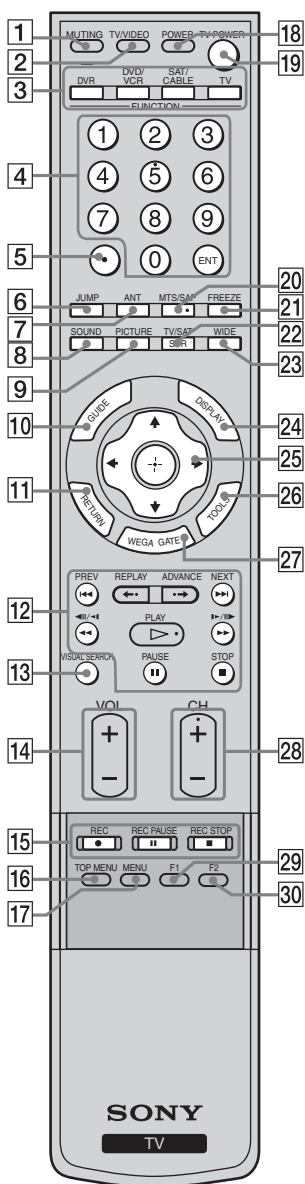

-  To avoid possible damage from battery leakage, remove the batteries if you anticipate the remote control will not be used for an extended period.
-  Handle the remote control with care. Avoid dropping it, getting it wet, or placing it in direct sunlight, near a heater, or in high humidity.
-  Your remote control can be programmed to operate most video equipment. (See “Programming the Remote Control” on page 47.)

Button Descriptions

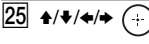

Button	Description
1 MUTING	Press to mute the sound. Press again or press VOL + to unmute.
2 TV/VIDEO	Press to cycle through the video equipment connected to your TV's video inputs.
3 FUNCTION Buttons	The FUNCTION button indicator lights up momentarily when pressed to show which external equipment the remote control is operating. When the remote control is set to operate the external equipment, these buttons will operate the equipment you choose. You must first press one of these FUNCTION buttons to operate the corresponding equipment. See page 47 for Programming the Remote Control.
4 0-9, ENT	Press 0-9 to select a channel: the channel changes after 2 seconds. Press ENT to change channels immediately.
5	Use with 0-9 and ENT buttons to select digital channels (for example, 2.1).
6 JUMP	Press to jump back and forth between two channels. The TV alternates between the current channel and the last channel that was selected.
7 ANT	Press to change between the VHF/UHF input and the CABLE input.
8 SOUND	Press to cycle through different sound settings: Dynamic for enhance treble and bass, Standard for spoken dialog and Custom for flat setting.
9 PICTURE	Press repeatedly to cycle through the available video picture modes: Vivid , Standard , Custom . The video picture modes can be also accessed in the Video menu. For details, see "Selecting Video Options" on page 63.
10 GUIDE	Press to display the TV's program guide.
11 RETURN	Press to return to the previous page.
12 DVD/VCR Operating Buttons	When FUNCTION is switched on DVR or DVD/VCR, these buttons operate the video equipment you have programmed into the remote control. For details, see "Using Other Equipment with Your Remote Control" on page 49. ◀◀ PREV: Press to replay the current program from the previous Chapter Mark (if any) or from the beginning of the live TV cache. ◀• REPLAY: Press to replay the current program for a set period of time. •➔ ADVANCE: Press to advance forward a set period of time when playing back a recorded program. ▶▶ NEXT: Press to advance forward to the next Chapter Mark (if any) or to live TV when playing back a recorded program. ◀◀ (fast reverse): Press to play a program in fast rewind mode. ▷• PLAY: Press to play a program at a normal speed. ▶▶ (fast forward): Press to play a program in fast forward mode. PAUSE: Press to pause playback. ■ STOP: Press to stop the playback of a recorded program.

The 5 button, CH + button, MTS/SAP and Play button have a tactile dot. Use the tactile dot as a reference when operating the TV.

Button	Description
13 VISUAL SEARCH	To be used only with your connected external equipment with visual search function. (Non-operable button for TV)
14 VOL +/-	Press to adjust the volume.
15 DVD/VCR Record Buttons	<ul style="list-style-type: none"> ● REC: Press to record. By pressing this button alone will start the recording. ▮▮ REC PAUSE: Press to pause the recording. ■ REC STOP: Press to stop the recording.
16 TOP MENU	Press to display the disc menu from your connected DVD player.
17 MENU	Press to display the disc menu from your connected DVD player.
18 POWER	Press to turn on/off the external equipment selected from the FUNCTION buttons [3].
19 TV POWER	Press to turn on/off the TV.
20 MTS/SAP	Press repeatedly to cycle through the Multi-channel TV Sound (MTS) options: Stereo, Auto SAP (Second Audio Program), and Mono. The MTS setting can be also accessed in the Audio setting. For more details, see “Selecting Audio Options” on page 66.
21 FREEZE	Press to freeze the current picture. Press again to restore the picture. For details, see “Using the FREEZE Button” on page 54.
22 TV/SAT/SUR	<p>TV/SAT: While in SAT/CABLE FUNCTION, press to switch between the satellite receiver and antenna.</p> <p>SUR: Press SUR (Surround Sound) repeatedly to step through the available audio effect models: TruSurround XT, Simulated, Off.</p>
23 WIDE	Press repeatedly to step through the Wide Screen Mode setting: Wide Zoom, Normal, Full and Zoom. The Wide Screen Mode setting can be also accessed in the Screen setting. For details, see “Using the WIDE Button” on page 53.
24 DISPLAY	Press once to display channel number, label, current time and other information. Press again to turn Display off. See page 83 for details on setting the time.
25 	Press  to move the on-screen cursor. To select an item, press  .
26 TOOLS	To be used only with your connected external equipment that supports this TOOLS function. (Non-operable button for TV)
27 WEGA GATE	<p>Press to access the following through the WEGA GATE:</p> <ul style="list-style-type: none"> • Watch TV (see page 58) • Select channels from the Favorites Channels you stored (see page 57) • View signals from external equipment such as DVD, VCR and others (see page 59). • Adjust or customize TV settings (see Using the Settings on page 59).
28 CH +/-	Press to scan through channels. To scan quickly through channels, press and hold down either +/- button.

(Continued)

Watching the TV

<i>Button</i>	<i>Description</i>
29 F1	Press to select the function of connected components. For details, see “Using Other Equipment with Your Remote Control” on page 49.
30 F2	Press to select the function of connected components. For details, see “Using Other Equipment with Your Remote Control” on page 49.

Programming the Remote Control

The remote control is preset to operate Sony brand video equipment.

Sony Equipment	Programmable Code Number
DVR	772
DVD/VCR	601 (Sony Dream System)
SAT/CABLE	801 (Sony Satellite Receiver)

Follow the steps below to program your TV's remote control to operate the non-Sony video equipment.

Find the three-digit code for your equipment from the "Manufacturer's Codes" listed on page 48. If more than one code number is listed, try entering from the code listed first.

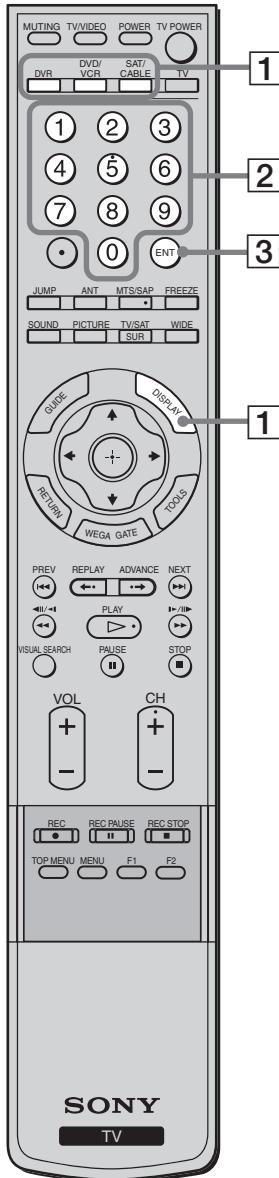

- 1 Press and hold the , or FUNCTION button you want to program on the remote control and press the button simultaneously. The selected FUNCTION button (DVR, DVD/VCR or SAT/CABLE) will flash.
- 2 Enter the three-digit manufacturer's code number using the - buttons while the button is lit. If code is not entered within 10 seconds, you must perform step 1 again.
- 3 Press button. When the programming is correct, the selected FUNCTION button will flash twice, and when not, flashes five times.

To check if the code works

Aim your TV's remote control at the equipment, and press the green button. If the equipment turns on and off, the programming is completed. If not, try the next code listed.

- If no code is input within the above specified time, or an invalid or incorrect code number is input, the remote control automatically goes back to the previous setting.**
- In some cases, you may not be able to program your remote control to operate other equipment. In such cases, use the equipment's own remote control.**
- Using dead batteries or removing the batteries may cause the programmable codes to be lost and revert back to factory settings. Reprogramming the codes may be necessary.**

Watching the TV

Manufacturer's Codes

DVD Players

Manufacturer	Code
Sony	751
General Electric	755
Hitachi	758
JVC	756
Magnavox	757
Mitsubishi	761
Panasonic	753
Philips	757
Pioneer	752, 778
RCA/PROSCAN	755
Samsung	758
Toshiba	754
Zenith	760

DVD Changers

Manufacturer	Code
Sony	765
Panasonic	766

DVD/VCR Combo Units

Manufacturer	Code
Sony	767
Broksonic	776
JVC	775
Panasonic	777
Samsung	774
Toshiba	773
Zenith	768

HDD/DVD Combo Units

Manufacturer	Code
Sony	772, 771, 770

5.1ch DVD AV System

Manufacturer	Code
Sony (DAV)	601, 602, 603, 604

AV Receivers

Manufacturer	Code
Sony	764

VCRs

Manufacturer	Code
Sony	301, 302, 303
Admiral (M. Ward)	327
Aiwa*	338, 344
Audio Dynamic	314, 337
Broksonic	319, 317
Canon	309, 308

Manufacturer	Code
Citizen	332
Craig	302, 332
Curtis Mathes	304, 338, 309
Daewoo	341, 312, 309
DBX	314, 336, 337
Dimensia	304
Emerson	319, 320, 316, 317, 318, 341
Fisher	330, 335
Funai	338
General Electric	329, 304, 309
Go Video	322, 339, 340
Goldstar	332
Hitachi	306, 304, 305, 338
Instant Replay	309, 308
JC Penney	309, 305, 304, 330, 314, 336, 337
JVC	314, 336, 337, 345, 346, 347
Kenwood	314, 336, 332, 337
LG	332
LXI (SEARS)	332, 305, 330, 335, 338
Magnavox	308, 309, 310
Marantz	314, 336, 337
Marta	332
Memorex	309, 335
Minolta	305, 304
Mitsubishi/MGA	323, 324, 325, 326
Multitech	325, 338, 321
NEC	314, 336, 337
Olympic	309, 308
Optimus	327
Orion	317
Panasonic	308, 309, 306, 307
Pentax	305, 304
Philco	308, 309
Philips	308, 309, 310
Pioneer	308
Quasar	308, 309, 306
RCA/PROSCAN	304, 305, 308, 309, 311, 312, 313, 310, 329
Realistic	309, 330, 328, 335, 324, 338
Sansui	314
Samsung	322, 313, 321
Sanyo	330, 335
Scott	312, 313, 321, 335, 323, 324, 325, 326

Manufacturer	Code
Sharp	327, 328
Signature 2000 (M. Ward)	338, 327
SV2000	338
Sylvania	308, 309, 338, 310
Symphonic	338
Tashiro	332
Tatung	314, 336, 337
Teac	314, 336, 338, 337
Technics	309, 308
Toshiba	312, 311
Wards	327, 328, 335, 331, 332
Yamaha	314, 330, 336, 337
Zenith	331

Cable Boxes

Manufacturer	Code
Sony	230
Hamlin/Regal	222, 223, 224, 225, 226
Jerrold/General Inst./Motorola	201, 202, 203, 204, 205, 206, 207, 208, 218, 222
Oak	227, 228, 229
Panasonic	219, 220, 221
Pioneer	211, 214, 215
Scientific Atlanta	209, 210, 211
Tocom	216, 217
Zenith	212, 213

Satellite Receivers

Manufacturer	Code
Sony	801
Dish Network	810
Echostar	810
General Electric	802
Hitachi	805
Hughes	804
Mitsubishi	809
Panasonic	803
Philips	811
RCA/PROSCAN	802, 808
Toshiba	806, 807
Samsung	812

* If an Aiwa VCR does not work even though you enter the code for Aiwa, enter the code for Sony instead.

Using Other Equipment with Your Remote Control

To operate other equipment connected to your TV, first turn to page 48 and program the necessary code. For operating video equipment, press TV/VIDEO repeatedly until you see the video input on the screen for your connected equipment. Remote control tips are provided below.

 **Some functions cannot be operated depending on the equipment. In that case, operate by the remote control supplied with the equipment.**

Operating a Cable Box

To Do This ...	Press ...
Activate the remote control to operate the cable box	SAT/CABLE (FUNCTION)
Turn on/off	POWER

Operating a Satellite Receiver

To Do This ...	Press ...
Activate the remote control to operate the satellite receiver	SAT/CABLE (FUNCTION)
Turn on/off	POWER
Select a channel	0-9, ENT
Change channels	CH +/-
Back to previous channel	JUMP
Display channel number	DISPLAY

Operating a VCR

To Do This ...	Press ...
Activate the remote control to operate the VCR	DVD/VCR (FUNCTION)
Turn on/off	POWER
Change channels	CH +/-
Record	●
Play	▷
Stop	■

Operating a DVD Player or DVD Changer

To Do This ...	Press ...
Activate the remote control to operate the DVD	DVD/VCR (FUNCTION)
Turn on/off	POWER
If you have a DVD changer, to skip disc	F1
Play	▷
Stop	■
Pause	(press again to resume normal playback)

To Do This ...	Press ...
Select a channel	0-9, ENT
Change channels	CH +/-
Back to previous channel	JUMP

To Do This ...	Press ...
Display SAT Guide	GUIDE
Display SAT Menu	MENU
Move highlight (cursor)	↑ ↓ ← →
Select item	⊕
Switch between the TV and satellite broadcasts	TV/SAT

To Do This ...	Press ...
Fast forward	▶▶
Rewind the tape	◀◀
Pause	(press again to resume normal playback)
Search the picture forward or backward	▶▶ or ◀◀ during playback (release to resume normal playback)

To Do This ...	Press ...
Step through different tracks of the disc	◀◀ to fast reverse or ▶▶ to fast forward the disc when pressed during playback
Step through different chapters of the disc	▶▶ to step forward or ◀◀ to step backward
Select a track directly	0-9, ENT
Display the disc menu	MENU
Display the top menu	TOP MENU
Operate the DVD menu	↑ ↓ ← →, ⊕

(Continued)

Watching the TV

Operating a 5.1ch DVD AV System (Sony DAV)

To Do This ...	Press ...
Activate the remote control to operate the DVD	DVD/VCR (FUNCTION)
Turn on/off	POWER
Select other equipment connected to the DAV	F1
Disk skip	F2
Display the top menu	TOP MENU
Display the disc menu	MENU

Operating a DVD/VCR Combo Unit

To Do This ...	Press ...
Activate the remote control to operate the DVD/VCR	DVD/VCR (FUNCTION)
Turn on/off	POWER
Select the DVD	F 1
Select the VCR	F 2
Display the top menu	TOP MENU
Display the disc menu	MENU
Play	▷
Stop	■
Pause	⏸

Operating a HDD/DVD Combo Unit

To Do This ...	Press ...
Activate the remote control to operate the DVD/HDD	DVR (FUNCTION)
Turn on/off	POWER
Select the HDD	F 1
Select the DVD	F 2
Play	▷
Stop	■
Pause	⏸
Search the picture forward or backward	▶▶ or ◀◀ during playback

Operating an AV Receiver

To Do This ...	Press ...
Turn on/off	POWER
Master volume	VOL +/-, MUTING
Select other input connected to AV receiver	F1

To Do This ...	Press ...
Play	▷
Stop	■
Pause	⏸
Search the picture forward or backward	▶▶ or ◀◀ during playback
Specify the previous chapter/track	⏮
Specify the next chapter/track	⏭
Move highlight (cursor)	⬆ ⬇ ⬇ ⬆
Select item	⊕
Master volume	VOL +/-, MUTING

To Do This ...	Press ...
Search the picture forward or backward	▶▶ or ◀◀ during playback
Replay	◀•
Advance	•▶
Move highlight (cursor) and select (DVD)	⬆ ⬇ ⬇ ⬆ ⊕
Record (VCR)	●
Change channels (VCR)	CH +/- or 0-9, ENT (using tuner)
Adjust tracking (VCR)	CH +/- (during tape playback)

To Do This ...	Press ...
Move highlight (cursor) and select	⬆ ⬇ ⬇ ⬆ ⊕
Record	●
Specify the previous chapter/track	⏮
Specify the next chapter/track	⏭
Replay	◀•
Advance	•▶
Display the disc menu	MENU
Display the top menu	TOP MENU

Special Buttons on the Remote Control

This TV comes with convenient features that can be accessed directly by pressing their buttons on your remote control.

Using the **GUIDE** Button

This TV is equipped to show program information if it is available from the station. The Program Guide lets you review program information, and select both analog and digital channels.

To display the Program Guide:

- 1** Tune your TV to a channel by using the 0-9, , and ENT buttons.
- 2** Press GUIDE on the TV's remote control. The Program Guide will appear with the currently selected program showing in the background.

Channel number, call letters, etc.

Program title and description, program duration, time remaining, rating information, closed-caption availability, etc.

Selectable channel list.

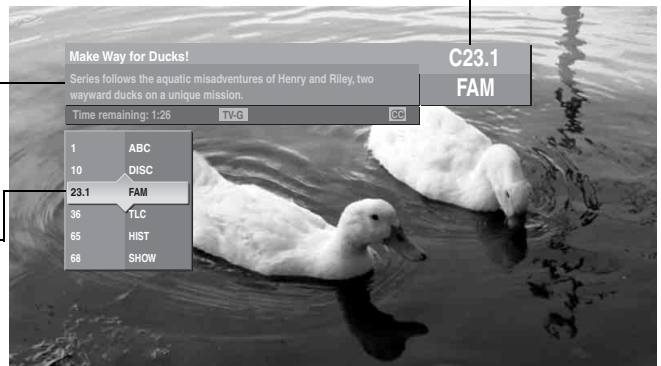



 **Program information in the guide is provided by the broadcasters. As a result, it may sometimes include only the channel number, without a program title or description.**

(Continued)

Using the Program Guide

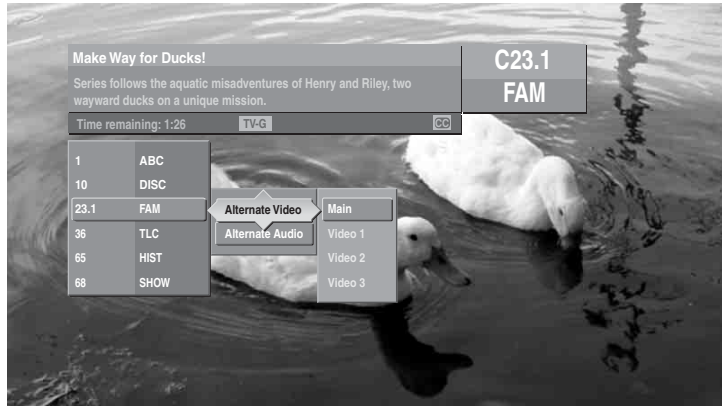
The Program Guide allows you to select the channels from a drop down list. The Guide also provides information about the current program being shown on each channel.



 **Subchannels are additional channels of programming broadcast simultaneously. For example, channel 4 might include three subchannels (4.1, 4.2, 4.3) that are showing programs at the same time.**

Using the Program Options Setting

The Program Options setting allows you to customize the program settings on the currently tuned channel.

<i>Option</i>	<i>Description</i>
Alternate Video (When available)	Each program has a main video stream (the video that you see when the channel is first tuned), and may have alternate video streams. This option allows you to switch among these alternate video streams.
Alternate Audio (When available)	Each program has a main audio stream (the audio you hear when the channel is first tuned), and may have alternate audio streams. This option allows you to switch among these alternate audio streams (e.g., for different languages).

Using the WIDE Button

Wide screen mode lets you watch 4:3 normal broadcasts in several wide screen modes (16:9 aspect ratio).

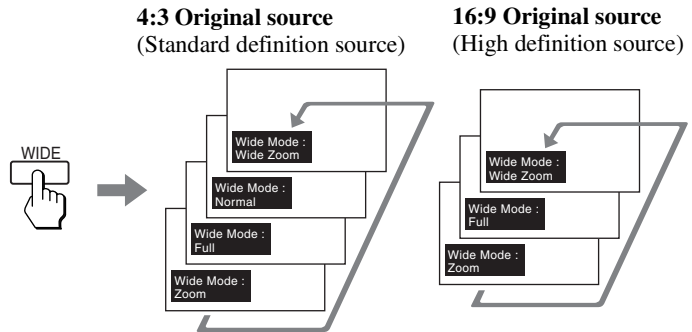

💡 When the TV receives a 720p or 1080i signal that is 4:3 aspect ratio picture with a black bar at each side, Full returns the picture to its original size.

💡 You can also access the Wide Mode settings in the Screen settings. For details, see page 69.

🔍 When the TV receives a 720p or 1080i signal, Normal cannot be selected.

Changing the wide screen mode

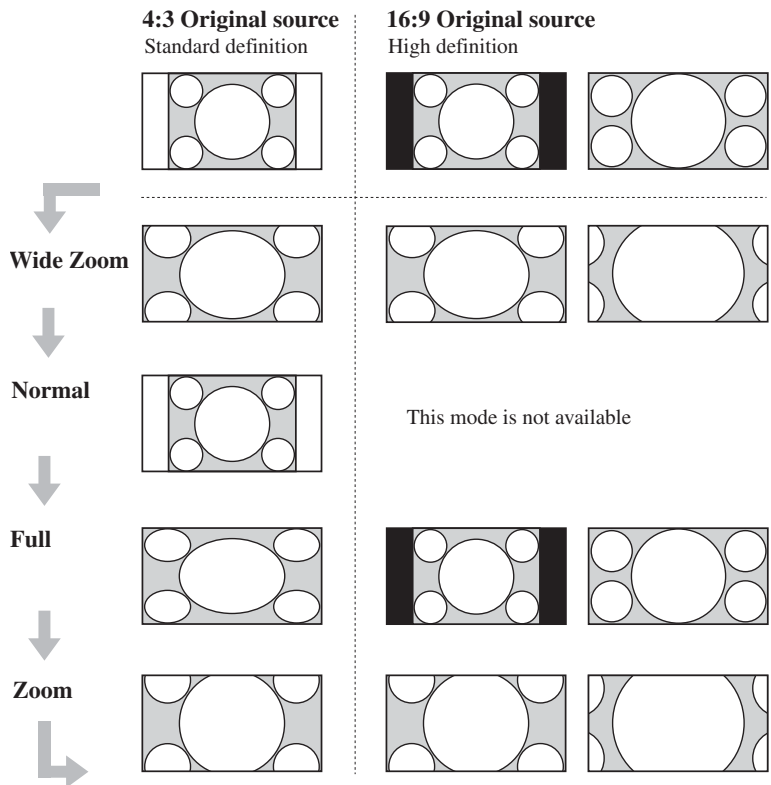

Using the JUMP Button

The JUMP button allows you to jump back and forth between the current channel and the last channel that was selected.



Using the FREEZE Button

The FREEZE button allows you to temporarily capture a program's picture. You can use this feature to write down information such as phone numbers, recipes, etc. To cancel FREEZE and return to normal viewing, press the FREEZE button again.

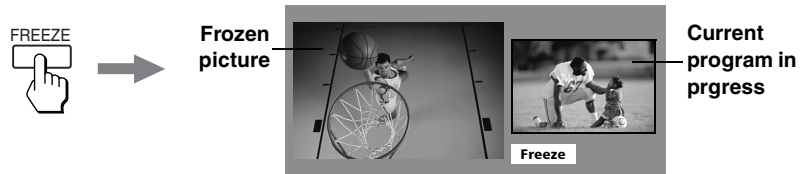

Introducing WEGA GATE

Overview of WEGA GATE

WEGA GATE provides one button access for controlling your TV. It enables you to perform a variety of tasks intuitively with a control panel on the screen rather than a variety of remote control button presses. When you press the  button, you can select from basic TV function: selecting from Favorite Channels, watching TV, viewing external equipment signals or adjusting TV settings.

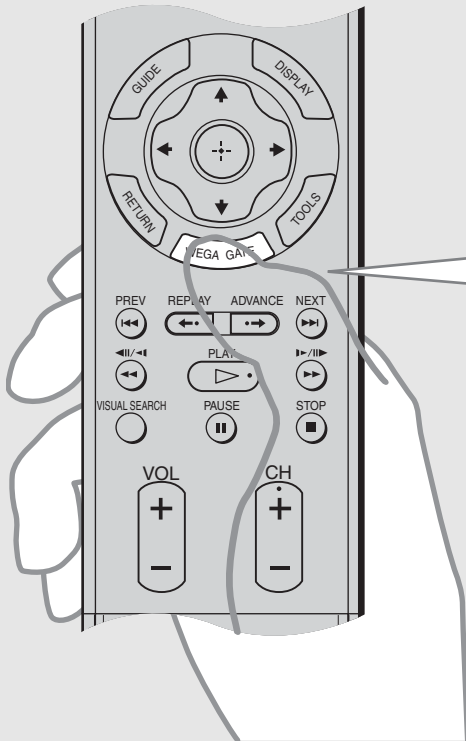

- 1 Press WEGA GATE on the remote. WEGA GATE control panel appears.

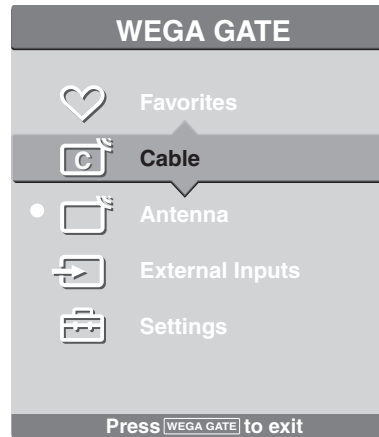





- 2 Press  to highlight the item.

- 3 Press  to select.

- 4 Press  to exit.

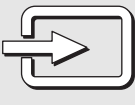
The WEGA GATE screen gives you access to the following items:

<i>Icon</i>	<i>Description</i>
 Favorites	The Favorites feature lets you select programs from a list of up to 16 favorite channels that you specify. For details, see page 57.
 Cable	The Cable feature takes you to the most recently viewed channel on the cable input. When tuned to the channel, the Program Banner and Channel number will be displayed. When this feature is active, ○ is displayed to the left of the icon.
 Antenna	The Antenna feature takes you to the most recently viewed channel on the antenna input. When tuned to the channel, the Program Banner and Channel number will be displayed. When this feature is active, ○ is displayed to the left of the icon.
 External Inputs	The External Inputs feature lets you select equipment that is connected to your TV, such as a DVD player. You can assign a label to your equipment or skip unused inputs conveniently. For details, see page 59. When this feature is active, ○ is displayed to the left of the icon.
 Settings	The Settings feature lets you adjust the Video, Audio, Screen, Channel, Parental Lock, Setup or Applications settings. For details, see page 59.

Navigating and Selecting Items

Use your remote control to navigate through WEGA GATE and the settings.

To Do This ...	Press ...
Display WEGA GATE control panel	Press WEGA GATE.
Display Settings	Press WEGA GATE and select Settings .
Move through Settings	Press ↑ ↓ ← → .
Select an option to change	Press + .
Move back to upper layer	Press RETURN .
Select (confirm) changed setting	Press + .
Exit WEGA GATE control panel or Settings	Press WEGA GATE.



Using Favorites in WEGA GATE

The Favorites feature lets you select programs from a list of up to 16 favorite channels that you specify. You can create a list using the Add to Favorites option.

- 1 Select Favorites from the WEGA GATE control panel and press **+**.

The Favorite Channels list appears. Make your selection.

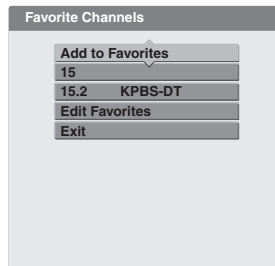



- 2 Press **↑/↓** to highlight the desired channel and press **+**.
 - To add the current channel to the list of Favorite Channels, highlight **Add to Favorites** and press **+**.
 - When the Favorite Channels list is full, select **Edit Favorites** to remove a channel from the list or go to the **Channel** settings and select **Favorite Channels** then edit the channel.

Using Cable in WEGA GATE

The Cable feature takes you to the most recently viewed channel on the cable input. When tuned to the channel, the Program Banner and Channel number will be displayed.

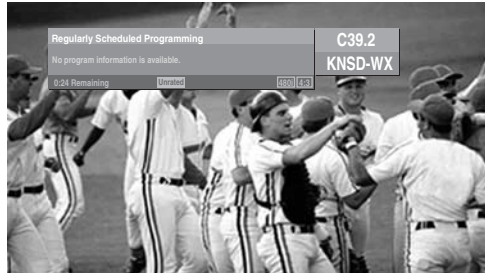
Select Cable from the WEGA GATE control panel and press .





 **If you have not completed the initial channel setup (see page 32) both Cable and Antenna will tune to the lowest channel number. To run Initial Setup see page 72.**

Using Antenna in WEGA GATE

The Antenna feature takes you to the most recently viewed channel on the antenna input. When tuned to the channel, the Program Banner and Channel number will be displayed.

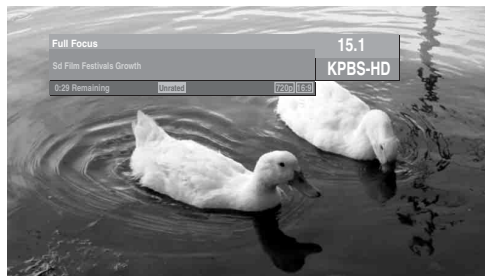
Select Antenna from the WEGA GATE control panel and press .



 **If you have not completed the initial channel setup (see page 32) both Cable and Antenna will tune to the lowest channel number. To run Initial Setup see page 72.**





Using External Inputs in WEGA GATE

The External Inputs feature lets you view from a selected external input connected to your TV. You can assign a label or skip over unused inputs by selecting **Edit Video Labels**. Input label assignment can also be done by going to Setup settings and select **Label Video Inputs** (see page 79).

- 1 Select **External Inputs** from the WEGA GATE control panel and press .

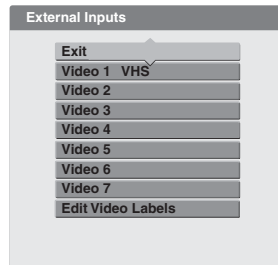
The External Inputs list appears. Make your selection.



- 2 Press **↑/↓** to highlight the desired external input and press .



Using Settings in WEGA GATE

The **Settings** feature lets you enter to the settings screen where most of advanced settings and adjustments are performed. See “Overview ” on page 61.

Using the Settings

Overview

The Settings give you access to the following features:

(Depending on the signal tuned, you may see a different Setting options on your screen. Settings displayed here are with the 720p signal.)

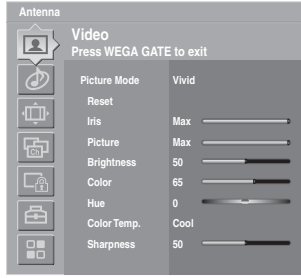
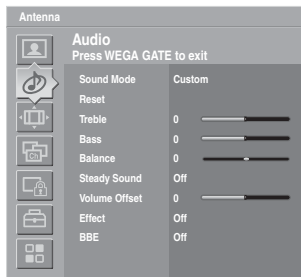
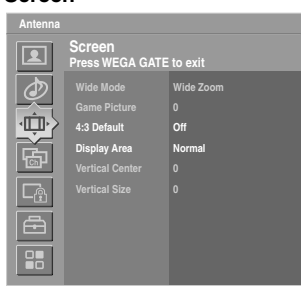
Settings	Allows you to set/change	
<p>Video</p> 	<ul style="list-style-type: none"> Picture Mode (page 63) Reset (page 63) Iris (page 63) Picture (page 63) Brightness (page 63) Color (page 63) Hue (page 63) Color Temp. (page 64) Sharpness (page 64) Noise Reduction (page 64) 	<ul style="list-style-type: none"> DRC Mode (page 64) DRC Palette (page 64) Advanced Video (page 65)
<p>Audio</p> 	<ul style="list-style-type: none"> Sound Mode (page 66) Reset (page 66) Treble (page 66) Bass (page 66) Balance (page 66) Steady Sound (page 66) Volume Offset (page 66) Effect (page 66) BBE (page 66) 	<ul style="list-style-type: none"> MTS (page 67) Speaker (page 67) Audio Out (page 67) A/V Sync (page 67)
<p>Screen</p> 	<ul style="list-style-type: none"> Wide Mode (page 69) Game Picture (page 69) 4:3 Default (page 70) Display Area (page 70) Vertical Center (page 70) Vertical Size (page 70) 	

(Continued)

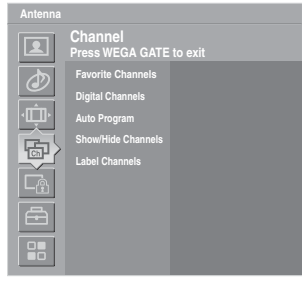
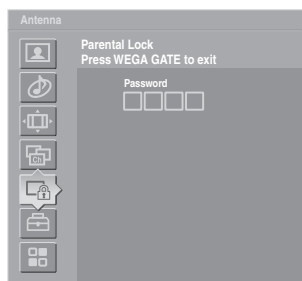
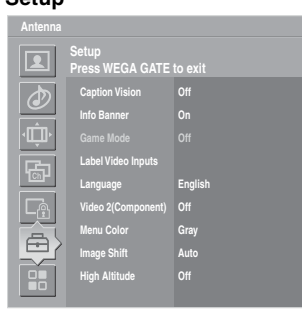
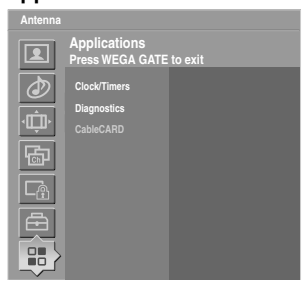
Settings	Allows you to set/change
<p>Channel</p> 	<ul style="list-style-type: none">Favorite Channels (page 72)Digital Channels (page 72)Auto Program (page 72)Show/Hide Channels (page 72)Label Channels (page 73)
<p>Parental Lock</p> 	<ul style="list-style-type: none">Parental Lock (page 74)Change Password (page 75)Select Country (page 75)
<p>Setup</p> 	<ul style="list-style-type: none">Caption Vision (page 78)Info Banner (page 78)Game Mode (page 78)Label Video Inputs (page 79)Language (page 79)Video 2 (Component) (page 79)Menu Color (page 79)Image Shift (page 79)High Altitude (page 80)CineMotion (page 80)
<p>Applications</p> 	<ul style="list-style-type: none">Clock/Timers (page 83)Diagnostics (page 84)CableCARD (page 84)

Accessing the Video Settings

1. Press WEGA GATE.....



2. Select Settings.....



3. Highlight.....



4. Press to select.....

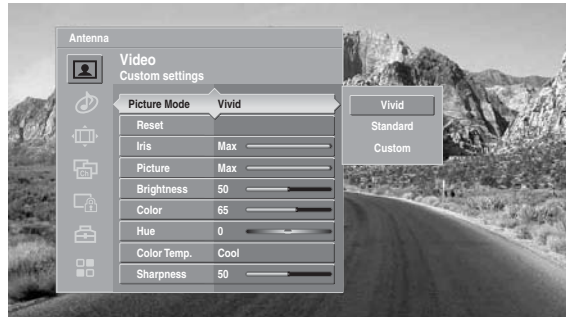

To highlight an option and to change settings, press **↑ ↓ ← →**.

Press **+** to confirm the selection.

To exit the Video, press **WEGA GATE**.





Selecting Video Options

💡 To quickly and easily change from one Picture Mode to another, use PICTURE on the remote control.

The Video settings include the following options:

Option	Description
Picture Mode	<p>Vivid Select for enhanced picture contrast and sharpness.</p> <p>Standard Select for standard picture settings. Recommended for home entertainment.</p> <p>Customized picture viewing Custom Select to display a picture with minimum enhancements.</p>
<p>📌 You can alter the Video settings (Picture, Brightness, Color, etc.) for each Mode and each video input.</p> <p>📌 You may set up a “Mode” (Vivid, Standard, Custom) independently for each Video input (Video 1-Video 6, including the Antenna input). Your “Mode” settings are automatically saved after each selection. This allows you to customize the Mode setting for each type of signal source.</p>	
Reset	Select OK to reset all settings and adjustments to the default setting (except for Advanced Video).
Iris	Adjust the contrast levels.
Picture	Adjust to increase picture contrast and deepen the color or decrease picture contrast and soften the color.
Brightness	Adjust to brighten or darken the picture.
Color	Adjust to increase or decrease color intensity.
Hue	Adjust to increase or decrease the green tones.

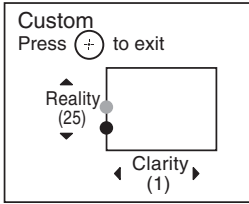
(Continued)

Option	Description
Color Temp. <i>White intensity adjustment</i>	Cool Select to give the white colors a blue tint.
	Neutral Select to give the white colors a neutral tint.
	Warm 1, 2 When selected Custom in Picture Mode, select to give the white colors a red tint.
Sharpness	Adjust to sharpen or soften the picture.
Noise Reduction	Select to reduce the noise level of connected equipment. This also reduces the noise level to the signal from the VHF/UHF jack. Select from Auto, High, Medium, Low and Off.
 When ATSC or Component is in use, Auto is not available.	
DRC Mode	High Density Creates a high-resolution picture with 4 x density, for high quality sources (i.e., DVD player, satellite receiver).
	Progressive Recommended for moving pictures.
	Off
 DRC Mode is not available when Game Mode is On or using the Freeze feature; also not available when watching 480p, 720p or 1080i sources.	
DRC Palette	Custom Allows you to customize the level of detail (Reality) and smoothness (Clarity) for up to three input sources. For example, you can create one Custom setting to optimize your cable input's picture, and create another to optimize your DVD player's picture. You can switch among the three Custom settings. <ol style="list-style-type: none"> Press the arrow buttons to highlight Custom then press  . The DRC palette appears.  <ol style="list-style-type: none"> Press the arrow buttons to adjust the position of the marker (●). As you move the ● higher along the Reality axis, the picture becomes more detailed. As you move the ● to the right along the Clarity axis, the picture becomes smoother. To save the setting, press  .
 DRC Palette is not available when Game Mode is On, Noise Reduction is set to Auto, DRC Mode is Off or using the Freeze feature; also not available when watching 480p, 720p or 1080i sources.	

Option	Description
Advanced Video <i>Available in "Custom Picture Mode"</i>	Program Select Program to choose among the options: Black Corrector (High/Medium/Low/Off), Advanced Iris (High/Medium/Low/Off), Gamma (Max/High/Medium/Low/Off), Clear White (High/Low/Off), Live Color (High/Medium/Low/Off).

Selecting PC Video Options

To display the PC screen:

Press TV/VIDEO repeatedly on the remote control until VIDEO 7 (PC) appears.

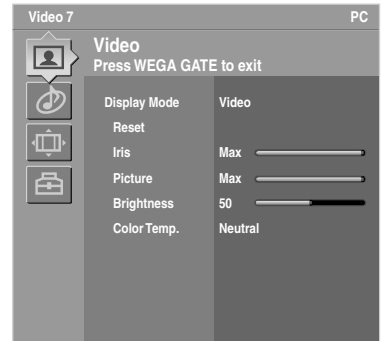

 You can change the settings for the PC input while the TV is displaying the PC screen.

The PC Input Video setting includes the following options:

Option	Description
Display Mode	Video Select to view video images.
	Text Select to view text, charts or tables.
Reset	Select to restore the factory default settings.
Iris	Select to adjust the contrast levels.
Picture	Adjust to increase or decrease picture contrast.
Brightness	Adjust to brighten or darken the picture.
Color Temp.	Choose from four color temperatures:
	Cool Select to give the white colors a blue tint.
	Neutral Select to give the white colors a neutral tint.
	Warm 1, 2 Select to give the white colors a red tint.



Accessing the Audio Settings

1. Press WEGA GATE.....



2. Select Settings.....



3. Highlight.....



4. Press to select.....

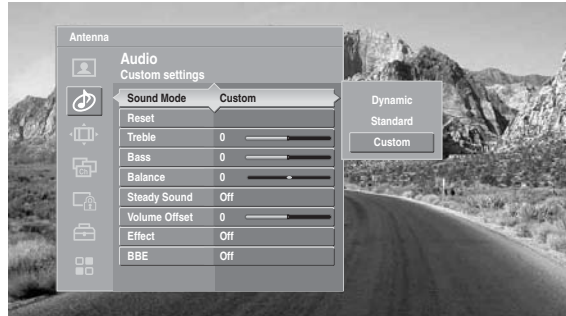



To highlight an option and to change settings, press $\uparrow \downarrow \leftarrow \rightarrow$.

Press \odot to confirm the selection.

To exit the Audio, press .



Selecting Audio Options

 Sound Mode settings are independent of settings in the Treble/Bass options.

 TruSurround XT attempts to create the same surround effect produced by a multichannel system using the left and right speakers.

The Audio settings include the following options:

Option	Description
Sound Mode	Dynamic Select to enhance treble and bass.
	Standard Suitable for spoken dialog.
	Custom Flat setting.
Reset	Reset the following options to the default setting: Treble, Bass, Balance, Steady Sound, Volume Offset, Effect and BBE.
Treble	Adjust to increase or decrease higher-pitched sounds.
Bass	Adjust to increase or decrease lower-pitched sounds.
Balance	Adjust to emphasize left or right speaker balance.
Steady Sound	On Select to stabilize the volume across all programs and commercials.
	Off Select to turn off Steady Sound.
Volume Offset	Adjust to increase or decrease the sound level of the current input (TV or video input) relative to other inputs.
Effect	TruSurround XT Select for surround sound (for stereo programs only).
	Simulated Adds a surround-like effect to mono programs.
	 Simulated uses SRS 3D MONO.
	Off Normal stereo or mono reception.
BBE	Select to give sound more impact by compensating for phase effects in speakers. Select from High, Low, and Off.

Option	Description
MTS <i>Enjoy stereo, bilingual and mono programs</i>	Stereo Select for stereo reception when viewing a program broadcast in stereo.
	Auto SAP Select to automatically switch to second audio programs when a signal is received. (If no SAP signal is present, the TV remains in Stereo mode.)
	Mono Select for mono reception. (Use to reduce noise during weak stereo broadcasts.)
 MTS is available only for analog programs.	
Speaker	On Select to turn on the TV speakers.
	Off Select to turn off the TV speakers and listen to the TV's sound only through your external audio system speakers.
 The MUTING button on your remote control is available when Audio Out is set to Variable, and becomes nonfunctional when set to Fixed.	
Audio Out <i>Easy control of volume adjustments</i>	This option can be set only when the Speaker option is set to Off .
	Variable The TV's speakers are turned off and the audio output from your audio system can still be controlled by the TV's remote control.
	Fixed The TV's speakers are turned off, and the audio output of the TV is fixed. Use your audio receiver's volume control to adjust the volume (and other settings) through your audio system.
A/V Sync	Off/1/2/3 Use this option to make adjustments to audio and video synchronization when you have external equipment connected to DIGITAL AUDIO (OPTICAL) OUT of the TV. Select Off (factory default setting) to make no adjustments. Select 1, 2 or 3 to adjust so that the video and audio from your connected external equipment are in synchronized.

Selecting PC Audio Options

To display the PC screen:

Press TV/VIDEO repeatedly on the remote control until VIDEO 7 (PC) appears.

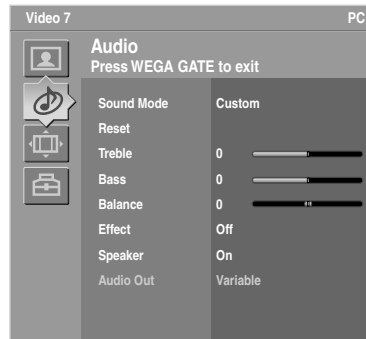

 You can change the settings for the PC input while the TV is displaying the PC screen.

The PC Input Audio setting includes the following options:

Option	Description
Sound Mode	Dynamic Select to enhance treble and bass.
	Standard Suitable for spoken dialog.
	Custom Flat setting.
Reset	Select to restore the factory default settings.
Treble	Adjust to increase or decrease higher-pitched sounds.
Bass	Adjust to increase or decrease lower-pitched sounds.
Balance	Adjust to emphasize left or right speaker balance.
Effect	TruSurround XT Select for surround sound (for stereo programs only).
	Simulated Adds a surround-like effect to mono programs.
	Off Normal stereo or mono reception.
Speaker	On Select to turn on the TV speakers.
	Off Select to turn off the TV speakers and listen to the TV's sound only through your external audio system speakers.
Audio Out	This option can be set only when the Speaker option is set to Off .
Easy control of volume adjustments	Variable The TV's speakers are turned off, but the audio output from your audio system can still be controlled by the TV's remote control.
	Fixed The TV's speakers are turned off and the audio output of the TV is fixed. Use your audio receiver's volume control to adjust the volume (and other settings) through your audio system.



Accessing the Screen Settings

1. Press WEGA GATE.....



2. Select Settings.....



3. Highlight.....



4. Press to select.....

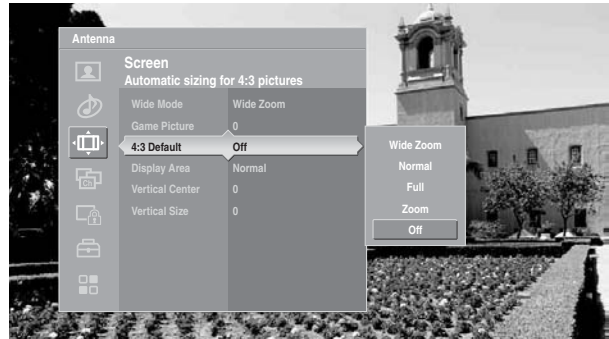

To highlight an option and to change settings, press \uparrow \downarrow \leftarrow \rightarrow .

Press \odot to confirm the selection.

To exit the Screen, press .

Selecting Screen Options

 Wide Mode is unavailable while in Freeze (page 54).

The Screen settings include the following options:

Option	Description
Wide Mode	Wide Zoom
<i>Select a screen mode to use for 4:3 sources.</i>	Select to enlarge the 4:3 picture, to fill the 16:9 screen, keeping the original image as much as possible.
	Normal
	Select to return the 4:3 picture to its original size and aspect ratio.
	 Normal is not available when you are watching 720p or 1080i sources.
	Full
	Select to enlarge the 4:3 picture horizontally only, to fill the display area.
	Zoom
	Select to proportionally enlarge 1080i and 720p sources. For 480p and 480i sources, Zoom will vertically stretch the image to fill the screen.

 **To change from one Wide Mode setting to another, use the WIDE button on the remote control (see page 53).**

Game Picture Allows you to move the position of the picture left and right in the window. (This feature also allows you to adjust the picture from any connected equipment.) Select while watching the picture to be adjusted. The TV stores the position in memory for each input. Press \leftarrow or \rightarrow and press \odot to choose a correction between +5 and -5.

 **Not available in Full and Normal mode when sources are in 720p or 1080i.**

(Continued)

Using the Settings

💡 If 4:3 Default is set to anything but Off, the Wide Mode setting changes only for the current channel. When you change channels (or inputs), Wide Mode is automatically replaced with the 4:3 Default setting. To retain the current Wide Mode setting as channels and inputs are changed, set 4:3 Default to Off.

Option	Description	
4:3 Default <i>Select the default screen mode to use for 4:3 sources.</i>	Wide Zoom	Select to enlarge the 4:3 picture, to fill the 16:9 screen, keeping the original image as much as possible.
	Normal	Select to return the 4:3 picture to normal mode.
	Full	Select to enlarge the 4:3 picture horizontally only, to fill the display area.
	Zoom	Select to enlarge the picture horizontally and vertically to an equal aspect ratio that fills the wide screen.
	Off	Select to continue using the current screen mode setting when the channel or input is changed.
Display Area	Select Normal to return to the default display area. Select -1 or -2 to keep the edge of the picture out of screen.	
Vertical Center	Allows you to move the position of the picture up and down in the window. (Available only in Zoom mode.) Press ▲ or ▼ and press ⊕ to choose a correction between +5 and -5.	
Vertical Size	Allows you to adjust the vertical size of the picture. (Available only in Zoom mode.) Press ▲ or ▼ and press ⊕ to choose a correction between +5 and -5.	

Selecting PC Screen Options

💡 When there is no signal input, all settings are not available.

To display the PC screen:

Press TV/VIDEO repeatedly on the remote control until VIDEO 7 (PC) appears.

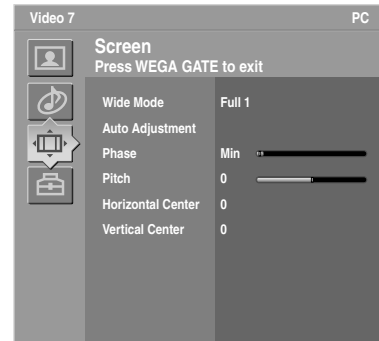

🔧 You can change the settings for the PC input while the TV is displaying the PC screen.





The PC Input Screen setting includes the following options:

💡 Select Zoom in the Wide Mode option to display movies and other content on DVD, using the entire viewable area of the screen.

Option	Description	
Wide Mode	Normal	Select to display the picture in its original size.
	Full 1	Select to enlarge the picture to fill the display area, keeping its original horizontal-to-vertical ratio.
	🔧 Full 2	Select to enlarge the picture to fill the display area.
	🔧 Full 2	A black frame will appear on the surrounding of the picture.
Zoom	Select to enlarge the picture horizontally and vertically to an equal aspect ratio that fills the wide screen.	
Auto Adjustment	Select to automatically adjust the display position of the picture when the TV receives an input signal from the connected PC. Note that Auto Adjustment may not work well with certain input signals. In such cases, manually adjust the options below.	
Phase	Select to adjust the phase when the screen flickers.	
Pitch	Select to adjust the pitch when the picture has unwanted vertical stripes.	
Horizontal Center	Select to adjust the horizontal position of the picture. Allows you to move the picture left and right in the window. Press ◀ or ▶ and press ⊕ to choose a correction between +50 and -50.	
🔧 Horizontal Center	The variable range depends on the signal.	
Vertical Center	Select to adjust the vertical position of the picture. Allows you to move the picture up and down in the window. Press ◀ or ▶ and press ⊕ to choose a correction between +50 and -50.	
🔧 Vertical Center	The variable range depends on the signal.	



Accessing the Channel Settings

1. Press WEGA GATE..... 
2. Select Settings..... 
3. Highlight..... 
4. Press to select..... 

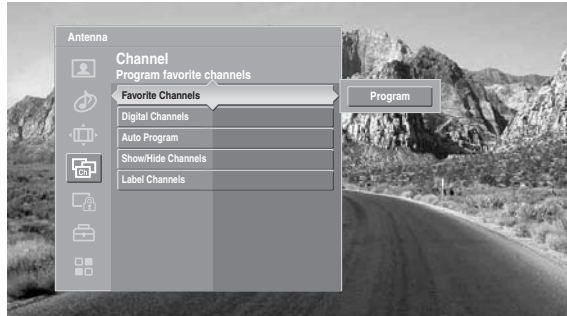

To highlight an option and to change settings, press **↑ ↓ ← →**.

Press **⊕** to confirm the selection.

To exit the Channel, press **WEGA GATE**.

Selecting Channel Options

 Channels that you set to Hidden can only be accessed with the 0-9 buttons.

The Channel settings include the following options:

Option	Description
Favorite Channels	Lets you set up a list of your favorite channels. For details, see “Using Favorites in WEGA GATE” on page 57.
Digital Channels Add	Select to add digital channels.
Auto Program	Automatically sets up the channel list on the TV for all receivable channels for the current input (VHF/UHF or CABLE). Select to start the Auto Program.  Auto Program may take up to 20 to 50 minutes to complete. A progress bar will display the approximate progress of the Auto Program and Digital Channels/Add sequences.
Show/Hide Channels	Allows you to show or hide channels that appear in the Program Guide and when you use the CH+/- buttons to channel surf. Channels that are set to Hidden do not appear in the Program Guide or when you use the CH+/- buttons. 1 Press ↑ or ↓ to highlight the channel that you want to show or hide. To move between the Major and Digital subchannel lists, press ← or → . 2 To change a channel’s setting to Shown or Hidden, press ⊕ . 3 To show or hide more channels, repeat steps 1 and 2.

Option	Description
✎	If you select to hide or show a major digital channel, all the sub-channels are automatically hidden or shown. To show or hide an individual sub-channel within a digital channel, you must individually select that sub-channel to show or hide.
✎	If you hide all sub-channels of a major digital channel, that digital channel is automatically set to Hidden.

- Label Channels** Allows you to assign labels (such as station call letters) to channel numbers.
- 1** Press **▲** or **▼** to scroll through the channel numbers. Then press **⊕** to select the channel number that you want to assign a label.
 - 2** Press **▲** or **▼** to scroll through the label characters (A-Z, 0-9, etc.). Then press **⊕** to select the highlighted character.
Repeat to add characters to the label.
 - 3** Press **◀** to return to the Channel setting, or press **WEGA GATE** to exit the settings.



Accessing the Parental Lock Settings

1. Press WEGA GATE.....



2. Select Settings.....



3. Highlight.....



4. Press to select.....

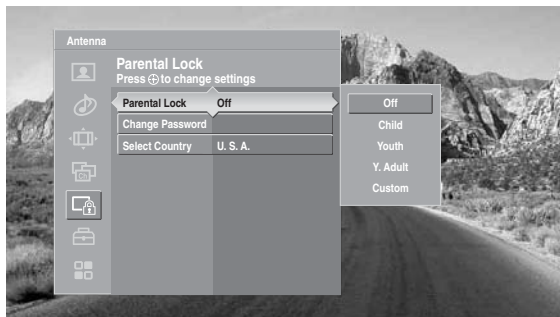

To highlight an option and to change settings, press **↑ ↓ ← →**.

Press **⊕** to confirm the selection.

To exit the Parental Lock, press **WEGA GATE**.

The Parental setting allows you to set up the TV to block programs according to their content and rating levels.





You need your password for any future access to the Parental Lock settings. If you have lost your password, see “Lost password” on page 93.

Selecting Parental Lock Options

The Parental Lock settings include the following options:

Option	Description										
Parental Lock <i>Turn ratings on/off and select a rating system</i>	<table border="0"> <tr> <td>Off</td> <td>Turn Parental Lock off. No programs are blocked from viewing.</td> </tr> <tr> <td>Child</td> <td>Maximum ratings permitted are: U.S.: TV-Y, TV-G, G Canada: C, G, TV-Y</td> </tr> <tr> <td>Youth</td> <td>Maximum ratings permitted are: U.S.: TV-PG, PG Canada: C8+, PG, 8 ans+, TV-PG</td> </tr> <tr> <td>Y. Adult</td> <td>Maximum ratings permitted are: U.S.: TV-14, PG-13 Canada: 14+, 13 ans+, TV-14</td> </tr> <tr> <td>Custom</td> <td>Select to set ratings manually. U.S.: See page 76 for details. Canada: See page 77 for details.</td> </tr> </table>	Off	Turn Parental Lock off. No programs are blocked from viewing.	Child	Maximum ratings permitted are: U.S.: TV-Y, TV-G, G Canada: C, G, TV-Y	Youth	Maximum ratings permitted are: U.S.: TV-PG, PG Canada: C8+, PG, 8 ans+, TV-PG	Y. Adult	Maximum ratings permitted are: U.S.: TV-14, PG-13 Canada: 14+, 13 ans+, TV-14	Custom	Select to set ratings manually. U.S.: See page 76 for details. Canada: See page 77 for details.
Off	Turn Parental Lock off. No programs are blocked from viewing.										
Child	Maximum ratings permitted are: U.S.: TV-Y, TV-G, G Canada: C, G, TV-Y										
Youth	Maximum ratings permitted are: U.S.: TV-PG, PG Canada: C8+, PG, 8 ans+, TV-PG										
Y. Adult	Maximum ratings permitted are: U.S.: TV-14, PG-13 Canada: 14+, 13 ans+, TV-14										
Custom	Select to set ratings manually. U.S.: See page 76 for details. Canada: See page 77 for details.										

 If you are not familiar with the Parental Guideline rating system, you should select Child, Youth, or Y.Adult to help simplify the rating selection. To set more restrictive ratings, select Custom.

 For descriptions of Child, Youth, and Y.Adult ratings, see page 74.

<i>Option</i>	<i>Description</i>
Change Password	Select to change your password.
Select Country	U.S.A. Select to use USA ratings (see page 76).
	Canada Select to use Canadian ratings (see page 77).

To deactivate the parental control feature

- Set Parental Lock to OFF when in the Parental Lock setting.

To change the password

- 1** In the Parental Lock setting, use the arrow buttons to highlight Change Password, and press  to select it.
- 2** Enter a new four-digit password using the 0-9 buttons.
- 3** Confirm the new password by entering it again.
- 4** Press WEGA GATE to exit the setting screen.

Viewing Blocked Programs

You can view a blocked program by entering the password.

- 1** Press ENT when tuned to a blocked program.
- 2** Enter your password using the 0-9 buttons. Parental control will be canceled temporarily until you turn your TV off.

Selecting Custom Rating Options

💡 To ensure maximum blocking capability, the age-based ratings should be blocked.

💡 If you select Block, be aware that the following programs may be blocked: news, sports, weather, emergency broadcasts, political programs, public service announcements, and religious programs.

US custom rating options

If you selected U.S.A. as the country of residence on page 75, the Custom Rating setting includes the following options. (If you selected Canada, see page 77.)

Option	Description
Movie Rating	G All children and general audiences.
	PG Parental guidance suggested.
	PG-13 Parental guidance for children under 13.
	R Restricted viewing, parental guidance is suggested for children under 17.
	NC-17 and X No one 17 and under.
TV Rating <i>Block programs by their rating, content or both</i>	Age-Based Options
	TV-Y All children.
	TV-Y7 Directed to children age 7 and older.
	TV-G General audience.
	TV-PG Parental guidance suggested.
	TV-14 Parents strongly cautioned.
	TV-MA Mature audience only.
	Content-Based Options
	FV Fantasy violence.
	D Suggestive dialog.
	L Strong language.
	S Sexual situations.
	V Violence.
	Unrated <i>Block programs or movies that are broadcast without a rating</i>
Block Blocks all programs and movies that are broadcast without a rating.	

 **The content ratings will increase depending on the level of the age-based rating. For example, a program with a TV-PG V (Violence) rating may contain moderate violence, while a TV-14 V (Violence) rating may contain more intense violence.**

Canadian custom rating options

If you selected **Canada** as the country of residence on page 75, the Custom Rating setting includes the following options. (If you selected **U.S.A.**, see page 76.)

<i>Option</i>	<i>Description</i>	
English Rating	C	All children.
	C8+	Children 8 years and older.
	G	General programming.
	PG	Parental guidance.
	14+	Viewers 14 and older.
	18+	Adult programming.
French Rating	G	General programming.
	8 ans+	Not recommended for ages under 8.
	13 ans+	Not recommended for ages under 13.
	16 ans+	Not recommended for ages under 16.
	18 ans+	Programming restricted to adults.
U.S.A. Rating	See “TV Rating” on page 76 for details.	

Accessing the Setup Settings

1. Press WEGA GATE.....



2. Select Settings.....



3. Highlight.....



4. Press to select.....

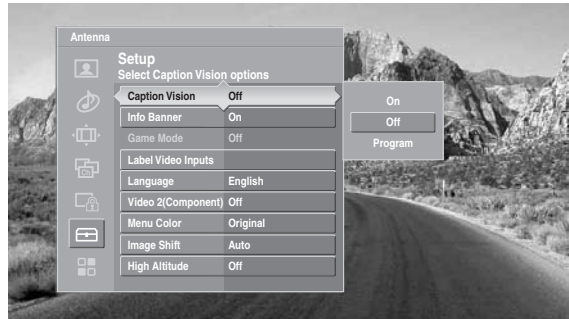

To highlight an option and to change settings, press **▲ ▼ ◀ ▶**.



Press **⊕** to confirm the selection.

To exit the Setup, press **WEGA GATE**.

Selecting Setup Options

The Setup settings include the following options:

Option	Description	
Caption Vision	Allows you to select from four closed caption modes (for programs that are broadcast with closed captioning).	
	On	Caption Vision is turned on.
	Off	Caption Vision is turned off.
Program	Allows you to set basic and advanced Caption Vision options. See “Programming Caption Vision” on page 80.	
Info Banner	Set to On or Off. Select On to display the program name, time remaining and other information (if the broadcaster offers this service). Also displays when the channel is changed or the DISPLAY button is pressed.	
Game Mode	On	Select to optimize the lipsync when playing games.
	Off	Select to turn off the Game Mode.

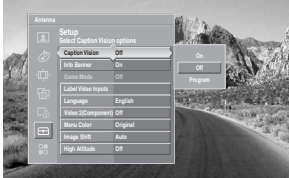
Option	Description
Label Video Inputs	<p>Allows you to label the audio/video equipment you have connected to the TV so you can identify them when using TV/VIDEO. When in this setting:</p> <ol style="list-style-type: none"> 1 Press ▲ or ▼ to highlight an input to label, then press ⊕ to select it. 2 Use the arrow buttons to scroll through the labels. 3 Press ⊕ to select the equipment you connected to each of the input jacks on the back of your TV. <p>Select Skip if you do not have any equipment connected to a particular input.</p>
Video 1-6	Video 1-6, VHS, DVD, Receiver, Satellite, Cable Box, 8mm, DTV, Game, LD, Beta, HD, DVR, Camcorder, Skip
Video 7	Video 7, PC, DVD, HD, Game, Skip
<p> If you select Skip, your TV skips the selected connection when you press TV/VIDEO.</p>	
Language	Select to display all on-screen settings in your language of choice: English, Español, Français.
Video 2 (Component)	<p>Auto Select to switch automatically between the component video jacks (Y Pb/Cb Pr/CR, AUDIO L (MONO)/AUDIO R) and the composite video jacks (VIDEO, AUDIO L (MONO)/AUDIO R) on the left side of the TV (VIDEO/HD/DVD 2 IN) depending on the cable connection.</p> <p>Off Select to activate the composite video jacks (VIDEO/AUDIO L(MONO)/AUDIO R) on the left side of the TV.</p>
Menu Color	Enables you to select a specific color for the on-screen settings.
Image Shift	<p>Corrects the image on your TV.</p> <p>Before adjusting After adjusting</p> <div style="display: flex; justify-content: space-around;">   </div> <p>Auto (Factory setting) Automatically corrects double images.</p> <p>Level 1-4 Select a level from 1-4 to align the images and improve the picture.</p>

 If you use the composite connection when Video 2 (Component) is set to Auto, do not connect the component cable at the same time. Otherwise select Off.

(Continued)

Option	Description
High Altitude	Select On to use the TV at an altitude of 5,000 feet (1,500 m) or higher. Select Off to use the TV at normal altitude.
CineMotion	Select Auto to optimize the screen display automatically detecting film content and applying a reverse 3-2 pulldown process. Moving picture will appear clearer and more natural looking. Select Off to disable the detection.

Programming Caption Vision

If you selected the Program option under Caption Vision (see page 78), you can change the following settings:

Option	Description
Basic	Allows you to select basic analog (EIA-608) closed caption options.
	CC1, CC2, CC3, CC4 Displays a printed version of the dialog or sound effects of a program. (Should be set to CC1 for most programs.)
	Text1, Text2, Text3, Text4 Displays network/station information presented using either half or the whole screen (if available).
Digital CC	Allows you to set digital closed captioning to Basic (digital EIA-608) or Advanced (digital EIA-708).
Advanced	Allows you to select advanced digital (EIA-708) closed caption options. Select from the available options.
Advanced Settings	Allows you to make additional settings for digital (EIA-708) closed caption options. Select from As Broadcast , Small Text , Large Text and Custom .
	Custom Allows you to customize the following settings:
	Character Size Small, Standard, Large
	Character Style Style 1-7
	Character Color Color 1-8
	Character Opacity Solid, Translucent
	Edge Color Color 1-8
	Edge Type None, Raised, Depressed, Outline, Left Shadow, Right Shadow
	Background Color None, Color 1-8
	Background Opacity Solid, Translucent
	Window Color None, Color 1-8
	Window Opacity Solid, Translucent

Selecting PC Setup Options

To display the PC screen:

Press TV/VIDEO repeatedly on the remote control until VIDEO 7 (PC) appears.

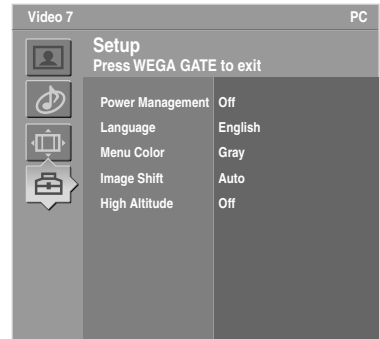

 You can change the settings for the PC input while the TV is displaying the PC screen.

The PC Input Setup setting includes the following options:

Option	Description
Power Management	On Select to automatically switch to the Power Saving mode when there is no signal input for 10 minutes.
	Off Select to turn off Power Management.
Language	Select to display all on-screen settings in your language of choice: English, Español, Français.
Menu Color	Enables you to select a specific color for the on-screen settings from Original, Gray, Red, Green and Purple.
Image Shift	Auto (Factory setting) Automatically corrects double images.
	Level 1-4 Select a level from 1-4 to align the images and improve the picture.
High Altitude	Select On to use the TV at an altitude of 5,000 feet (1,500 m) or higher. Select Off to use the TV at normal altitude.





Using the Settings

PC Input Signal Compatibility Chart

Resolution				Horizontal frequency (kHz)	Vertical frequency (Hz)	VESA standard
Signals	Horizontal (Dot)	×	Vertical (Line)			
VGA	640	×	480	31.5	60	—*
	640	×	480	37.5	75	✓
	640	×	480	43.3	85	✓
	720	×	400	31.5	70	—*
SVGA	800	×	600	35.2	56	✓
	800	×	600	37.9	60	✓
	800	×	600	46.9	75	✓
	800	×	600	48.1	72	✓
XGA**	1024	×	768	48.4	60	✓
	1024	×	768	56.5	70	✓
	1024	×	768	60	75	✓
WXGA**	1280	×	768	47.4	60	✓
	1280	×	768	47.8	60	✓

*: Corresponding to the VGA signal

** : These signals do not support Normal display mode.

-  **This TV does not support Sync on Green or Composite Sync.**
-  **If a signal other than in the above chart is input, it may not be displayed properly or may not be displayed as you set.**
-  **Using the Vertical frequency (Hz) of the personal computer at 60 is recommended.**
-  **Noise may be detected under certain conditions. If unsupported signals are used, you will see the message, “Unsupported Signal”.**



Accessing the Applications Settings

1. Press WEGA GATE.....



2. Select Settings.....



3. Highlight.....



4. Press to select.....

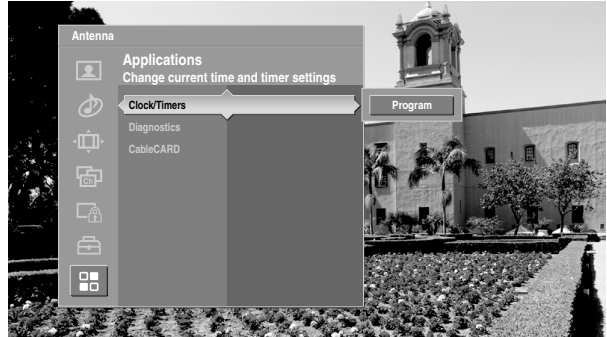

To highlight an option and to change settings, press \uparrow \downarrow \leftarrow \rightarrow .

Press \oplus to confirm the selection.

To exit the Applications, press WEGA GATE .

Selecting Applications Options

The Applications settings include the following options:

Option	Description
Clock/Timers	Select to set the clock and to program your TV to turn on and off at two scheduled viewing times. Once the options are set, TIMER LED lights up in red.
Sleep	Allows you to select the amount of time (Off, 15 minutes, 30 minutes, 45 minutes, 60 minutes or 90 minutes) that you want the TV to remain on before shutting off automatically.
Timer 1 Timer 2	You can use the Timers to program the TV to turn on and off and tune to a specific channel at two scheduled viewing times.

Timer 1 and Timer 2 cannot be set until you set the Current Time.

1 Press \uparrow or \downarrow to highlight Timer 1 or Timer 2. To set the timer, press \rightarrow .

To go directly to programming Timer 1 or 2, press \oplus instead of pressing \rightarrow .

(Continued)

<i>Option</i>	<i>Description</i>
	<p>2 Press ▲ or ▼ to highlight one of the following options, then press ⊕.</p> <p>Program Select to set the Timer by day, time, duration, and channel.</p> <p>Off Select to turn off the Timer. (Your previous settings are saved.)</p>
	<p>3 If you selected Program in step 2, press ▲ and ▼ to set the day(s), hour, minute, AM/PM, duration, and channel number. Press ⊕ or press ▶ to confirm each setting and move to the next setting. Press ◀ to go back to the previous setting.</p>
	<p>4 Press WEGA GATE to exit the setting screen. An LED on the front panel will light, indicating the Timer has been set.</p>
Current Time	You can set the current time.
	<p>1 Press ⊕ to select Current Time.</p> <p>2 Press ▲ and ▼ to set the current time (day, hour, minute, and AM/PM). Press ⊕ (or press ▶) to confirm each setting and move to the next setting. Press ◀ to go back the previous setting.</p> <p>3 Press WEGA GATE to exit the setting screen.</p>
Diagnostics	Display diagnostics information about the TV. This can be useful in providing information to an authorized technician or repair person.
CableCARD	This list of selectable CableCARD options will vary, depending on your cable service provider.

Other Information

Overview

This chapter includes the following topics:

<i>Topic</i>	<i>Page</i>
Contacting Sony	85
Replacing the Lamp	86
Troubleshooting	90
Specifications	94
Optional accessories	95
Index	96

Contacting Sony

If, after reading these operating instructions, you have additional questions related to the use of your Sony television, please call our Customer Information Services Center.

For US residents: 1-800-222-SONY (7669)

or visit: <http://www.sonystyle.com/tv/>

For Canadian residents: 1-877-899-SONY (7669)

or visit: <http://www.sonystyle.ca/tv/>

Before calling Sony customer support, please write down the model and serial numbers of your TV. You'll find this information on the front cover of this manual.

Replacing the Lamp

The projection lamp, which illuminates the picture, has a limited life.

If the screen becomes dark, the color looks unusual, or the LAMP indicator on the front of the TV flashes, it is time to replace the lamp with a new one (not supplied).



WARNING

Electric appliances can cause fire or high temperature, resulting in injury or death. Be sure to follow the instructions below.

- Use a Sony XL-2400 replacement lamp (not supplied) for replacement. Use of any other lamp may damage the TV.
- Do not remove the lamp for any purpose other than replacement. Doing so may cause injury or fire.
- Do not put flammable materials and metal objects inside the lamp receptacle of the TV after removing the lamp. Doing so may cause fire or electrical shock. Do not touch the lamp receptacle once the lamp has been removed.
- When the lamp eventually burns out, you may hear a noticeable pop sound. This is normal and it is inherent to this type of lamp.
- In rare instances, the bulb may pop inside the lamp unit, but the lamp unit is designed to contain all of the broken glass pieces inside the lamp unit.
- The lamps contain mercury. For proper disposal of the used lamps, follow and observe the local ordinances. See page 89.

How to Replace the Lamp

- 1** Turn off the power on the main unit. Wait several minutes, then unplug the power cord.
(The cooling fan will continue to operate for about two minutes after turning the power off.)
- 2** Wait at least 30 minutes after unplugging the power cord to allow the lamp to cool down before replacing it. To avoid being burned, do not touch the lamp receptacle once the lamp has been removed.
- 3** Take the new lamp out of the box.
Do not touch the glass portion of the new lamp.



Do not shake the lamp. Vibration can damage the lamp or shorten its life.



Avoid touching the front glass of a new lamp or the glass of the lamp receptacle. This may reduce picture quality or lamp life.

- 4** Remove the outside lamp cover.

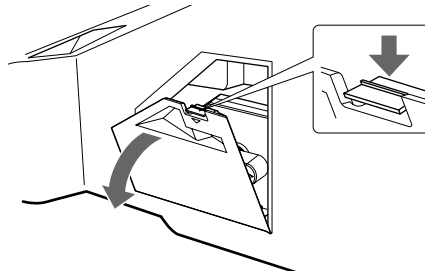

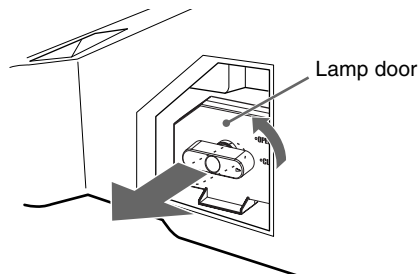

- 5** Remove the lamp door.
Turn the knob counterclockwise to OPEN and pull out the cover.

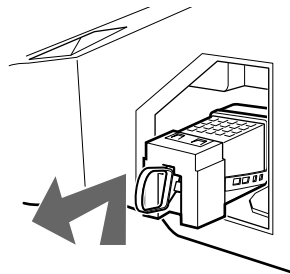

- 6** Pull out the lamp.
Hook a finger through the loop of the lamp handle and pull the handle upwards. Then pull the lamp straight out.



-  **The lamp is very hot immediately after use. Never touch the glass portion of the lamp or the surrounding parts.**
-  **After the used lamp has cooled, place it into the empty box of the replacement lamp. Never put the used lamp into a plastic bag.**

(Continued)

- 7** Put the new lamp into its place.
Mount the new lamp securely. Failure to do so may cause a fire or the screen to go dark.

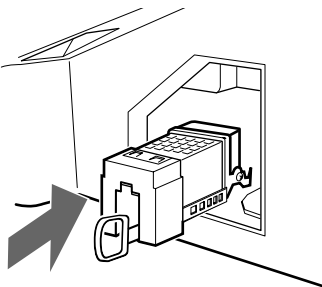

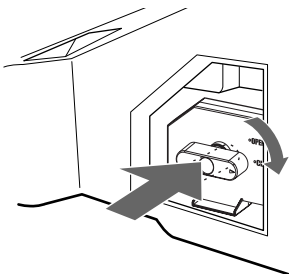

 **If the lamp is not securely reattached, the self-diagnostic function may be triggered and the POWER/STANDBY indicator flashes three times (see page 12).**

- 8** Reattach the lamp door.
Turn the knob back to CLOSE and secure the cover.

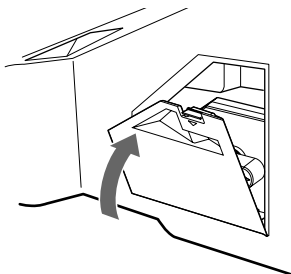

- 9** Put the outside lamp cover back in its place.



 **Consult your Sony dealer for a Sony XL-2400 replacement lamp.**

 **Take great care when replacing the lamp or plugging in/unplugging the connecting cords. Rough handling may cause the TV to fall, damaging the TV, the TV stand and the floor.**

The used lamp

This product contains mercury. Disposal of this product may be regulated if sold in the United States. For disposal or recycling information, please contact your local authorities or the Electronics Industries Alliance (<http://www.eiae.org>).

- Do not leave the used lamp near flammable materials or within the reach of children.
- Do not pour water onto the used lamp or put any object inside the lamp. Doing so may cause the lamp to burst.

**For replacement lamp information visit:
U. S. residents: <http://www.sonystyle.com/tv/>
Canadian residents: <http://www.sonystyle.ca/tv/>**

Troubleshooting

Remote Control

Problem	Possible Remedies
Remote control does not operate	<ul style="list-style-type: none"><input type="checkbox"/> The batteries could be weak. Replace the batteries.<input type="checkbox"/> Check the orientation of the batteries.<input type="checkbox"/> Press TV (FUNCTION) once, and the TV indicator lights up. You may have inadvertently pressed SAT/CABLE (FUNCTION), which changes the remote control to SAT or CABLE mode.<input type="checkbox"/> Make sure this unit's power cord is connected securely to the wall outlet.<input type="checkbox"/> Install the unit at least 3-4 feet away from fluorescent lights.<input type="checkbox"/> If the "High Temperature Warning!" message appears, turn off the TV and wait until the TV's projection lamp cools down (approximately 5 minutes). If the remote control still does not work, make sure to dust the ventilation slots on the rear of the TV and the cooling fan to provide adequate ventilation around the TV.
Cannot change channels with the remote control	<ul style="list-style-type: none"><input type="checkbox"/> If you are using the TV to change channels, first press TV (FUNCTION) once, and the TV indicator lights up.<input type="checkbox"/> If you are using another device to change channels, be sure you have not inadvertently switched your TV from the channel 3 or 4 setting.<input type="checkbox"/> If you are using another device to change channels, be sure to press FUNCTION for that device. For example, if you are using your cable box to change channels, be sure to press SAT/CABLE (FUNCTION) once, and the SAT/CABLE indicator lights up.
Remote control does not operate non-Sony video equipment	<ul style="list-style-type: none"><input type="checkbox"/> If you replaced the batteries to the remote recently, the code numbers for the video equipment may need to be reset.<input type="checkbox"/> There may be more than one code for the equipment that you are attempting to operate.<input type="checkbox"/> There is a possibility that some non-Sony equipment cannot be operated by your Sony TV remote. You may need to use the equipment's original remote control.

CableCARD Device

Problem	Possible Remedies
Problems using CableCARD device or CableCARD services	<ul style="list-style-type: none"><input type="checkbox"/> Check that the CableCARD is inserted properly (see pages 30-31).<input type="checkbox"/> The CableCARD device must be activated by your local cable TV provider before you can receive digital cable TV services. See the activation instructions on pages 30-31.<input type="checkbox"/> Check the Diagnostics and CableCARD setting options (see page 84). (This can be useful in providing information to an authorized technician or repair person.)<input type="checkbox"/> Contact your cable TV provider.

Video

Problem	Possible Remedies
No picture (screen not lit), no sound	<ul style="list-style-type: none"> <input type="checkbox"/> If your TV does not turn on and a red light keeps flashing, your TV may need service. Call your local Sony Service Center. <input type="checkbox"/> Make sure the power cord is plugged in. <input type="checkbox"/> Press POWER on the front of the TV. <input type="checkbox"/> Press TV/VIDEO to cycle through the connected video sources. <input type="checkbox"/> Try another channel; it could be station trouble.
Dark, poor or no picture (screen lit), good sound	<ul style="list-style-type: none"> <input type="checkbox"/> Adjust the Picture Mode option in the Video setting (see page 63). <input type="checkbox"/> Adjust the Brightness option in the Video setting (see page 63). <input type="checkbox"/> Check the antenna/cable connections.
No color/dark picture/color is not correct	<ul style="list-style-type: none"> <input type="checkbox"/> Adjust the Color option in the Video setting (see page 63).
Only snow and noise appear on the screen	<ul style="list-style-type: none"> <input type="checkbox"/> Check the antenna/cable connections. <input type="checkbox"/> Try another channel; it could be station trouble. <input type="checkbox"/> Press ANT to change the input mode (see page 44).
Dotted lines or stripes	<ul style="list-style-type: none"> <input type="checkbox"/> Adjust the antenna. <input type="checkbox"/> Move the TV away from noise sources such as cars, neon signs, or hair dryers.
Double images	<ul style="list-style-type: none"> <input type="checkbox"/> Using a highly directional outdoor antenna or a cable may solve the problem. <input type="checkbox"/> Set Image Shift to an appropriate value. The default setting is Auto. If doubled images appear with Auto, select the best value from 1 to 4 (see page 79).
"Black box" on screen	<ul style="list-style-type: none"> <input type="checkbox"/> You have selected a text option in the Setup setting and no text is available. (See page 78 to reset Setup selections.) To turn off this feature, set the Caption Vision option to Off. If you were trying to select closed captioning, select CC1 instead of Text 1-4.
Black bands appear at the top and bottom of the screen	<ul style="list-style-type: none"> <input type="checkbox"/> Some wide-screen programs are filmed in aspect ratios that are greater than 16:9 (this is especially common with theatrical releases). Your TV will show these programs with black bands at the top and bottom of the screen. For more details, check the documentation that came with your DVD (or contact your program provider).
Certain programs on DVD or other digital sources display a loss of detail, especially during fast-motion or dark scenes	<ul style="list-style-type: none"> <input type="checkbox"/> The compression used by certain digital broadcasts and DVDs may cause your TV's screen to display less detail than usual, or cause artifacts (small blocks or dots, pixelations) to appear on your screen. This is due to your TV's large screen and ability to show very fine detail, and is normal for certain digitally recorded programs. Adjust the reality/clarity in the DRC Palette setting (see page 64) to optimize the picture while viewing these sources.
"Iris Unit error" appears while Advanced Iris is active	<ul style="list-style-type: none"> <input type="checkbox"/> The Iris Control may have a problem. Call your local Sony Service Center.

Audio

Problem	Possible Remedies
Good picture, no sound	<ul style="list-style-type: none"><input type="checkbox"/> Press MUTING so that Muting disappears from the screen (see page 44).<input type="checkbox"/> Make sure the Speaker option is set to On in the Audio setting (see page 67).<input type="checkbox"/> Make sure the MTS option is set to Stereo or Mono (see page 67).<input type="checkbox"/> When the HDMI IN input is in use, surround sound, such as AC-3 and DTS, cannot be input. Change the sound setting for the external input device to Linear PCM.
Audio noise	<ul style="list-style-type: none"><input type="checkbox"/> Communication problems may occur if infrared communication equipment (e.g., infrared cordless headphones) is used near the TV. Use headphones other than infrared cordless headphones. Also, if you use infrared communication equipment other than infrared cordless headphones, move the infrared transceiver away from the TV until the noise is eliminated, or move the transmitter and receiver of the infrared communication equipment closer together.
Cannot gain enough volume when using a cable box	<ul style="list-style-type: none"><input type="checkbox"/> Increase the volume of the cable box using the cable box's remote control. Then press TV(FUNCTION) once (the TV indicator lights up) and adjust the TV's volume.
Sound seems weak or insufficient	<ul style="list-style-type: none"><input type="checkbox"/> The TV's audio might be set to Auto SAP or Mono, when it might be better set to Stereo. In the Audio setting (see page 67), set the MTS setting to Stereo. If already set to Stereo, switch to Mono (which may reduce background noise during weak stereo broadcasts).
Cannot raise the volume on external speakers	<ul style="list-style-type: none"><input type="checkbox"/> If the Speaker option is set to Off and the Audio Out option is set to Fixed (in order to output the sound to your audio system), use your audio receiver to adjust the sound (see page 67). Or, to use the TV remote control, set the Audio Out option to Variable.<input type="checkbox"/> To turn on the TV speakers, set the Speaker option to On (see page 67).

Channels

Problem	Possible Remedies
Cannot receive upper channels (UHF) when using an antenna	<ul style="list-style-type: none"><input type="checkbox"/> Press ANT to select the VHF/UHF input (see page 44).<input type="checkbox"/> Use Auto Program in the Channel setting to add receivable channels that are not presently in the TV's memory (see page 72).
Cannot receive any channels when using cable TV	<ul style="list-style-type: none"><input type="checkbox"/> Use Auto Program in the Channel setting to add receivable channels that are not presently in the TV's memory (see page 72).<input type="checkbox"/> Press ANT to select the CABLE input (see page 44).
Cannot receive or select channels	<ul style="list-style-type: none"><input type="checkbox"/> Use Auto Program in the Channel setting to add receivable channels that are not presently in TV memory (see page 72).
Some digital cable channels are not being displayed	<ul style="list-style-type: none"><input type="checkbox"/> Certain cable companies have limitations on the broadcast of digital cable channels. Check with your cable company for more information.<input type="checkbox"/> The digital cable channel may be set to Hidden in the Channel setting (see page 72).

General

Problem	Possible Remedies
How to reset TV to factory settings	<input type="checkbox"/> Turn on the TV. While holding down the ↑ button on the remote control, press the POWER button on the TV. (The TV will turn itself off, then back on again.) Release the ↑ button. WARNING: The Factory Reset will clear all of your customized settings including Parental Lock setting.
How to restore Video settings to factory settings	<input type="checkbox"/> Select Reset setting option while in the Video setting (see page 66).
How to restore Audio settings to factory settings	<input type="checkbox"/> Select Reset setting option while in the Audio setting (see page 66).
Cannot cycle through the other video equipment connected to the TV	<input type="checkbox"/> Be sure the Label Video Inputs option is not set to Skip (see page 79).
Cannot operate the setting	<input type="checkbox"/> If a setting option appears in gray, this indicates that the setting option is not available.
Lost password	<input type="checkbox"/> On the password screen (see page 74), enter the following master password: 4357. The master password clears your previous password; it cannot be used to temporarily unblock channels.
TIMER LED on front panel is lit	<input type="checkbox"/> When lit, indicates that the timer is set (see page 83). When the timer is set, this LED will remain lit even when the TV is turned off.
LAMP LED blinks in red	<input type="checkbox"/> Replace the lamp (see page 86).
Digital cable box does not work	<input type="checkbox"/> If you are connecting a VCR and digital cable box using a splitter, as described on page 35, you must use a special bi-directional splitter that is designed to work with your digital cable box. Contact your cable provider for details.
Cannot record digital channels to VCR	<input type="checkbox"/> Only analog channels can be recorded to your VCR.
TV cabinet creaks	<input type="checkbox"/> When the TV is in use, there is a natural rise in temperature, causing the cabinet to expand or contract and may be accompanied by a slight creaking noise. This is not a malfunction.
A slight creaking noise occurs from the bottom part of the TV	<input type="checkbox"/> Advanced Iris applies a mechanical iris system. When Advanced Iris is set, a natural creaking noise occurs due to the basic structure of the optical unit. The creaking sound is an inherent nature of this system and is not a defect.
The cooling fan is loud	<input type="checkbox"/> If the TV is used at high altitudes and High Altitude is set to On , the cooling fan runs faster and its sound becomes louder. If the TV is not used at high altitudes, set High Altitude to Off (see page 81).
"High Temperature Warning!" appears	<input type="checkbox"/> Make sure to remove dust from the ventilation slots on the rear and both sides of the TV. In addition, make sure that there are no obstacles in front of the ventilation slots. If the message still appears after the dust or obstacles are removed, the TV may need servicing. Call your local Sony Service Center.
The TV does not turn on	<input type="checkbox"/> The TV cools down its projection lamp when the power is turned off. It takes up to two minutes for the picture to come back after the TV is turned on again. Wait for a while until the picture comes back.

Other Information

Specifications

Projection System	3 LCD Panels, 1 lens projection system	
LCD Panel	0.73 inch TFT LCD panel (1,280 × 720 pixels)	
Projection Lens	High Performance, large diameter hybrid lens F2.4	
Antenna	75-ohm external terminal for VHF/UHF	
Lamp	100W, XL-2400	
Television System	NTSC	American TV Standard
	ATSC (8VSB terrestrial)	ATSC compliant 8VSB
	QAM on cable	ANSI/SCTE 07 2000
Visible Screen Size (Picture measured diagonally)	KDF-E42A10: 42 inches	
	KDF-E50A10: 50 inches	
Channel Coverage	Terrestrial (analog)	2-69
	Cable TV (analog)	1-125
	Terrestrial (digital)	2-69
	Cable TV (digital)	1-135
Number of Inputs/Outputs		
HDMI IN	Video	1080i, 720p, 480p, 480i
	Audio	Two channel linear PCM 32, 44.1 and 48 kHz, 16, 20 and 24 bit
Video (IN)	3 total (1 on side panel)	1 Vp-p, 75 ohms unbalanced, sync negative
S Video (IN)	1	Y: 1 Vp-p, 75 ohms unbalanced, sync negative
		C: 0.286 Vp-p (Burst signal), 75 ohms
Audio (IN)	5 total (1 on side panel)	500 mVrms (100% modulation) Impedance: 47 kilohms
Component Video Input	2 (Y P _B /C _B P _R /C _R)	Y: 1 Vp-p, 75 ohms unbalanced, sync negative
		P _B /C _B : 0.7 Vp-p, 75 ohms
		P _R /C _R : 0.7 Vp-p, 75 ohms
AUDIO (VAR/FIX) OUT	1	500 mVrms at the maximum volume setting (Variable) 500 mVrms (Fixed) Impedance (output): 2 kilohms
 AUDIO OUT jacks are operable only when the TV's Speaker is set to Off.		
RF Inputs	2	
PC Input	1	
Digital Audio Optical Output (PCM/Dolby Digital)	1	Optical Rectangular (1)
CableCARD Slot	PCMCIA Type I/II	
Speaker output	12 W + 12 W	
Power requirement	120 V, 60 Hz	
Power consumption	In use: 210 W	
	In standby: Less than 17 W	

Dimensions (W/H/D)	KDF-E42A10: 999 × 722 × 357 mm (39 ³ / ₈ × 28 ¹ / ₂ × 14 ¹ / ₈ inches) KDF-E50A10: 1184 × 827 × 408 mm (46 ⁵ / ₈ × 32 ⁵ / ₈ × 16 ¹ / ₈ inches)
Mass	KDF-E42A10: 28 kg (61 lb. 12 oz.) KDF-E50A10: 33 kg (72 lb. 13 oz.)
Supplied Accessories	
Remote Control	RM-YD003
AA (R6) Batteries	2 supplied for remote control
Operating Instructions	1
Quick Setup Guide	1
Warranty Card	1
Product Registration Card	1

Optional accessories:

- HDMI cable
- HDMI-to-DVI cable
- Component video cable
- S VIDEO cable
- A/V cable
- Audio cable
- Optical cable
- TV Stand : (SU-RG11S for KDF-E42A10, SU-RG11M for KDF-E50A10)
- Theatre Stand System: RHT-G2000
- Lamp : XL-2400

 **The availability of optional accessories depends on stock.**

Design and specifications are subject to change without notice.
Non-metric weights and measures are approximate.

Index

- 0-9 buttons 44
- 4:3 Default 70
- 5.1 Channel DVD using with remote control 50

A

- A/V Sync 67
- About Using CableCARD Device 30
- AC IN 18
- Adding channels to the channel list 72
- Adjusting audio, Steady Sound 66
- Advanced Iris 63
- Advanced Video 65
- Alternate Audio 52
- Alternate Video 52
- ANT button 44
- Applications Settings 62, 83
- Audio Out 67, 68
- AUDIO OUT jack, described 18
- Audio receiver, connecting 42
- Audio settings 61, 66
- Auto Adjustment 71
- Auto Program 72

B

- Balance, adjusting 66, 68
- Bass, adjusting 66, 68
- Batteries, inserting in remote 43
- BBE 66
- Brightness, adjusting 63, 65

C

- Cable
 - connecting with VCR 34
 - using with remote control 49
- Cable Box
 - connecting with VCR 35
- CableCARD device 30, 84
- CableCARD slot 17

- Camcorder connection 41
- Caption Vision 78
 - programming 80
- Change Password 75
- CHANNEL +/- button 15
- Channel settings 62, 72
- Channel Show/Hide 72
- Channels
 - Auto Program 72
 - creating labels 73
- CineMotion 9, 80
- Clear White 65
- Clock/Timers 83
- Closed caption modes 78
- Color Temp., adjusting 64, 65
- Color, adjusting 63
- Connecting
 - Audio receiver 42
 - Cable box 23–24
 - Camcorder 41
 - DVD player 38–39
 - Personal Computer 40
 - Satellite receiver 25
 - VCR 34–37

D

- Diagnostics 84
- DIGITAL AUDIO (OPTICAL) OUT 18
- Digital Channels 72
- Digital subchannels 52
- Display Area 70
- DISPLAY button 45
- Display Mode 65
- Display, turning off 45
- DRC Mode 64
- DRC Palette 64
- DVD player
 - using with remote control 49
 - with A/V connectors, connecting 39
 - with component video connectors, connecting 38

E

- Effect 66, 68
- English Rating 77
- ENT button 44
- External Inputs, WEGA GATE 56, 59

F

- Favorite Channels
 - setting up 72
- Favorites, WEGA GATE 56, 57
- FREEZE button 45, 54
- French Rating 77
- FUNCTION button 44

G

- Game Picture 69
- Gamma 65
- GUIDE button 51
- Guide menu 52

H

- HD/DVD IN jack (1080i/720p/480p/480i), described 16, 18
- HDMI IN jack, described 17
- High Altitude 80, 81
- High-Definition Multimedia Interface (HDMI) 10
- Horizontal Center 71
- Hue, adjusting 63

I

- Image Shift 79
- Infrared Receiver (IR) 15
- Inputs, labeling 79
- Iris 63, 65

J, K

- JUMP 54
- JUMP button 44

- L**
 Label
 Channels 73
 Label Video Inputs 79
 LAMP LED 15
 Lamp, replacing 86–89
 Language 79, 81
 Live Color 65
- M**
 MENU button 45, 49
 Menu Color 79, 81
 Movie Rating 76
 MTS 67
 MUTING button 44
- N**
 Noise Reduction 64
- O**
 Off, turning off the TV 15
 On, turning on the TV 15
- P, Q**
 Parental Control, described 9
 Parental Lock settings 62, 74
 Password, changing 75
 PC IN jack 17
 PC Input 65, 68, 71, 81
 Personal Computer
 connecting 40
 Phase 71
 Picture 63, 65
 PICTURE button 44
 Picture Mode
 Custom 63
 Standard 63
 Vivid 63
 Pitch 71
 POWER button 15
 Power Management 81
 POWER/STANDBY LED 15
 Problems, Troubleshooting 90–93
 Program Guide 52
 Program Options menu 52
- R**
 Ratings
 setting 76
 viewing blocked programs 75
 Remote control
 inserting batteries 43
 programming 47–48
 Removing channels from the
 channel list 72
 Removing the CableCARD 31
 Reset 63, 65, 66, 68
- S**
 S VIDEO jack, described 18
 Satellite receiver
 connecting 25
 Satellite receiver, using with
 remote control 49
 Screen settings 61, 69
 Select Country 75
 Settings
 Applications 62, 83
 Audio 61, 66
 Channel 62, 72
 Parental Lock 62, 74
 Screen 61, 69
 Setup 62, 78
 Video 61, 63
 Settings, WEGA GATE 56, 59
 Setup settings 62, 78
 Sharpness, adjusting 64
 Show/Hide Channels 72
 Sound Mode 66, 68
 Speaker 15, 67, 68
 Specifications 94–95
 Steady Sound
 adjusting 66
 described 10
 Support Belt 14
 Surround sound 66, 68
- T, U**
 Timer
 set current 84
 TIMER indicator 12
 TIMER LED 15
 Timer setting 83
 Treble, adjusting 66, 68
 Troubleshooting 90–93
- Turning on/off the TV 15
 TV FUNCTION button 44
 TV POWER button 45
 TV Rating 76
 TV/VIDEO button 15, 44
 U.S.A. Rating 77
 Unrated 76
- V**
 VCR
 using with remote control 49
 with cable box, connecting 35
 with cable, connecting 34
 Vertical Center 70, 71
 Vertical Size 70
 VHF/UHF jack, described 17
 Video 2 (Component) 79
 Video inputs, labeling 79
 Video settings 61, 63
 VIDEO/AUDIO (L/R) jacks,
 described 16, 18
 VISUAL SEARCH 45
 VOL +/- button 45
 VOLUME +/- button 15
 Volume Offset 66
- W, X, Y**
 WEGA GATE 9, 55
 WEGA GATE button 15
 Wide Mode 69, 71
 Wide Screen Mode, described 9



2597544111

<http://www.sony.net/>

Printed in U.S.A.
